



TA 6921 IND: Supporting Capacity Building Commission for Strengthening Institutional Capacities and Training Infrastructure – Transport Expert (56014-001)

ACBP

Ministry of Road Transport & Highways

Asian Development Bank

November 2023

Contents

1. Introduction.....	2
1.1. Study background.....	2
1.2. Mission Karmayogi or NPCSCB.....	2
1.3. Annual Capacity Building Plan (ACBP).....	3
1.4. Outline of the Report.....	5
2. Organizational Overview.....	6
2.1. Mandate.....	6
2.2. Goals and targets.....	10
2.3. Vision and Mission.....	15
2.4. Alignment with National Priorities.....	16
2.5. Knowledge Management Tools.....	17
2.6. Organogram.....	19
2.6.1. Organogram.....	19
2.6.2. Roles & responsibilities.....	20
3. Review of Existing Capacity.....	145
3.1. Existing Training Calendar.....	145
3.2. Root Cause Analysis.....	147
3.3. Recognition/ Motivation.....	148
4. Enabling Environment.....	149
4.1. Organizational Processes and Functioning.....	149
4.1.1. Business Processes, Protocols and SOPs followed.....	149
4.1.2. Personnel Management.....	150
4.1.3. Hard & Soft Infrastructure.....	152
4.1.4. Methods Adopted for External & Internal Communication, Citizen Outreach, Stakeholder Communication, etc.....	153
4.1.5. Knowledge Management.....	155
4.2. Business Process Evaluation.....	157
5. Capacity Building Plan.....	163
5.1. Approach & methodology.....	163
5.2. Competencies Identified and Capacity Building Interventions Suggested: Division Agnostic.....	164
5.3. Competencies Identified and Capacity Building Interventions Suggested: Division Specific.....	170
5.3.1. Road Wing.....	170
5.3.2. Road Transport Wing.....	178
5.3.3. Highways Wing.....	182

5.3.4.	Logistics Section	185
5.3.5.	Toll Division.....	187
5.3.6.	International Cooperation (IC) Division.....	188
5.3.7.	Finance Wing.....	189
5.3.8.	Administration Wing	191
5.3.9.	Transport research Wing (TRW).....	200
5.3.10.	Indian Academy of Highway Engineers (IAHE).....	201
6.	Proposed Training Calendar	203
7.	Monitoring and Evaluation Plan and Implementation Framework.....	213
7.1.	Framework for Monitoring and Evaluation Plan	213
7.2.	Monitoring and Evaluation Review Templates	215
	Annexures.....	216
	Annexure-1: Copy of OM of formation of Capacity Building Unit (CBU), MoRTH	216
	Annexure-2: Minutes of meeting of Kickoff meeting with CBU	217
	Annexure-3: Record of Discussion for Stakeholder Consultation Questionnaire with CBU	218
	Annexure-4: Key Schemes and Programmes	220

List of Tables

Table 1: Key institutions associated with MoRTH	8
Table 2: Goals and targets of MoRTH	11
Table 3: Knowledge Management Tools - MoRTH	17
Table 4: Root Cause Analysis of Competency Gap	147
Table 5: List of identified incentives/ motivations.....	148
Table 6: Business Process Evaluation	157
Table 7: Division-agnostic competency requirements.....	165
Table 8: Division-agnostic competency requirements	166
Table 9: Training Calendar - MoRTH	203

List of Figures

Figure 1: Institutional structure of Mission Karmayogi.....	2
Figure 2: Emerging Ecosystem of Civil Services Capacity Building.....	3
Figure 3: Conceptual Framework for Building of ACBP	4
Figure 4: Three pillars of CBP	5
Figure 5: Key functions of MoRTH	7
Figure 6: MoRTH's Vision and Mission	16
Figure 7: Organogram of MoRTH	20
Figure 8: Organogram of Regional Zones	21
Figure 9: Organogram - Planning Section	26
Figure 10: Organogram - S&R Section.....	31
Figure 11: Organogram - Monitoring Section.....	36
Figure 12: Organogram - EAP Zone.....	40
Figure 13: Organogram - MVL & Automotive Division	44
Figure 14: Organogram - Road Safety Division	48
Figure 15: Organogram - Transport Section.....	52
Figure 16: Organogram - Highways Division.....	57
Figure 17: Organogram - Land Acquisition Division	62
Figure 18: Organogram - Logistics Section	67
Figure 19: Organogram - Toll Division	72
Figure 20: Organogram - IC Division.....	77
Figure 21: Organogram - Finance & Budget Division.....	81
Figure 22: Organogram - EI Division.....	87
Figure 23: Organogram - EIB Division	91
Figure 24: Organogram - EII Division.....	95
Figure 25: Organogram - EIIB Division	99
Figure 26: Organogram - General Section	103
Figure 27: Organogram - Coordination Section	107
Figure 28: Parliament Section.....	111
Figure 29: Organogram - RTI Section	115
Figure 30: Organogram - CR Section	119
Figure 31: Organogram - O&M Section.....	122
Figure 32: Organogram - Cash Section.....	126
Figure 33: Organogram - Hindi Section.....	129
Figure 34: Organogram - Vigilance Section	133
Figure 35: Organogram - TRW.....	136
Figure 36: Organogram - IAHE.....	141
Figure 37: Training Calendar of IAHE - FY 2023-24.....	146
Figure 38: Overall Approach of Exercise	163
Figure 39: Consultation process adopted	164

1. Introduction

1.1. Study background

Public institutions play a key role in the governance of the country. The officials in these public institutions hold key positions of responsibility in performing wide range of tasks and duties ranging from planning, monitoring, formulation to implementation of policies/ schemes etc. thereby contributing towards building the nation and in achieving the national goals and targets. However, they face several institutional, organizational, and individual challenges in discharging their responsibilities in an efficient and effective manner. Therefore, it is essential to upskill the officials with strong and updated skillset, good practices of industry, trainings for overall development to make them more efficient in achieving the Vision & Missions of the country.

Mission Karma yogi or The National Program for Civil Services Capacity Building (NPCSCB) is a national program for capacity building of civil servants. The key objective of this mission is to support Ministry of Road Transport and Highways for preparation of an annual Capacity Building Plan (CBP) under NPCSCB in consultation with the Capacity Building Commission (CBC).

1.2. Mission Karmayogi or NPCSCB

Mission Karma yogi, a National Programme for Civil Services Capacity Building (NPCSCB) (the "Program") launched by the Union Cabinet, Government of India in September 2020, aims to build the capacity of Indian civil servants for the future based on the philosophy of creating an ecosystem of "competency driven training and human resource management by transitioning from a "rules-based" system to the "roles-based" system."

The Prime Minister's Public Human Resource Council (PMHRC), the program's apex body, is a part of the structure for the program's execution and supervision. A Cabinet Secretariat Coordination Unit under the apex body will oversee capacity building plans, coordinate stakeholders, and keep an eye on NPCSCB execution. For functional oversight of training institutions and to aid in the creation of yearly capacity building plans, a capacity building commission (CBC) has been established. For managing the digital assets developed by NPCSCB on behalf of the Government of India, an SPV (Special Purpose Vehicle) has been established.

Institutional structure of Mission Karmayogi

The following institutions have been created to operationalize the Mission:

1. PM's HR Council (PMHRC): Apex Body that provides strategic direction to the Mission

Figure 1: Institutional structure of Mission Karmayogi

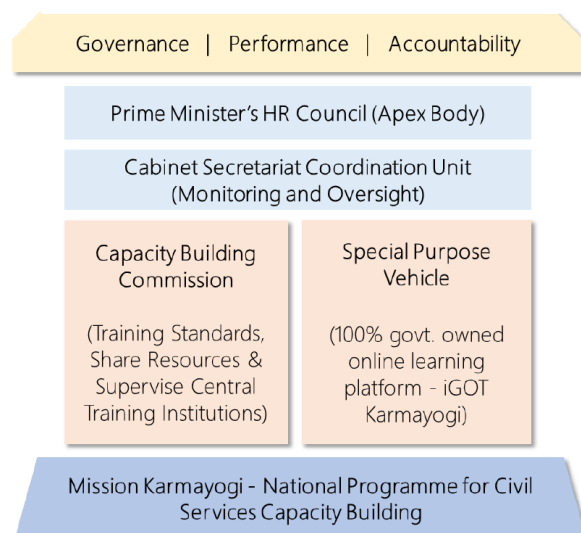

2. Cabinet Secretariat Coordination Unit: Monitors progress and oversees all capacity building interventions
3. Capacity Building Commission (CBC): Key implementing agency of Mission Karmayogi, suggests policy interventions related to HR practices, puts forth recommendations on standardization of training and capacity building, supervises all central training institutions
4. Special Purpose Vehicle: Owns and operates the online platform - iGOT Karmayogi - facilitating world class learning.

The Capacity Building Commission (CBC) was constituted in 2021 to fulfil the vision of Mission Karmayogi. An integral part of CBC's mandate is to facilitate preparation of Annual Capacity Building Plans (ACBPs) of Ministries, Departments, and Organizations (MDO) of the Government of India.

CBC is currently conceptualizing and developing capacity development plan for 30 MODs including Department for Promotion of Industry and Internal Trade. CBC has been interacting and working along with the ministries to chart out their goals, identify their competency requirement and preparation of their capacity development plan.

1.3. Annual Capacity Building Plan (ACBP)

The entire ecosystem of capacity building involves the complete lifecycle from annual capacity building plans to citizen centric training, engagements at summit, engagement with diverse training institutes, surveys and audits and the annual reporting.

The figure below shows the public services ecosystem that CBC sees evolving. As can be seen, the

Figure 2: Emerging Ecosystem of Civil Services Capacity Building

dem
and

for capacity building is driven by the development and implementation of ACBPs in all MDOs.

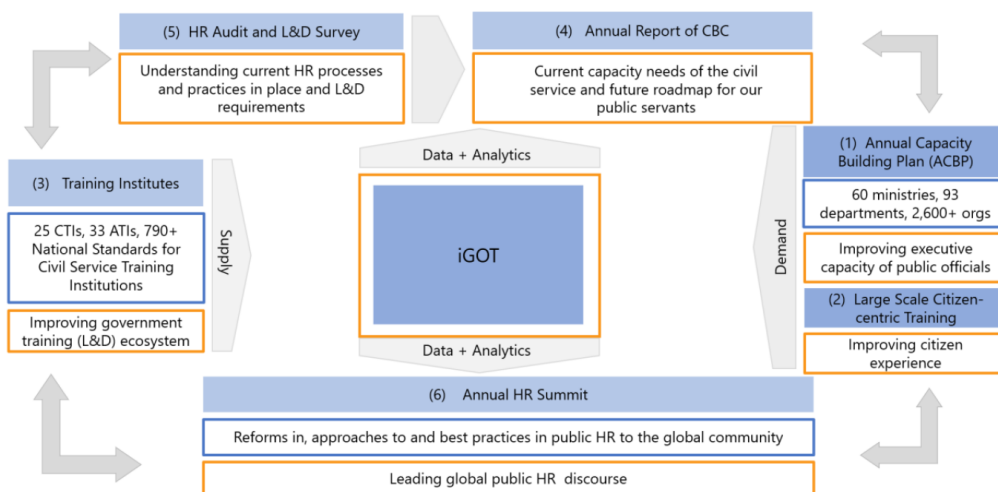

The purpose of development of the ACBP is to (i) understand and document capacity building needs at the individual, organizational and institutional levels and (ii) identify both training and other capacity building activities to address these needs.

ACBPs provide a detailed analysis of the individual and collective organizational needs of the MDO from which interventions are designed, implemented, and monitored.

Special training for citizen-centered behavior is envisaged such that it focuses on improving the experience of citizens when interacting with the state.

On the supply side, the focus is on improving the government's learning and development ecosystem. The CBC developed the National Standards for Civil Service Training Institutes (NSCTI) as a benchmark for measuring the current capacity of government training institutions.

The transformation of these institutes and centers of excellence is driven by targeted interventions in various priority areas such as staff development, training needs assessment, operations, and management.

An HR audit and learning and development survey will help gather insight into current HR processes and practices and future Learning and Development requirements.

This insight helps recommend improvement initiatives and is documented in the CBC's annual report. The insights gained from the data analysis of the iGOT Karmayogi platform are also the basis for CBC, HR Audit and the global discussion on public sector HR management and capacity development. India leads this global conversation by hosting an annual HR Summit.

Conceptual Framework for Development of Annual Capacity Building Plans

ACBP content is based on three lenses that focus on the field of capacity-building exercises and three pillars that cover the scope of capacity-building exercises. The figure below shows his three lenses for ACBP: National Priorities, Emerging Technologies, and Civic Centricity. It also shows the three pillars of ACBP: individual, organizational, and institutional capacity building.

Three Lenses: Focus areas for capacity building exercise

Capacity building is a goal-oriented exercise. Each MDO is expected to arrive at its own capacity building goals. To facilitate this process, the CBC has identified the following three focus areas: Contribution to National Priorities, Ability to assess Emerging Technologies, and Citizen-centricity.

Figure 3: Conceptual Framework for Building of ACBP

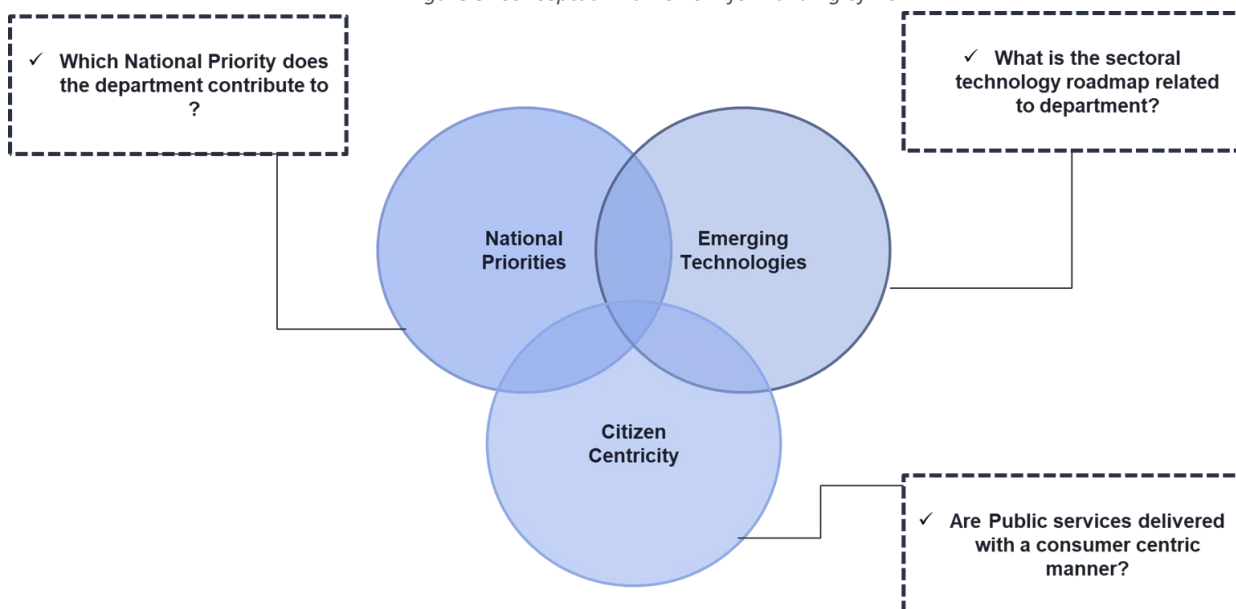

Three Pillars: Scope of capacity building exercise

Capacity is developed at three levels: individual, organizational, and institutional (as seen in figure 4). These are referred to as the three pillars of capacity building.

Figure 4: Three pillars of CBP

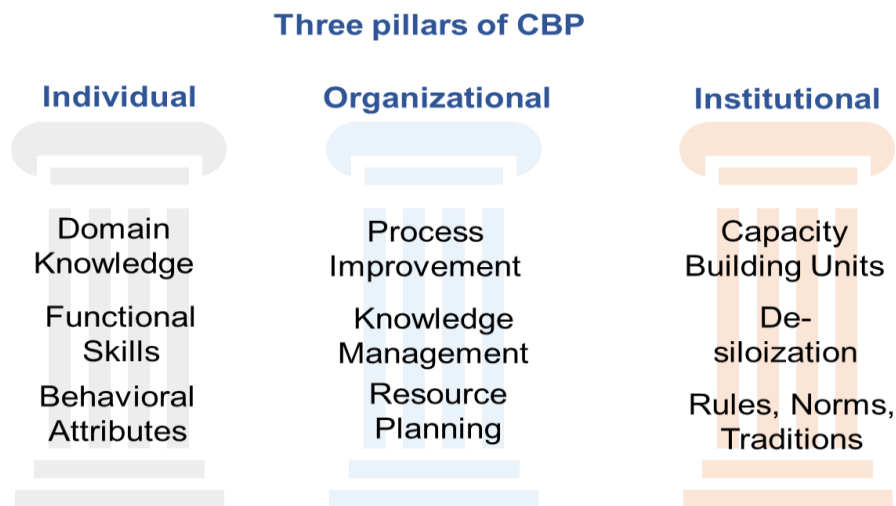

1.4. Outline of the Report

This report provides a broad overview of the vision and the goals of Department for Promotion of Industry and Internal Trade. In this regard, the subsequent chapters of the report cover the following:

About MoRTH

This section covers the functions, organizational structure and institutional set up of the Ministry. It further covers the key goals and targets, key schemes and programs, and other priorities in alignment with national goals and mission.

Divisional Roles and Responsibilities

For the overall vision of the department and the necessary background for the programme, this section elaborated the roles and responsibilities of the different departments/divisions of the department. Focuses and priorities for each department are defined along with key roles and responsibilities.

Adaptions to new innovations

This section covers the new innovations, plans and practices adopted by the Ministry for reduction in compliances and way forward towards more infrastructural development. The Ministry has formulated many policies and techniques for more citizen ease and accessibility.

Approach and Work Plan Methodology

Based on the overall approach adopted by the capacity building commission for preparation of annual capacity building plans, the approach and work plan are presented in the last chapter.

2. Organizational Overview

The Ministry of Road Transport & Highways (MoRTH) was formed in 2009 by bifurcating the erstwhile Ministry of Shipping, Road Transport and Highways into two independent Ministries, i.e., Ministry of Road Transport & Highways and Ministry of Shipping. MoRTH is the apex organization under the Central Government with role and responsibility to increase the mobility and efficiency of the road transport system and strengthening the road network of the country. It also aids in administration of Central Road Fund, and formulation and implementation of the policies relating to road transport.



सड़क परिवहन
एवं राजमार्ग मंत्रालय
MINISTRY OF
**ROAD TRANSPORT
AND HIGHWAYS**

This section aims to present an introduction about the Ministry of Road Transport & Highways including:

- Mandate, roles, and functions of the Ministry
- Key institutions associated with the Ministry
- Vision, mission, priorities, and goals
- Organizational structure of the Ministry
- Roles & responsibilities of each Wing/ Division

2.1. Mandate

“The tasks and responsibilities of the Ministry of Road Transport and Highways encompass, inter alia, construction and maintenance of National Highways (NHs); administration of the National Highways Act, 1956; National Highways Authority of India Act, 1988; National Highways Fee (Determination of Rates and Collection) Rules, 2008; Motor Vehicles Act, 1988; and Central Motor Vehicles Rules 1989, as also formulation of broad policies relating to road transport and automotive norms, besides making arrangements for movement of vehicular traffic with neighboring countries.”

Along with this the Ministry sets to achieve, development both at urban and rural level by increasing connectivity, providing ease of mobility to people, and creating a safer space for motorists by ensuring road safety. The Ministry is undertaking several schemes related to National Highways across the country and Road Safety. MoRTH is headed by the Minister (Road Transport and Highways) along with the Minister of State. The administrative head of MoRTH is the Secretary who is supported by officials at various levels as described in more details in sections below.

Website - <https://morth.nic.in/>

Roles and responsibilities

- MoRTH functions as the apex body for the development of National Highways across the country. Further it has various related bodies and organizations to support in roles and functions such as NHAI, NHIDCL, IAHE, IRC etc. Some major roles and functions of MoRTH are planning, policy formulation, development, and maintenance of National Highways, providing technical and financial support to state government, setting guidelines for roads and bridges, monitoring the on-going projects, and necessary amendments in relevant acts from time to time, green transport, handling logistics, enhancing private sector participation.
- It is also responsible for Motor Vehicle Legislation i.e., Automotive norms for road transport including vehicular compliances, safety, registration, licenses, permits, analysis of road accidents and schemes for road safety, improving road transport, provide grants to non- governmental organizations, administration of Road Transport Corporation Act, 1950 and Motor Vehicle Act, 1988.

- It provides training in highway engineering, and other subjects related to highway development, construction, and management through autonomous body IAHE.
- Some other key roles and functions of MoRTH include:
 - (i) As per the list 1 of the SEVENTH SCHEDULE to the CONSTITUTION OF INDIA are:
 - a) Compulsory insurance of motor vehicles.
 - b) Administration of the Road Transport Corporations Act, 1950 (64 of 1950).
 - c) Highways declared by or under law made by Parliament to be national highways.
 - d) Issuance of notifications under clause (a) of section 3 and sections 3A, 3D, 7 and section 8A of the National Highways Act, 1956 (48 of 1956) without being scrutinized and vetted by the Legislative Department.
 - (ii) With Respect to Union Territories:
 - a) Roads other than National Highways.
 - b) Administration of the Motor Vehicles Act, 1988 (59 of 1988) and taxation of motor vehicles.
 - c) Vehicles other than mechanically propelled vehicles.
 - (iii) Other important subjects:
 - a) Coordination and Research pertaining to Road Works. 9. Road works financed in whole or in part by the Central Government.
 - b) Motor vehicles legislation.
 - c) Promotion of Transport Co-operatives in the field of motor transport.
 - d) Formulation of the privatization policy in the infrastructure areas of roads.
 - e) Coordination, research, standards, and policy matters in respect of ropeways and other innovative/alternative mobility solutions
 - (iv) Important Acts:
 - a) National Highways and Infrastructure Development Corporation Ltd. VII. ACTS:
 - b) The Road Transport Corporations Act, 1950 (64 of 1950).
 - c) The National Highway Act, 1956 (48 of 1956).
 - d) The Motor Vehicles Act, 1988 (59 of 1988).
 - e) The National Highways Authority of India Act, 1988 (68 of 1988).

Figure 5: Key functions of MoRTH

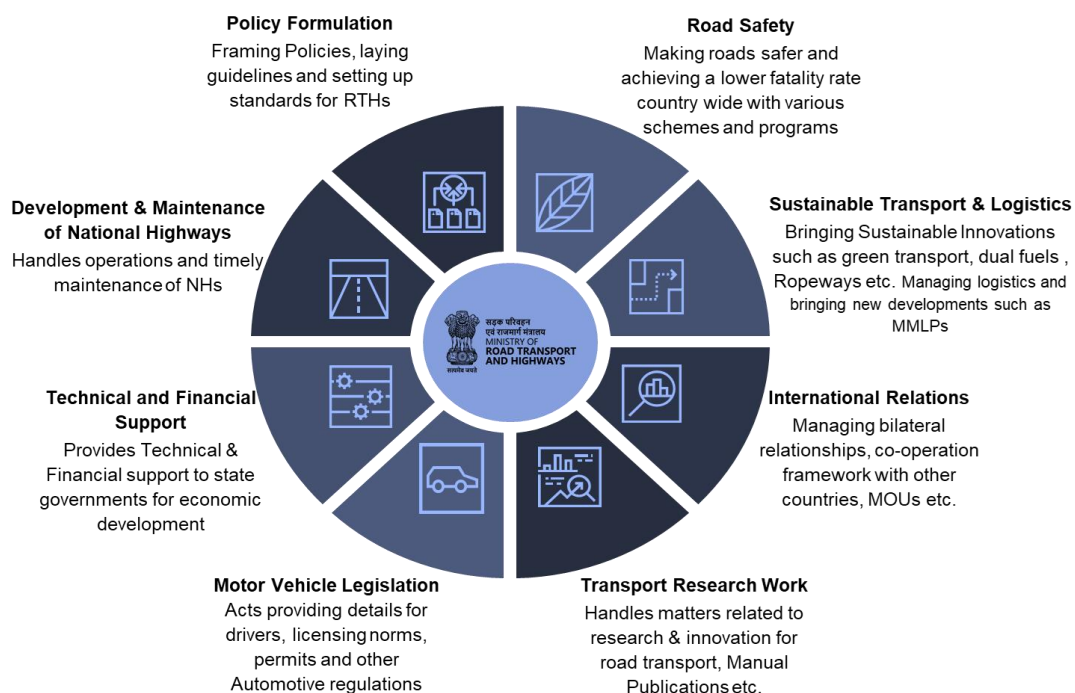

Key institutions associated with the Ministry

The Ministry has a network of 3 autonomous bodies and 5 related organizations for ease of service provision and efficiently discharges its roles and responsibilities in the development, management and regulation of roads, highways, and the transport sector. Each autonomous body and related organization have a separate vision, mission, and set of key objectives. The details of each body/organization are given below:

Table 1: Key institutions associated with MoRTH

S. No	Name of the organization	Details	Webpage Address
Autonomous Bodies			
1.	National Highways Authority of India (NHAI)	<ul style="list-style-type: none"> Operational since 1995. It is responsible for development, maintenance, and management of national highways. It looks after all the contracts and ensures that all projects are awarded with good practices such as transparency in the processes and adoption of bid criteria to maintain healthy competition for bidders. Mandate - To implement National Highway Development Project (NHDP). It is divided into 7 phases. Under NHDP, major focus lies on better safety, carriageways, improved road geometry, better bridges, and underpasses etc. Other projects include Baramulla and Parvatmala for development of Roads, Highways, and introduction of Ropeways. Vision - To meet the nation's needs to develop, maintain, and promote a growth in global network within the strategic policy framework Mission - To develop, maintain, manage and collect toll from National Highways and advise central government on matters related to highways. 	https://nhai.gov.in/#/
2.	National Highways & Infrastructure Development Corporation of India Limited (NHIDCL)	<ul style="list-style-type: none"> Operational since March' 2014. The company deals with designing, building, operating and maintenance of highways with an aim to create more economically integrated transport system. Alongside national development it is also focusing on business development opportunities at global level. Mandate - To carry out construction, up-grading, widening of National Highways in parts of the country which share international boundaries with other countries to promote regional connectivity. Vision - Creation and management of high standard infrastructure with specific focus on North- East and Border areas. Mission - To design, develop and deliver infrastructure projects and maximize benefits for stakeholders 	https://nhidcl.com/
3.	Indian Academy of	<ul style="list-style-type: none"> Operational since 1983. 	http://www.iahe.org.in/index.htm

S. No	Name of the organization	Details	Webpage Address
	Highway Engineers (IAHE)	<ul style="list-style-type: none"> It is the premium academy for imparting knowledge with subjects related to construction of bridges, highways, and other similar areas. It handles overall growth of the individual. Mandate - To provide trainings to the Highway Engineers in the country for both public and private domain. It is a premium institute dealing with skill buildup of infrastructural workforce. Vision - To upskill the project personnel for better delivery of projects Mission - To promote exchange of knowledge in the domain of highways engineering within India as well as cross - country. 	
Related Organizations			
4.	Indian Road Congress (IRC)	<ul style="list-style-type: none"> Operational since November 1934. It is an apex body of engineers and industry professionals. It has approx. 5 million associates including both public and private. It handles periodic road conferences to discuss issues related to road safety, road construction and maintenance. Mandate - To be professional and be multi-faceted institution for road sector related matters. Vision - To focus on effective transport system and promote zero road crashes and to align with global initiative of sustainable environment goals Mission - To promote expertise on subjects related to road sector, policy issues on construction and road transportation 	https://www.irc.nic.in/
5.	CSIR - Central Road Research Institute (CRRRI)	<ul style="list-style-type: none"> Operational since 1952. It is a key center for research and development in various areas. It has 37 National Laboratories, 39 outreach centers, 1 innovation complex, and three other units. It covers a wide range of research topics such as biotech, nanotech, environmental engineering etc. Mandate - To carry out research and development in all aspects of road transport, road safety and transport economics etc. Vision - To become a global leader to integrate research, development, and innovation in the transport sector Mission - To nurture scientific talent, and repository for innovative technical solutions 	https://crridom.gov.in/
6.	Automotive Research Association of India (ARAI)	<ul style="list-style-type: none"> Operational since 1966, It is the prime automotive research organization set up in the country. It is recognized as a Scientific and Industrial Research Organization (SIRO). It has a well-trained team of more than 	https://www.araiindia.com/

S. No	Name of the organization	Details	Webpage Address
		<p>700 human resources. It is affiliated to the Ministry of Heavy Industries and Public Enterprises.</p> <ul style="list-style-type: none"> • Mandate - To ensure, safe and less polluting and reliable vehicles. It focuses on e-mobility. • Vision - To foster world class mobility, engineering research and innovation • Mission - Create and facilitate safe, smart, and sustainable mobility solutions 	
7.	Central Institute of Road Transport (CIRT)	<ul style="list-style-type: none"> • Operational since 1967, • It is a joint initiative of Ministry of Shipping and Transport and a close association of State Transport Undertakings. It offers Management Development Programs which includes general management, transport operations and maintenance engineering. All programs have different durations, and the courses are fully residential. • Mandate - To increase efficiency and productivity of the transport sector with special emphasis on STU (State Road Transport Undertakings). It is into service for 45 years. It is recognized by various international agencies such as UNDP and British Council. • Vision - To strengthen the transport sector by conducting training sessions and building up skills. • Mission - To achieve an efficient transport system. To achieve this, they have various set of trainings to skills the individuals in transport domain. 	http://www.cirtindia.com/
8.	National Highways Logistics Management Limited (NHLML)	<ul style="list-style-type: none"> • Operational since January 2004, it is a Special Purpose Vehicle of NHAI with 100% ownership. • Mandate - To enhance development of Multi Modal Logistics Parks (MMLPs), inter model station, ropeways, and port connectivity. It is currently working on the plan of approx. 35 MMLPs across the country. • Vision - Facilitation of high standard coordination system through planning and proper management • Mission - To promote sustainable coordination, achieve, CSR goals, to improve deliveries, building valuable relationships with stakeholders. 	http://nhlm.in/

2.2. Goals and targets

The Ministry has taken strong efforts to contribute towards the overall growth of the country's infrastructure and create a global benchmark. Various plans, policies and schemes have been launched to achieve its goals and targets. Several Declarations have also been signed as a step towards

environmental protection and improving road safety. Some key goals, initiatives and targets of the Ministry are as follows –

Table 2: Goals and targets of MoRTH

S. No	Goals /Initiatives/ Targets	Description	Achievement Plan
Key Goals			
1.	Maintenance of National Highways	Development and Maintenance of National Highways is an important measure to ensure smooth connectivity. Usually, NHAI is responsible along with its other related organisations such as NHIDCL, NHLML etc.	<ul style="list-style-type: none"> • Every fiscal year, the government of India allocates budget estimate to provide revenue for maintenance and repair of National Highways. • The ministry allocated approx. Rs 768 crores during FY22-23 for periodic renewal and Improvement of Riding Quality Program (IRQP) works related to National Highways. • Funds are also allocated to states as per the ongoing project demands. The regional authorities take up further action plans for the development based on traffic density and the available funds.
2.	Implement e-Office at MoRTH (Paperless Organization)	MoRTH has vision to move from a pen and paper-based work environment to become a paperless organization. With the implementation of e-office, most of the tasks can be managed online.	<ul style="list-style-type: none"> • The 80% e-office target set by the Ministry of Administrative Reform and Grievances has long been met. More than 92% of his work in the ministry now takes place in the e-office. • All e-office issues/ complaints are handled in a timely manner. The administration, human resources, technical, project and finance departments communicate very smoothly with each other via e-Office. Tracking files has become an easier task. MoRTH strives to achieve the goal of a paperless organization.
3.	Promote e-Mobility	MoRTH aims to achieve efficient infrastructure through introduction of e-Mobility. New technologies and innovation space is created to implement new modes of transport.	<ul style="list-style-type: none"> • MANTHAN, a three-day national conference and exhibition was conducted by Ministry to create space for discussions around multiple opportunities in technology and innovation domain. • The expo showcased developments and latest technologies related to construction machinery, new building materials, logistics management and the EV sector. • Faster Adoption and Manufacturing of Hybrid & Electric Vehicles (FAME) Scheme is a program designed as part of the 2020 National Electric Mobility Mission Plan (NEMMP) to provide incentives to promote hybrid and electric vehicles in the country.

S. No	Goals /Initiatives/ Targets	Description	Achievement Plan
4.	Formulate Automotive Norms	Creating strong vehicular laws and regulations to maintain an efficient transport system in the country.	<ul style="list-style-type: none"> Acts such as Motor Vehicle Act, 1988, the law details provisions relating to driver/conductor licensing, motor vehicle registration, motor vehicle management by permit, special provisions for state transport companies, traffic rules, insurance, liability, criminal offenses, and penalties, etc.
5.	Formulate and implement Scrapping Policy	Registered Vehicle Scrapping Facility	<ul style="list-style-type: none"> The Voluntary Vehicle Scrapping application provides vehicle owners with the ability to seamlessly phase out new, old and/or unsuitable vehicles. It helps boost the automobile sector and controls pollution from vehicles. The move also encourages the establishment of testing centers and fitness centers. Evaluate the condition of the vehicle at the junkyard and scrap the vehicle. Vehicle owners may voluntarily choose to dispose of damaged/unusable vehicles under state or federal law regulations. This feature is available online for vehicles registered with VAHAN. A Certificate of Delivery (CD) is issued to the vehicle owner who submits the vehicle for disposal. CDs can be used for trading. There are also economic benefits. A Scrap Vehicle Certificate (CVS) is issued upon completion of the vehicle dismantling and disposal process.
6.	Expansion of connectivity in difficult terrains and affected areas such as NER region and LWE	Ministry has a goal to achieve i.e., to increase connectivity in difficult terrains and a	<ul style="list-style-type: none"> Various development programs and schemes are developed for increasing connectivity in NER and LWE areas. NHAI has been developing highways for better connectivity in these areas.
Key Targets			
1.	Construction of MMLPs to strengthen infrastructure	MMLPs – Multi Modal Logistics Park, a multipurpose warehouse alongside National Highways. Target of 35 MMLP projects in the initial phase.	<ul style="list-style-type: none"> Cabinet Committee on Economic Affairs (CCEA) has also mandated MoRTH for the construction of MMLPs. They will be developed under PPP and DBFOT as the mode of implementation. Currently most of the projects are under feasibility phase and no execution work has started.
2.	Reduction in road injuries and fatalities	The Government of India reaffirmed its commitment in Stockholm declaration to reduce road fatalities & injuries by	<ul style="list-style-type: none"> Ministry is working on various initiatives along all 4Es of road safety including

S. No	Goals /Initiatives/ Targets	Description	Achievement Plan
		50% by the year 2030. Accordingly, Ministry is working on developing strategies with a long-term vision supported by interim targets for reducing the number of road fatalities.	<p>Engineering (Road & Vehicle), Enforcement, Education and Emergency Care.</p> <ul style="list-style-type: none"> • In 2019, Motor Vehicle (Amendment) Act was enacted with specific interventions targeted towards safety of drivers, vehicles, and infrastructure. • Several notifications have been issued for improved enforcement and vehicle safety. • Electronic Detailed Accident Report (e-DAR) project has been launched to act as central repository of road accidents in the Country, to further help in data analysis and strategy formation.
3.	Introduction to Ropeways - Parvatmala Project	Project "Parvatmala" has been launched to increase the scope of Ropeways in India. The target of 8 ropeway projects of overall length of 60 km in last Financial Year.	<ul style="list-style-type: none"> • Feasible means of transport for areas where mass transit is not possible such as mountains etc. • Economic mode of transport can be driven on single power plant. • Flexible and low carbon footprint Faster mode of transfer and environment friendly • Many projects are under pipeline and soon to be implemented.
4.	Ease of licensing	<p>Ministry is working on ease of application of driving license. The aim is to make the procedure accessible for citizens.</p> <p>Further, Ministry aims to do driving test of all licenses through an automated</p>	<ul style="list-style-type: none"> • The application forms are now divided into 4 categories – learner license, driving license, renewal of driving license, and updating of address. • The forms can be accessed online followed by a small Aadhar Verification Step.
5.	Reduction in emissions – Sustainable Transport	One of the key goals of the Ministry is to take a step towards environmental protection. Focus has been increased on e-mobility and use of dual fuels and many more new initiatives.	<ul style="list-style-type: none"> • Dual fuel usage has been advised by the Ministry that covers smoke from tractors and other construction equipment. • Green Highways Policy was launched in 2015 to develop 140,000 km long "treeline" with plantation along both sides of national highways. • National Policy on Biofuels with target of 20% blending of biofuels, both for biodiesel and bioethanol. Currently the ethanol blending percentage in petrol is 10.0% and biodiesel blending percentage in diesel is less than 1%.
6.	Greenfield Expressways	MoRTH targets to complete specified greenfield expressways by FY24-25.	<ul style="list-style-type: none"> • Some key expressways are – <ul style="list-style-type: none"> ○ Delhi – Mumbai Expressway 1,386 km ○ Ahmedabad – Cholera 109 km ○ Bengaluru – Chennai 262 km ○ Delhi – Amritsar – Katra 669 km

S. No	Goals /Initiatives/ Targets	Description	Achievement Plan
			<ul style="list-style-type: none"> o Kanpur – Lucknow Expressway 63 km
7.	Controlled Corridors	Ministry targets to develop controlled corridors by FY24-25.	<ul style="list-style-type: none"> • Some key corridors are – <ul style="list-style-type: none"> o Raipur – Vishakhapatnam 465 km o Hyderabad Visakhapatnam 222 km o Chennai – Salem 277 km o Chittoor – Thatchur 116 km o Bangalore Ring Road 280 km o Delhi – Saharanpur – Dehradun 239 km o Durg Raipur Arang 92 km o Hyderabad – Raipur 335 km o Surat – Nashik – Ahmednagar – Solapur 719 km o Solapur – Kurnool – Chennai 340 km o Indore – Hyderabad 525 km o Kharagpur – Siliguri 235 km • Kota Indore (Garoth to Ujjain) 135 km
8.	Accessible India Campaign (Sugamya Bharat Abhiyan)	To provide accessibility of transport for person with disability	<ul style="list-style-type: none"> • The campaign is based on the principles of A social model of disability that refers to the fact that disability is caused by the way society is It is organized and not based on human limitations or disabilities. physical, social, structural Employment barriers that prevent people with disabilities (Divyangjan) from participating on an equal footing socio-cultural and economic activities. Must complete all his STUs as part of the campaign. • The goals of the Accessible India Campaign are to: • 25% of state public transit should be fully accessible. March 2019 • All bus stops/terminals/ports should be accessible for people with various disabilities. • Facilities for expedited licensing and registration may be provided to persons with disabilities.
9.	Increasing Port Connectivity	India has a total of 226 ports including 12 major ports. There are currently 87 working Implementation ports under consideration for connectivity evaluation, or Capacity expansion. Improve first/last mile connectivity to all major and minor ports country.	<ul style="list-style-type: none"> • To ensure proper last mile connectivity to all domestic operational/UI ports, A comprehensive port connection master plan has been prepared by MoRTH. • As part of Masterplan, connectivity requirements for all operational and implementation ports. • Specifically, operational/implemented ports, 55 port connections and A related hinterland project with a total length of 2,779 km has already been initiated by the government. Ministries and their implementing agencies.

S. No	Goals /Initiatives/ Targets	Description	Achievement Plan
10.	International Initiatives and cooperation	Ministry's Division – International Cooperation handles international relationships and developments across borders. The Ministry has signed various MOUs with Japan, Korea, UAE, USA etc.	Some Key initiatives are – <ul style="list-style-type: none"> • India-Japan Joint Working Group – highlighted progress made in roads and transport technologies and potential for cooperation between the two countries. • Bangladesh, Bhutan, India, and Nepal (BBIN) Motor Vehicles Agreement (MVA) – To facilitate passenger, cargo, and vehicle movement between BBIN countries. • Meetings between Ministry and US delegates to work on capacity building and road safety. • Meetings between Ministry and Brazilian delegates to work on biofuels and new fuel technologies. • MoRTH also participates in various international platforms such as SCO, UNESCAP and other multilateral agencies.

2.3. Vision and Mission

The Ministry's Vision is to have a sustainable, efficient, safe, and internationally comparable quality of road infrastructure in general and National Highways infrastructure to achieve enhanced connectivity, quick mobility to a level which accelerate socio-economic development.

Figure 6: MoRTH's Vision and Mission

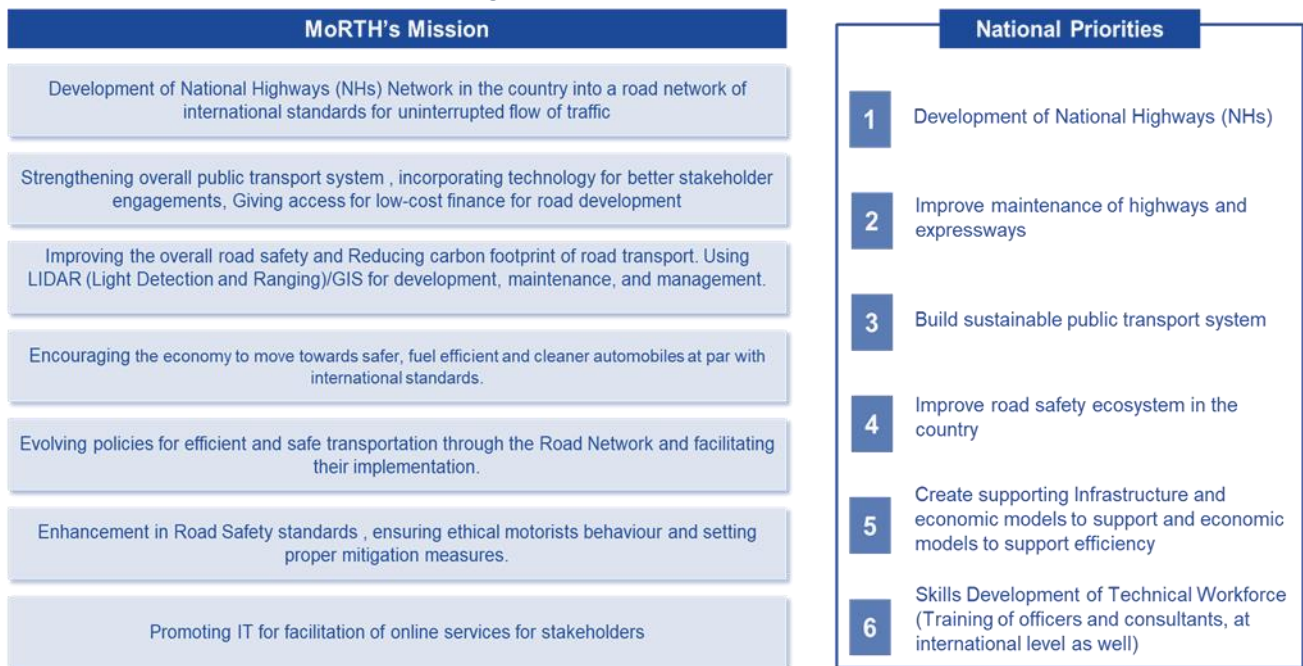

2.4. Alignment with National Priorities

- Development of National Highways** – MoRTH is responsible for development of National Highways in both Urban/ Rural areas to increase connectivity. The Ministry has announced various projects such as Delhi- Mumbai Industrial Corridor (DMIC), which is under construction. The Special Purpose Vehicle (SPV) for the project will be held responsible for timely completion of the project. Other Important projects include Bharatmala Pariyojna, which targets to build a vast network of Flyover, tunnels, underpasses, economic corridors etc. The project is divided into phases and completion of Phase 1 has been achieved by 2022.
- Improve maintenance of highways and expressways** – Ministry has taken various initiatives for maintenance of highways and expressways. Every year the Ministry allocates funds for the Maintenance and Repair (M&R) works and Periodic Renewal (PR) of National Highways. Other programmes such as Improvement of Riding Quality Programme (IRQP) works for maintenance and repairs of National Highway.
- Build sustainable public transport system**– One of the growth mandates of MoRTH corresponds to sustainable development, in particular making of Green Highways (Plantation, Transplantation, Beautification and Maintenance) Policy, 2015. The aim of the policy is to promote greenery around Highway Corridors with support from both National, State and Regional Institutions. Plans and Policies have also been discussed for the introduction of another Sustainable mode of Transport namely Ropeways. It can be proposed as a successful mode of transfer on difficult terrains such as mountains. The capital expenditure is lesser and hence returns are higher on this. No pollution is generated and is environment friendly. A Memorandum of Understanding (MOU) has been signed with Government of Uttarakhand to develop Ropeways at 7 main point locations.
- Improve road safety ecosystem in the country** – With rapid expansion of the road network, increasing number of vehicles and increase in average speed on roads, India is also witnessing a high number of road accidents and fatalities. This is not only leading to significant human suffering,

but also draining the GDP of the Country by claiming lakhs of economically productive lives. Some key initiatives undertaken by Ministry to promote Road Safety are – Enactment the Motor Vehicle (Amendment) Act in 2019 which includes several interventions targeted towards improving the safety of drivers, vehicles and road infrastructure, observance of 32nd National Road Safety Week, issuance of notifications for safety of road users and vehicles etc. To increase sensitivity and awareness among the stakeholders many other educational measures are also taken such a where participation from both public and private institution is required. Schemes such as Road Safety Advocacy Scheme and Good Samaritan Scheme and Identification of black spots are some of the good practices initiated by the Ministry to reduce the road fatality rates.

- **Create supporting infrastructure and economic models to support and economic models to support efficiency** – To promote a well-developed transport model in the country the Ministry ensures to build supporting infrastructure such as MMLPs, Ropeways Projects, Foot Over bridges, Heavy Bridges, Tunnels, Flyovers, Underpasses, Subways, Industrial Corridors etc. For better efficiency stringent laws are also an essential requirement that the Ministry full fills by strengthening the Motor Vehicle Act year,1988. Focus of this Act is to bring reforms in the road safety areas, to reduce corruption with the help of new IT Practices and remove intermediaries. It will allow testing on innovation technologies on ground level and promote Divyang to access motors in a suitable form.
- **Skills Development of Technical Workforce** – While MoRTH is focusing on achieving all its goals, mission, and vision, one important development aspect covers the skill building of the related individuals. Capacity building of the stakeholders and the workforce is highly essential. Various training programmes are conducted for NHA employees, Field workers, and other engaged stakeholders to spread safety awareness. Ministry also works in close association with many driving schools to increase the driving competency of the motorists on road and avoid accidents. IAHE plays a major role in skill development of individuals at both global and national level.

2.5. Knowledge Management Tools

In line with technological developments over the years, the Ministry of Roads and Highways has innovated various knowledge management tools for managing programs, monitoring projects, promoting traffic safety awareness, collecting accident data, and managing day-to-day office operations, is institutionalized. The table below shows the main features of the tools currently in operation and under consideration by the Ministry.

Table 3: Knowledge Management Tools - MoRTH

S. No.	KM Tool	Key Features
1.	Vahan	<ul style="list-style-type: none"> • https://vahan.parivahan.gov.in/nrservices/ • mVahan is designed as a convenient mobile solution to manage various VAHANs Services of departmental officers of RTOs and other internal stakeholders like traders. • The current version available on the Android platform facilitates several processes including Automate vehicle inspection and condition, facilitating dealer/RTO document upload during vehicle registration and other services, such as processing address change requests, etc. • The functions are further expanded to include all RTO functions.
2.	eChallan & Intelligent Traffic	<ul style="list-style-type: none"> • https://echallan.parivahan.gov.in/

S. No.	KM Tool	Key Features
	Management System (ITMS)	<ul style="list-style-type: none"> Several states and smart cities have introduced intelligent traffic management systems for the modernization of the traffic management system. As part of this, advanced technologies/components such as closed-circuit television/automatic number recognition, cameras, speed guns, speeding detection (OSVD) / red light violation detection. For effective monitoring of traffic violations, (RLVD) devices etc. have been installed. Information captured by these systems is an integrated eChallan Traffic Enforcement Solution for Issuance of challan notices to defaulters in a non-invasive manner.
3.	VLTS Command & Control Centre Solution	<ul style="list-style-type: none"> https://brvlts.parivahan.gov.in/ Vehicle Location Tracking and Emergency Alert System is Implemented by MoRTH across the country. The whole system is based on AIS-140. The Ministry that defines the process of installing an approved positioning system equipment in common vehicles and creation of a VLTS Command and Control Center at the state level. NIC has developed a complete solution that includes device attachment and compatibility through the system through the VLTD Maker application and create and use the software. The center monitors all vehicles equipped with the devices.
4.	Bharat Series Vehicle Registration	<ul style="list-style-type: none"> This feature is only available for new vehicle registrations through dealer registration. This The facility of registration of "Bharati Series (BH Series)" vehicles is available on a voluntary basis Defense personnel, central government/state administration/central office/state public sector employees. Industrial companies and private sector companies/organizations with offices in the quarter or more states/union territories. Currently, BH series registration is active in 25 states/UTs.
5.	Vehicle Recall Management System	<ul style="list-style-type: none"> Vehicle Recall Management System is being facilitated to handle every. aspect of vehicle recall, including customer notification and response mechanism, Process Tracking, compliance, and reporting, among other necessary stages of the cycle. It may also take care of recall events triggered by retrofitting requirements in vehicle(s).
6.	Automatic Fitness Management System/Automated Testing System	<ul style="list-style-type: none"> https://vahan.parivahan.gov.in/AFMS will provide motor vehicle owners ability to book vehicle tests, view test results, apply for re-test and appeal against first test result. Automated Testing System (ATS) operators will be able to manage test bookings 56 and generate test results. The results of the application are linked to Vahan.
7.	NextGen mParivahan Mobile App	<ul style="list-style-type: none"> To facilitate citizen convenience and improve accessibility, the great program is NextGen mParivahan was developed by MoRTH in collaboration with NIC's eTransport division, bringing together all transport-related features, functions, and related utilities into a single platform. The application is created by linking various services of Vahan, Sarathi, eChallan etc. via API binding.

S. No.	KM Tool	Key Features
8.	SARATHI	<ul style="list-style-type: none"> • https://sarathi.parivahan.gov.in/SarathiReport/sarathiHomePublic.do • For the ease of license application this tool has been implemented. All types of license forms are available on the online platform.

2.6. Organogram

2.6.1. Organogram

The Hon'ble Minister heads the Ministry of Road Transport & Highways (RT&H) supported by Minister of State, Secretary (RT&H) and Director General (Roads Development). The administrative head of MoRTH is the Secretary (RT&H) who is supported by other senior officers such as Additional Secretaries, Joint Secretaries, Senior Adviser (Transport Research), and other Secretariat/Technical Officers at the level of Directors/Deputy Secretaries, Under Secretaries, and others. Assisting the Secretary (RT&H) in drafting and processing all policies and other proposals with financial matters is an Additional Secretary & Financial Adviser (AS&FA) handling the Finance Wing

The Ministry is organized into various Wings in alignment with the functions of the Ministry. These Wings are led by officers with the rank of Additional/Joint Secretaries or Chief Engineers, and are staffed by Directors, Deputy Secretaries, Under Secretaries and other officers with comparable ranks who serve as Wings heads. The Wings have various Divisions/Sections/Zones under them to cater to various functions of the Wing. Further down, Divisions are classified into various Sections for handling specific functions. A Section Officer, who heads a section, is supported by two or three dealing hands, primarily Assistant Section Officers and other supporting staffs. The Under Secretaries and the officers under them perform various tasks based on the nature of the assignments assigned to them that can vary based on the priority of the assignment and adequacy of the workforce. The workforce numbers vary across each wing.

Engineers and Technical Officers are a part of the hierarchy of technical Wings for example in the Roads Wing and other Technical Wings. Technical Officers from the economic and statistical streams constitute the staff of Wings like Transport Research Wing (TRW) for handling the economic advisory and other data related decisions.

The organogram of the Ministry along with its key officers is given below:

Figure 7: Organogram of MoRTH

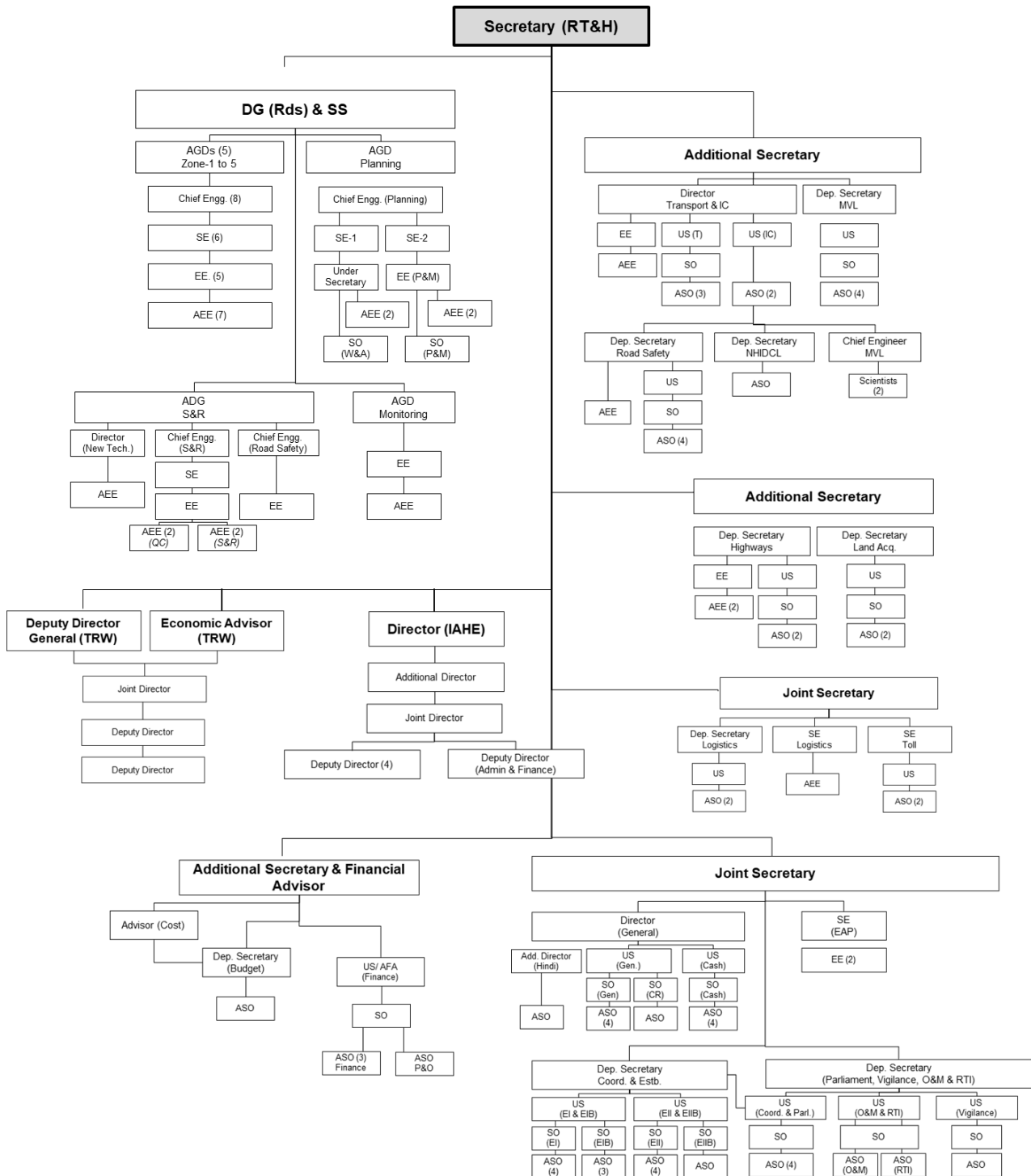

2.6.2. Roles & responsibilities

This section captures the roles and responsibilities of the various key divisions and undertakings of the Ministry.

2.6.2.1. Road Wing

The Road Wing plays a key role in the overall execution, monitoring, and completion of projects across India. It is divided into various zones. Each zone has a specific responsibility. The Road Wing, in addition to the Director General (Roads), has technical officers at the level of Chief Engineers,

Superintending Engineers, and other Engineering/Technical Staff, as well as five Additional Directors General (ADGs). Since the responsibility of the Roads wing is the undertake project across the country, therefore it is sub divided into various zones namely to oversee projects and other activities in the respective zones.

Currently there are Five zones, each headed by an ADG who, oversees the work of developing and maintaining National Highways and other nationally supported road works for three or more States. There are Zones for Planning, Monitoring, Standard Research & Technology etc. These are headed by ADGs as well.

The Road Wing is headed by Director General (Roads) who works in close association with other technical and secretarial officers. The structure of the road wing, which consists of five zones and 3 Sections–

- Regional Zones (Zone-1, Zone 2, Zone -3, Zone-4, Zone -5)
- Planning Section
- Standards and Research (S&R) Section
- Monitoring Section
- EAP Zone

a) Regional Zones

Regional Project zones includes five zones. Each zone is responsible for the jurisdiction matters of some respective states. The key focus areas and roles and responsibilities are listed in the below in the table along with work allocation matrix.

Regional Zones Zone-1, Zone 2, Zone -3, Zone-4, Zone -5, and their jurisdiction of states as given below.

- Zone-1 Jurisdiction–U. P., Uttarakhand, Bihar, Jharkhand
- Zone-2 Jurisdiction' Chandigarh, Haryana, H.P., J&K, Punjab, Delhi, Rajasthan.
- Zone-3 Jurisdiction' Andhra Pradesh, Telangana, Kerela, Lakshadweep Islands, Puducherry, Tamil Nadu, Odisha, Andaman & Nicobar Islands.
- Zone-4 Jurisdiction. Chhattisgarh, Madhya Pradesh, Maharashtra, Karnataka, Goa, Daman & Diu.
- Zone-5 Jurisdiction. All eight States of North-eastern Region, Gujarat, Dadra & Nagar Haveli, West Bengal, Sikkim.

Each Regional Zone is headed by an Additional Director General (ADG). The organogram of Regional Zones is given below:

Figure 8: Organogram of Regional Zones

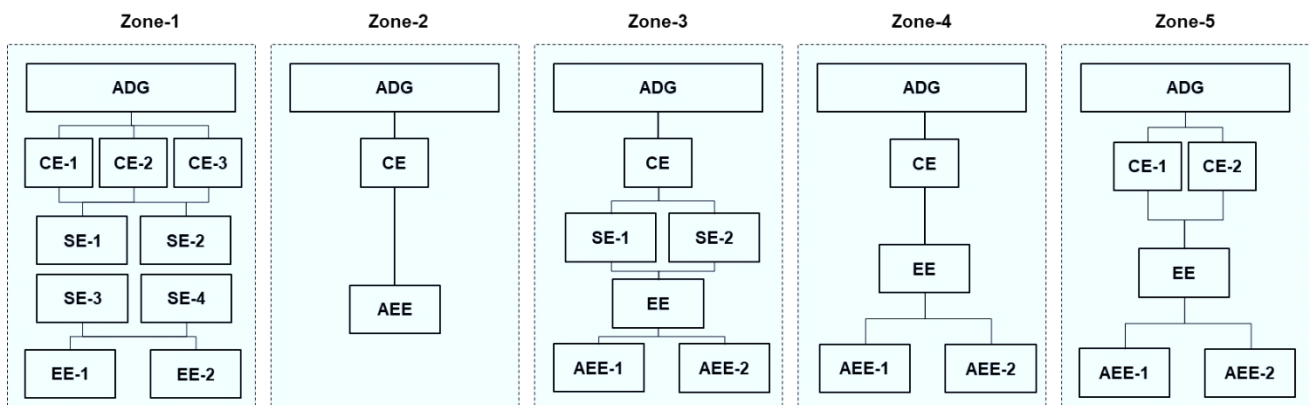

Key focus areas

- Development and maintenance of National Highways
- Other centrally sponsored road works.
- Road safety engineering works

Role of Regional Zones

Regional zones are responsible for development, maintenance of National Highways, Handles centrally sponsored road works, Planning, Monitoring, Standards & Research (S&R), Administration of Central Road Fund (CRF).

- All the work of the Road Wing has been divided into various project zones each headed by Additional Director General (ADG)
- In the Zones, section level units provide secretarial support.
- All projects under their purview, i.e., handling all project-related inquiries and managing projects from conception to completion. Regarding NHs and other roads, there are audit paras, inquiries in the Parliament, inspection reports, PAC references, Consultative Committee items, VIP references, and RTI applications.
- Conducting routine inspection and monitoring of all ongoing projects within their purview, including the three times yearly monitoring of projects with counterparts in the States in accordance with a schedule established by the Planning and Monitoring Zone, and providing the Planning Zone with all information pertaining to project monitoring.
- Appointment of consultants for feasibility assessments of newly proclaimed NHs in accordance with standard TOR in their respective States.
- BOT projects for the creation and upkeep of NHs, including all active BOT projects and projects receiving outside assistance.
- Construction and maintenance of all NHs, including bridges in the States and UTs.
- Approval of initial/revised estimates, flood damages, special repairs, NH maintenance and repair, and other tenders.
- Handling of CCEA, EFC, PIB, arbitration, and court proceedings.
- Reports from the regional officers and engineer liaison officers.
- The execution of license documents for cables, water pipes, and gas pumps, etc.
- Concerns with any projects that Border Roads Organization has been given in the relevant States.
- Completing estimates for significant bridge rehabilitation on national highways.

Roles and functions of various officer levels:

Designation	Role and functions
ADG	<ul style="list-style-type: none"> ○ Oversee and manage all activities related to the development and maintenance of National Highways within the assigned regional zone. ○ Provide leadership and direction to the project zones within the region. ○ Handle project-related inquiries and manage projects from conception to completion. ○ Conduct routine inspections and monitoring of ongoing projects within the purview of the regional zone. ○ Address audit paras, inquiries in Parliament, inspection reports, PAC references, Consultative Committee items, VIP references, and RTI applications.
CE	<ul style="list-style-type: none"> ○ Manage the construction and maintenance of National Highways, including bridges, in the states and union territories within the regional zone. ○ Approve initial/revised estimates, flood damages, special repairs, NH maintenance and repair, and other tenders. ○ Handle appointments of consultants for feasibility assessments of newly proclaimed NHs in the respective states. ○ Supervise the execution of license documents for cables, water pipes, gas pumps, etc.

Designation	Role and functions
	<ul style="list-style-type: none"> Coordinate with other divisions for BOT projects, including approval and management of active BOT projects and projects receiving outside assistance.
SE	<ul style="list-style-type: none"> Regularly review and monitoring of ongoing projects within the assigned region. Supervise the construction and maintenance of National Highways, bridges, and other road infrastructure. Handle the approval of initial/revised estimates, flood damages, special repairs, NH maintenance and repair, and other tenders. Assist in the appointment of consultants for feasibility assessments of newly proclaimed NHs in the respective states. Manage reports from regional officers and engineer liaison officers.
EE	<ul style="list-style-type: none"> Oversee the execution of specific projects of national highways Coordinate with consultants and contractors for feasibility assessments and project execution. Handle project-related inquiries and manage projects from conception to completion. Assist in routine inspections and monitoring of ongoing projects within the purview of the regional zone. Participate in handling arbitration and court proceedings related to projects.
AEE	<ul style="list-style-type: none"> Provide administrative and technical support for various tenders, approvals, and documentation from the headquarters. Support the coordination with consultants, contractors, and field officers for project execution. Handle project-related inquiries and administrative tasks remotely. Assist in the remote monitoring of ongoing projects within the assigned region. Collaborate with regional officers and liaison officers to manage reports and inquiries efficiently.

Based on the roles and functions, the domain competencies identified across various officer levels are:

Domain Competencies	ADG	CE	SE	EE	AEE
Highway development including engineering, cost estimation, construction, and monitoring					
Maintenance of National Highways including planning, engineering, implementation, and monitoring					
Quality control and assurance					
Road safety engineering and audit					
Relevant acts, regulations and guidelines published by the government					
Contract management and administration					
Arbitration and dispute resolution					
Latest practices and technologies related to design, construction, maintenance & materials used in highways					
Procurement of works, services, and consultancy					
Bridge and Tunnel engineering					

Level of intervention as per competency need assessed

High	Moderate	Low
------	----------	-----

The behavioural and functional competencies mapped for the section are the follows:

Type	Competencies	ADG	CE	SE	EE	AEE
Functional	Central Portals (e-office, NIC Portal, Grievance Portal, VIP Portal, Bhoomirashi Portal and any other relevant portal)	High	Moderate	Moderate	Moderate	High
	MS Office (Word, PowerPoint, Excel)	Moderate	Moderate	Moderate	High	High
	Government documentation (noting, drafting, cabinet notes, parliamentary answers, reports, Memorandum of Understanding etc.), reporting for parliamentary procedures, questions, and RTI queries	High	Moderate	Moderate	Moderate	High
	Financial procedures/ GFR/ Bill clearances/ PFMS	High	Moderate	Moderate	Moderate	High
	GRM (Grievance Redressal Mechanism), CPGRAMs and INGRAMs Portals	High	Moderate	Moderate	High	High
	Government procurement protocols, processes, and tools (RFP, Tender Evaluation, Tender Award, Government e Marketplace - GeM) etc.)	Moderate	Moderate	Moderate	Moderate	High
Behavioural	Verbal communication; Liaisoning and Negotiation skills	High	Moderate	Moderate	Moderate	Moderate
	Multitasking and time management	Moderate	Moderate	High	High	High
	Administrative and managerial skills	Moderate	Moderate	Moderate	High	High
	Stakeholder and people management	High	Moderate	Moderate	Moderate	Moderate
	Gender sensitization and anti-sexual harassment	Moderate	Moderate	Moderate	Moderate	Moderate
	Organizational skills (such as planning, delegation, knowledge of key responsibility areas, goal setting, team building etc.)	High	Moderate	Moderate	Moderate	Moderate
	Health and well-being, and stress management	High	High	High	Moderate	Moderate
	Adaptation to new skills and methodologies	High	High	High	High	High

Level of intervention as per competency need assessed

High	Moderate	Low
------	----------	-----

Training Need Assessment:

Type	Competency	Training Need Assessment
Domain	Highway development including engineering, cost estimation, construction, and monitoring	<ul style="list-style-type: none"> Basic to intermediate training to all officers (SE & below)
	Maintenance of National Highways	<ul style="list-style-type: none"> Basic to intermediate training to all officers (SE & below)

	including planning, engineering, implementation, and monitoring	
	Quality control and assurance	<ul style="list-style-type: none"> • Basic training to senior officers (CE & below) • Advanced training to officers (SE & below)
	Road safety engineering and audit	<ul style="list-style-type: none"> • Refresher training to senior officers (CE & below) • Advanced training (followed by refresher training) to officers (SE & below)
	Relevant acts, regulations and guidelines published by the government	<ul style="list-style-type: none"> • Induction material to be provided to all Officers
	Contract management and administration	<ul style="list-style-type: none"> • Advanced training to all officers. Regular workshops may be conducted as well.
	Arbitration and dispute resolution	<ul style="list-style-type: none"> • Advanced training to all officers. Regular workshops may be conducted as well.
	Latest practices and technologies related to design, construction, maintenance & materials used in highways	<ul style="list-style-type: none"> • Regular advanced training for all officers
	Procurement of works, services, and consultancy	<ul style="list-style-type: none"> • Training to be provided to Officers (SE & below)
	Bridge and Tunnel engineering	<ul style="list-style-type: none"> • Advanced training to all Officers (CE & below)
Functional	Central Portals (e-office, NIC Portal, Grievance Portal, VIP Portal, Bhoomirashi Portal and any other relevant portal)	<ul style="list-style-type: none"> • Trainings on portals should be provided as part of induction/ refresher trainings to increase functional efficiency of the staff members.
	MS Office Skills (Word, PowerPoint, Excel)	<ul style="list-style-type: none"> • Trainings on MS office should be provided for better documentation, report writing, data management etc. • Advanced training to US and below. • Refresher/ induction training should be provided for all new joiners.
	Government documentation (noting, drafting, cabinet notes, parliamentary answers, reports, Memorandum of Understanding etc.), reporting for parliamentary procedures, questions, and RTI queries	<ul style="list-style-type: none"> • Trainings on Government documentation, protocols, processes, etc. should be provided to all staff members.
	Financial procedures/ GFR/ Bill clearances/ PFMS	<ul style="list-style-type: none"> • Basic knowledge of GFR/ Financial bills and operation of PFMS portal should be provided to all new joiners and other officers in position.
	GRM (Grievance Redressal Mechanism), CPGRAMs and INGRAMs Portals	<ul style="list-style-type: none"> • Trainings on portals should be provided as part of induction/ refresher trainings to increase functional efficiency of the staff members.
	Government procurement protocols, processes, and tools (RFP, Tender Evaluation, Tender Award, Government e Marketplace - GeM) etc.)	<ul style="list-style-type: none"> • Trainings on Government documentation, protocols, processes, understanding of tender, GeM portals etc. should be provided to all staff members.
Behavioural	Verbal communication; Liaisoning and Negotiation skills	<ul style="list-style-type: none"> • Communication trainings should be provided to all officer up to CE level.
	Multitasking and time management	<ul style="list-style-type: none"> • Trainings on multitasking and time management to be conducted for all officials to maintain healthy work life balance. • Advanced training for senior officers.
	Administrative and managerial skills	<ul style="list-style-type: none"> • To run an efficient team, training should be provided for enhancing the managerial skills of the section staff. It will increase the sense of decision making, communication, strategic planning etc. • Senior officials such as SE and above should be provided with

		advanced level trainings to upskill.
	Stakeholder and people management	<ul style="list-style-type: none"> • Trainings to handle and negotiate with stakeholders both internal and external shall be provided to the staffs for ease knowledge transfer through means of communication.
	Gender sensitization and anti-sexual harassment	<ul style="list-style-type: none"> • Such interpersonal trainings should be conducted at regular intervals and these trainings should be mandatory for all designations.
	Organizational skills (such as planning, delegation, knowledge of key responsibility areas, goal setting, team building etc.)	<ul style="list-style-type: none"> • Regular upskilling required to enhance organizational skills for all employees (particularly senior officers) to delegate matters effectively,
	Health and well-being, and stress management	<ul style="list-style-type: none"> • Trainings on balancing health to be provided to officers of all level.
	Adaptation to new skills and methodologies	<ul style="list-style-type: none"> • Regular upskilling is essential to pace up with the existing technological advancements and hence trainings should be provided to all officials to increase adaptability to new technologies and their operating procedures.

b) Planning Section

Planning Section is headed by an Additional Director General. Some of the key focus areas and roles/ responsibilities are discussed below.

Key focus areas

- Design & alignment of highways
- Administrative grant allocation
- Technical training of officers

Role of Planning Section

- Normal Planning works (Five Year Plan and Annual Plan of Central Sector Roads, Long-term Plans, Working Groups for Five Year Plans) including allocation of funds.
- Policy matters relating to general issues of road development such as resources mobilization and financing and other policy matters except those mentioned in the duties of CE (PIC).
- All matters relating to NH Acts and NH Rules. Agreements between the Central and the State Governments.]
- Matters relating to IRCC.
- Ribbon Development and General legal and constitutional issues affecting all classes of roads.
- Declaration fixing alignment, entrustment and transfer with regard to National Highways to the State Governments, National Highways Authority of India (NHAI) and Border Roads Organisation (BRO).
- Project preparation for four laning including appointment of consultants.
- Misc. work relating to references relating to foreign countries such as agreement, treaties, meeting with foreign Govt/bodies ASIAN HIGHWAYS, SAARC, ESCAP, PIARC, IRC, IABSE, membership with National and international organisations and associations & Road development in foreign countries. (Overall coordination in the Ministry will be with IC Wing)

Figure 9: Organogram - Planning Section

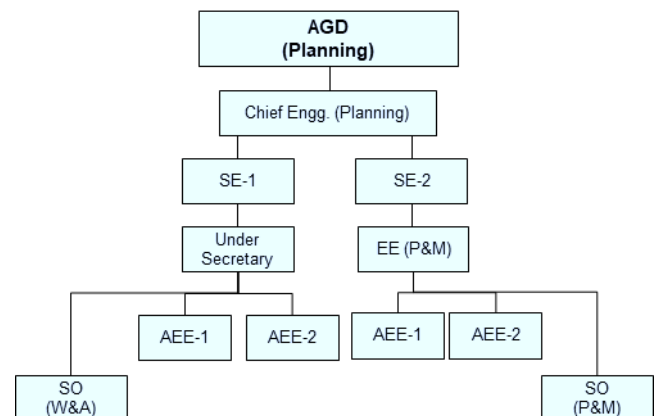

- All matters including administration grants appointments, meeting nomination/deputation of engineers to trainings, seminars workshops, conferences etc. in India and abroad including JICA (Bilateral with Japan) training and CRRI (except budget). (In the case of participation in training programmes in India and abroad, of the officers and staff of this Ministry and its attached/subordinate/regional offices, associate offices, autonomous bodies and PSUs, the decisions on nominations will be taken by Admn/Estt Wing.)
- All matters including administration, grants, appointments, meeting and training (except Budget) in respect of Indian Academy of Highway Engineers (IAHE).

Roles and functions of various officer levels:

Designation	Role and functions
ADG	<ul style="list-style-type: none"> ○ Provide strategic leadership and oversight for the Planning Section, ensuring effective implementation of planning activities. ○ Manage and coordinate the normal planning works, including the Five Year Plan and Annual Plan for Central Sector Roads. ○ Handle policy matters related to road development, resource mobilization, financing, and other general policy issues. ○ Oversee matters related to NH Acts and NH Rules, agreements between Central and State Governments, and issues concerning IRCC. ○ Coordinate and provide guidance on legal and constitutional issues affecting various classes of roads.
CE	<ul style="list-style-type: none"> ○ Supervise and approve the allocation of funds for planning activities, including the Five Year Plan and Annual Plan. ○ Provide technical expertise and guidance on project preparation for four-laning, including the appointment of consultants. ○ Manage matters related to the declaration, alignment fixing, entrustment, and transfer of National Highways to State Governments, NHAI, and BRO. ○ Oversee planning activities related to Ribbon Development and address general legal and constitutional issues affecting all classes of roads. ○ Ensure compliance with NH Acts and NH Rules, and coordinate agreements between Central and State Governments.
SE	<ul style="list-style-type: none"> ○ Conduct reviews and assessments of planning activities, including the Five Year Plan and Annual Plan. ○ Supervise the preparation of projects for four-laning and coordinate the appointment of consultants. ○ Address legal and constitutional issues affecting various classes of roads within the purview of planning. ○ Coordinate matters related to the declaration, alignment fixing, entrustment, and transfer of National Highways. ○ Provide technical support for policy matters related to road development and resource mobilization.
EE (P&M)	<ul style="list-style-type: none"> ○ Assist in the preparation and implementation of planning activities, including the Five Year Plan and Annual Plan. ○ Support the project preparation for four-laning, including the coordination of consultant appointments. ○ Address legal and constitutional issues related to road development within the planning section. ○ Assist in matters related to the declaration, alignment fixing, entrustment, and transfer of National Highways. ○ Provide technical input and support for policy matters affecting road development.
SO	<p>SO (W&A)</p> <ul style="list-style-type: none"> ○ Handle administrative tasks within the Planning Section, including budgetary allocations and expenditure monitoring. ○ Handle financial matters related to the Works & Accounts section.

Designation	Role and functions
	<ul style="list-style-type: none"> Maintain financial records for ongoing projects, including tracking expenses and revenues. Coordinate with project managers and engineers to ensure accurate and timely financial reporting. Provide regular updates on financial performance to higher authorities. <p>SO(P&M)</p> <ul style="list-style-type: none"> Assist in the coordination of planning activities, ensuring adherence to timelines and guidelines. Manage contracts and agreements related to Works & Accounts. Manage matters related to NH Acts, NH Rules, and agreements between Central and State Governments. Coordinate meetings, appointments, and training programs for engineers within the Planning Section. Oversee administrative matters related to IAHE and other training initiatives.
US	<ul style="list-style-type: none"> Assist in the coordination of planning activities, including the preparation of the Five Year Plan and Annual Plan. Manage administrative tasks related to budgetary allocations, expenditure monitoring, and general office coordination. Handle documentation and communication related to NH Acts, NH Rules, and agreements between Central and State Governments. Coordinate meetings, appointments, and training programs for engineers within the Planning Section.
AEE	<ul style="list-style-type: none"> Provide administrative and technical support for planning activities, including the Five Year Plan and Annual Plan. Assist in the preparation of projects for four-laning and coordinate consultant appointments. Address administrative matters related to declarations, entrustments, and transfers of National Highways. Support the coordination of legal and constitutional issues affecting various classes of roads within the planning section. Provide assistance in the overall execution of planning-related tasks.

Based on the roles and functions, the domain competencies identified across various officer levels are:

Domain Competencies	ADG	CE	SE	EE	AEE	SO
Highway Design, Construction and Maintenance						
Data Analysis and processing						
Road safety engineering and audit						
Relevant acts, regulations and guidelines published by the government						
Contract management and administration						
Arbitration and dispute resolution						
Latest practices and technologies related to design, construction, maintenance & materials used in highways						
Project Appraisal and Feasibility Analysis						

Level of intervention as per competency need assessed

High	Moderate	Low
------	----------	-----

The behavioural and functional competencies mapped for the section are the follows:

Type	Competencies	ADG	CE	SE	EE	AEE	SO
Functional	Central Portals (e-office, NIC Portal, Grievance Portal, VIP Portal, Bhoomirashi Portal and any other relevant portal)	Low	Moderate	Moderate	High	High	High
	MS Office (Word, PowerPoint, Excel)	Moderate	Moderate	Moderate	High	High	High
	Government documentation (noting, drafting, cabinet notes, parliamentary answers, reports, Memorandum of Understanding etc.), reporting for parliamentary procedures, questions, and RTI queries	Low	Moderate	Moderate	High	High	High
	Financial procedures/ GFR/ Bill clearances/ PFMS	Low	Moderate	Moderate	Moderate	Moderate	High
	GRM (Grievance Redressal Mechanism), CPGRAMs and INGRAMs Portals	Low	Moderate	High	High	High	High
	Project Management, controlling and reporting including various project management tools and techniques.	Moderate	Moderate	High	High	High	Low
	Government procurement protocols, processes, and tools (RFP, Tender Evaluation, Tender Award, Government e Marketplace - GeM) etc.)	Moderate	Moderate	Moderate	High	High	High
Behavioural	Verbal communication; Liaisoning and Negotiation skills	Low	Moderate	Moderate	Moderate	Moderate	Moderate
	Multitasking and time management	Moderate	Moderate	Moderate	Low	Low	Low
	Administrative and managerial skills	Moderate	Moderate	Moderate	Moderate	Moderate	Moderate
	Stakeholder and people management	Low	Moderate	Moderate	Moderate	Moderate	Moderate
	Gender sensitization and anti-sexual harassment	Moderate	Moderate	Moderate	Moderate	Moderate	Moderate
	Organizational skills (such as planning, delegation, knowledge of key responsibility areas, goal setting, team building etc.)	Low	Low	Low	Moderate	Moderate	Moderate
	Health and well-being, and stress management	Moderate	Moderate	Moderate	Moderate	Moderate	Moderate
	Adaptation to new skills and methodologies	High	High	High	High	High	High

Level of intervention as per competency need assessed

High	Moderate	Low
------	----------	-----

Training Need Assessment:

Type	Competency	Training Need Assessment
------	------------	--------------------------

Domain	Highway Design, Construction and Maintenance	<ul style="list-style-type: none"> Basic training to all officers
	Data Analysis and processing	<ul style="list-style-type: none"> Advanced training to officers (SE & below)
	Road safety engineering and audit	<ul style="list-style-type: none"> Basic training to all technical officers
	Relevant acts, regulations and guidelines published by the government	<ul style="list-style-type: none"> Induction material to provided to all employees
	Contract management and administration	<ul style="list-style-type: none"> Advanced training to all technical officers. Regular workshops may be conducted as well.
	Arbitration and dispute resolution	<ul style="list-style-type: none"> Advanced training to all technical officers. Regular workshops may be conducted as well.
	Latest practices and technologies related to design, construction, maintenance & materials used in highways	<ul style="list-style-type: none"> Advanced training to all officers
	Project Appraisal and Feasibility Analysis	<ul style="list-style-type: none"> Advanced training to all officers (CE & below)
Functional	Central Portals (e-office, NIC Portal, Grievance Portal, VIP Portal, Bhoomirashi Portal and any other relevant portal)	<ul style="list-style-type: none"> Trainings on portals should be provided as part of induction/ refresher trainings to increase functional efficiency of the staff members. (CE & Below)
	MS Office Skills (Word, PowerPoint, Excel)	<ul style="list-style-type: none"> Trainings on MS office should be provided for better documentation, report writing, data management etc. Advanced training to US and below.
	Government documentation (noting, drafting, cabinet notes, parliamentary answers, reports, Memorandum of Understanding etc.), reporting for parliamentary procedures, questions, and RTI queries	<ul style="list-style-type: none"> Trainings on Government documentation, protocols, processes, etc. should be provided to all staff members. (CE & below)
	Financial procedures/ GFR/ Bill clearances/ PFMS	<ul style="list-style-type: none"> Basic knowledge of GFR/ Financial bills and operation of PFMS portal should be provided to all new joiners and other officers in position.
	GRM (Grievance Redressal Mechanism), CPGRAMs and INGRAMs Portals	<ul style="list-style-type: none"> Trainings on portals should be provided as part of induction/ refresher trainings to increase functional efficiency of the staff members.
	Government procurement protocols, processes, and tools (RFP, Tender Evaluation, Tender Award, Government e Marketplace - GeM) etc.)	<ul style="list-style-type: none"> Trainings on Government documentation, protocols, processes, understanding of tender, GeM portals etc. should be provided to all staff members. (CE & below)
Behavioural	Verbal communication; Liaisoning and Negotiation skills	<ul style="list-style-type: none"> Communication trainings should be provided to all officer up to CE level.
	Multitasking and time management	<ul style="list-style-type: none"> Trainings on multitasking and time management to be conducted for all officials to maintain healthy work life balance. Advanced training for senior officers.
	Administrative and managerial skills	<ul style="list-style-type: none"> To run an efficient team, training should be provided for enhancing the managerial skills of the section staff. It will increase the sense of decision making, communication, strategic planning etc. Senior officials such as SE and above should be provided with advanced level trainings to upskill.
	Stakeholder and people management	<ul style="list-style-type: none"> Trainings to handle and negotiate with stakeholders both internal and external shall be provided to the staffs for ease

		knowledge transfer through means of communication.
	Gender sensitization and anti-sexual harassment	<ul style="list-style-type: none"> Such interpersonal trainings should be conducted at regular intervals and these trainings should be mandatory for all designations.
	Organizational skills (such as planning, delegation, knowledge of key responsibility areas, goal setting, team building etc.)	<ul style="list-style-type: none"> Advanced training to EE & below Basic training to be provided to all officers on regular basis
	Health and well-being, and stress management	<ul style="list-style-type: none"> Trainings on balancing health to be provided to officers of all level.
	Adaptation to new skills and methodologies	<ul style="list-style-type: none"> Trainings should be provided to all officials to increase adaptability to new technologies and their operating procedures.

c) S&R Section

This Section covers the planning responsibilities of the schemes and other guidelines as required in the Road Wing. The key focus areas and roles & responsibilities have been discussed below.

Figure 10: Organogram - S&R Section

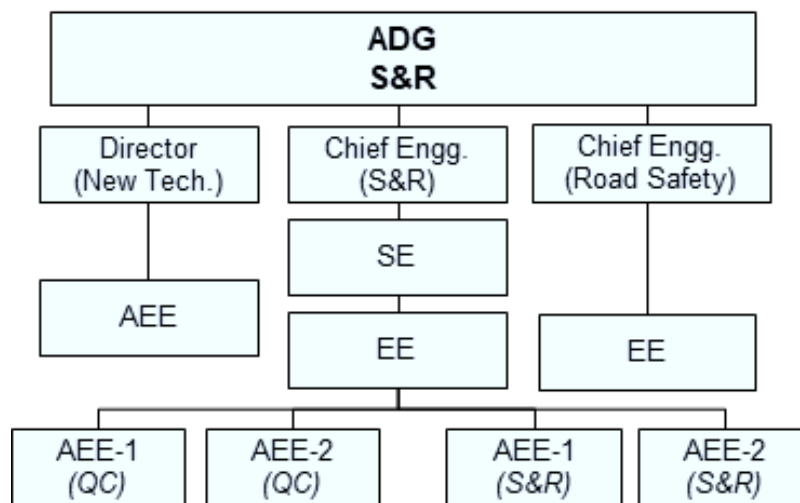

Key focus areas

- Research
- Planning
- Coordination and Cooperation
- Development of National Highways

Role of S&R Section

- Identifying Research areas and sanction of schemes, issuing guidelines, circulars in highway sector, Updating and giving valuable insights, Highways Capacity Augmentation Studies and development of Highways & Bridge Management System, training related issues of Indian Academy of Highway Engineers, Circulars relating to new material and techniques.
- Determining the areas of investigation and investigation and sanctions related to roads and roads bridges.

- Planning for monitoring and budget coordination of all standard and Research in Roads Wing schemes.
- Monitoring of the investigation of ongoing R&D schemes and finalization of Inception Report/Interim Reports, Final Reports and Draft Final Reports and related matters, release of funds etc.
- Works related to the revision of technical specifications and the update of the road and bridge engineer's manual.
- References of States/Project Zones/Others etc. related to interpretation of specifications, standard guidelines etc.
- Coordination & Cooperation with IRC, HRB, BIS and other committees related to road infrastructure.

Roles and functions of various officer levels:

Designation	Role and functions
ADG	<ul style="list-style-type: none"> ○ Provide strategic leadership and oversight for the Standards & Research Section. ○ Ensure alignment of research activities with the overall goals and objectives of the Ministry. ○ Foster collaboration with national and international agencies, organizations, and research institutions. ○ Represent the Ministry in conferences, workshops, and forums to promote standards and research initiatives. ○ Evaluate and recommend the adoption of new technologies and innovations in the road transport sector. ○ Implement and oversee quality assurance processes for standards and research activities.
CE (Road Safety)	<ul style="list-style-type: none"> ○ Establish and communicate the vision and goals for road safety within the organization. ○ Contribute to the formulation and review of road safety policies and regulations. ○ Stay abreast of national and international best practices to enhance road safety standards and share the same with relevant stakeholders at central and state level ○ Oversee the monitoring and evaluation of road safety programs and interventions. ○ Analyze data on road accidents, identify trends, and recommend measures for improvement.
CE (S&R)	<ul style="list-style-type: none"> ○ Provide technical guidance and expertise for standards and research activities within the section. ○ Ensure that engineering standards are consistently applied and maintained in road infrastructure projects. ○ Oversee compliance with established standards in the design, construction, and maintenance of roads and highways. ○ Conduct regular audits to ensure adherence to technical specifications.
Director (New Technology)	<ul style="list-style-type: none"> ○ Assess and evaluate emerging technologies relevant to road transport and infrastructure. ○ Provide expert recommendations on the feasibility and potential impact of adopting new technologies ○ Foster partnerships with technology companies and industry stakeholders to facilitate the integration of new technologies. ○ Contribute to the development of regulatory frameworks and standards for the use of new technologies in the road sector. ○ Disseminate knowledge about new technologies through publications, workshops, and training programs.
SE	<ul style="list-style-type: none"> ○ Provide technical oversight for standards and research projects in the assigned area. ○ Ensure that engineering standards are consistently applied in the planning and execution of projects.

Designation	Role and functions
	<ul style="list-style-type: none"> Coordinate with project managers, engineers, and external partners to ensure the successful execution of research projects. Monitor progress and address any technical challenges that arise. Implement quality control measures to ensure the accuracy and reliability of research outcomes. Prepare technical reports on research findings and project outcomes.
EE (S&R)	<ul style="list-style-type: none"> Execute and manage specific components of research projects under the guidance of senior engineers. Ensure that project activities align with established timelines and quality standards. Maintain comprehensive documentation of project activities, methodologies, and outcomes. Ensure that project documentation meets internal and external reporting requirements. Provide technical support to project teams, assisting in the planning and execution of research initiatives.
EE (Road Safety)	<ul style="list-style-type: none"> Analyze data related to road accidents, traffic violations, and safety measures. Prepare comprehensive reports on road safety performance and trends for management and regulatory authorities. Support Chief Engineer (Road Safety) in implementation of identified road safety initiatives
AEE	<ul style="list-style-type: none"> Provide support to engineers and researchers in the planning and execution of research projects. Assist in literature reviews, data collection, and preliminary analyses. Assist in maintaining project documentation, ensuring accuracy and completeness. Support the preparation of reports, presentations, and technical documents. Collaborate with internal and external stakeholders involved in standards and research activities. Facilitate effective communication and coordination throughout the project lifecycle.

Based on the roles and functions, the domain competencies identified across various officer levels are:

Domain Competencies	ADG	CE	Director	SE	EE	AEE
Highway Design, Construction and Maintenance				High	High	High
Data Analysis and processing			Moderate	Moderate	Moderate	Moderate
Road safety engineering and audit			Moderate	Moderate	Moderate	Moderate
Relevant acts, regulations and guidelines published by the government			Moderate	Moderate	Moderate	Moderate
Contract management and administration	Moderate	Moderate	Moderate	Moderate	Moderate	Moderate
Latest practices and technologies related to design, construction, maintenance & materials used in highways	High	High	High	High	High	High

Level of intervention as per competency need assessed

High	Moderate	Low
------	----------	-----

The behavioural and functional competencies mapped for the section are the follows:

Type	Competencies	ADG	CE	Director	SE	EE	AEE
Functional	Central Portals (e-office, NIC Portal, Grievance Portal, VIP Portal, Bhoomirashi Portal and any other relevant portal)						
	MS Office (Word, PowerPoint, Excel)						
	Government documentation (noting, drafting, cabinet notes, parliamentary answers, reports, Memorandum of Understanding etc.), reporting for parliamentary procedures, questions, and RTI queries						
	Financial procedures/ GFR/ Bill clearances/ PFMS						
	GRM (Grievance Redressal Mechanism), CPGRAMs and INGRAMs Portals						
	Government procurement protocols, processes, and tools (RFP, Tender Evaluation, Tender Award, Government e Marketplace - GeM) etc.)						
Behavioural	Verbal communication; Liaisoning and Negotiation skills						
	Multitasking and time management						
	Administrative and managerial skills						
	Stakeholder and people management						
	Gender sensitization and anti-sexual harassment						
	Organizational skills (such as planning, delegation, knowledge of key responsibility areas, goal setting, team building etc.)						
	Health and well-being, and stress management						
	Adaptation to new skills and methodologies						

Level of intervention as per competency need assessed

High	Moderate	Low
------	----------	-----

Training Need Assessment:

Type	Competency	Training Need Assessment
Domain	Highway Design, Construction and Maintenance	<ul style="list-style-type: none"> Advanced level training to SE & below
	Data Analysis and processing	<ul style="list-style-type: none"> Advanced level training to Director & below
	Road safety engineering and audit	<ul style="list-style-type: none"> RSA training for all technical officer below SE level
	Relevant acts, regulations and guidelines published by the government	<ul style="list-style-type: none"> Induction material to be provided to all staff
	Contract management and administration	<ul style="list-style-type: none"> Advanced training to all technical officers. Regular workshops may be conducted as well.

	Latest practices and technologies related to design, construction, maintenance & materials used in highways	<ul style="list-style-type: none"> Advanced training to all officers
Functional	Central Portals (e-office, NIC Portal, Grievance Portal, VIP Portal, Bhoomirashi Portal and any other relevant portal)	<ul style="list-style-type: none"> Trainings on portals should be provided as part of induction/ refresher trainings to increase functional efficiency of the staff members. (CE & below)
	MS Office (Word, PowerPoint, Excel)	<ul style="list-style-type: none"> Trainings on MS office should be provided for better documentation, report writing, data management etc. Advanced training to EE and below.
	Government documentation (noting, drafting, cabinet notes, parliamentary answers, reports, Memorandum of Understanding etc.), reporting for parliamentary procedures, questions, and RTI queries	<ul style="list-style-type: none"> Trainings on Government documentation, protocols, processes, etc. should be provided to all staff members.
	Financial procedures/ GFR/ Bill clearances/ PFMS	<ul style="list-style-type: none"> Basic knowledge of GFR/ Financial bills and operation of PFMS portal should be provided to all new joiners and other officers in position.
	GRM (Grievance Redressal Mechanism), CPGRAMs and INGRAMs Portals	<ul style="list-style-type: none"> Trainings on portals should be provided as part of induction/ refresher trainings to increase functional efficiency of the staff members.
	Government procurement protocols, processes, and tools (RFP, Tender Evaluation, Tender Award, Government e Marketplace - GeM) etc.)	<ul style="list-style-type: none"> Trainings on Government documentation, protocols, processes, understanding of tender, GeM portals etc. should be provided to all staff members. Trainings to be provided to all officers in positions and refresher/ induction trainings to be conducted for new joiners
Behavioural	Verbal communication; Liaisoning and Negotiation skills	<ul style="list-style-type: none"> Communication trainings should be provided to all officer up to CE level.
	Multitasking and time management	<ul style="list-style-type: none"> Trainings on multitasking and time management to be conducted for all officials to maintain healthy work life balance. Advanced training for senior officers. (Director & above)
	Administrative and managerial skills	<ul style="list-style-type: none"> Senior officials such as Director and above should be provided with advanced level trainings to upskill. Basic training to all other officers.
	Stakeholder and people management	<ul style="list-style-type: none"> Senior officials such as Director and above should be provided with advanced level trainings to upskill. Basic training to all other officers
	Gender sensitization and anti-sexual harassment	<ul style="list-style-type: none"> Such interpersonal trainings should be conducted at regular intervals and these trainings should be mandatory for all designations.
	Organizational skills (such as planning, delegation, knowledge of key responsibility areas, goal setting, team building etc.)	<ul style="list-style-type: none"> Regular upskilling required to enhance organizational skills for all employees (particularly senior officers) to delegate matters effectively. Advanced training to SE & below
	Health and well-being, and stress management	<ul style="list-style-type: none"> Trainings on balancing health to be provided to officers of all level.
	Adaptation to new skills and methodologies	<ul style="list-style-type: none"> Regular upskilling is essential to pace up with the existing technological advancements and hence trainings should be provided to all officials to increase adaptability to new technologies and their operating procedures.

d) Monitoring Section

Key focus areas

- Monitoring of projects
- Report on Award & Construction process
- Intervention areas
- Bottleneck issues assessments
- Reviewing of projects
- Cost reduction
- Expedite growth of NH and SH

Role of Monitoring Section

- General references relating to State Roads, Advisory Committees, Meeting, Nomination to Central Teams, Tools and Legislation.
- Misc. reference relating to National Capital Region, National Commission on Urbanisation, Flood Control problems affecting Roads & Bridges.
- Collection and compilation of material for Annual Report of the Ministry in respect of Roads Wing.
- Secretary PWD/Chief Engineers Meeting, Zonal Council Meetings–Reference relating thereto.
- Matters relating Parliamentary Consultative Committee meeting.
- Policy matter relating to CRF and roads of Economic & Inter State Importance.
- Compilation and submission of various returns relating to programme implementation etc.
- Coordination work except for NHAI/Audit/CAG paras.
- Coordination of Parliamentary matters in respect of Roads Wing.
- All Parliament Questions (including assurances) and VIP references received on the subjects dealt with by P&M Section.
- Conveying “NOC” to various State Governments’ Ministers/Officers visit for abroad.
- Work relating to National highways Tribunals.
- Work relating to review and monitoring of Land Acquisition, Environment, Forest, Wildlife clearances matters/Policy issues, Review & Monitoring of national Highways Projects.

Roles and functions of various officer levels:

Designation	Role and functions
ADG	<ul style="list-style-type: none"> ○ Oversee the execution of national highways projects and ensure compliance with environmental, forest, wildlife clearances, and land acquisition policies. ○ Coordinate activities related to the Monitoring Section, excluding NHAI/Audit/CAG paras. ○ Supervise the collection and compilation of material for the Annual Report of the Ministry in relation to the Roads Wing. ○ Manage and coordinate parliamentary matters specific to the Roads Wing. ○ Oversee work related to National Highways Tribunals and represent the Ministry at international forums if required.
EE	<ul style="list-style-type: none"> ○ Monitor the progress of national highways projects and ensure they adhere to the prescribed policies for land acquisition, environment, forest, and wildlife clearances.

Figure 11: Organogram - Monitoring Section

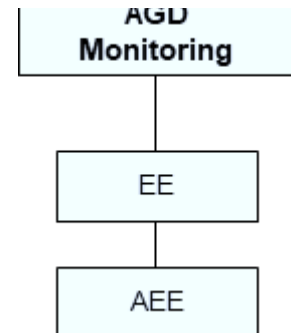

Designation	Role and functions
	<ul style="list-style-type: none"> Review and address policy issues related to the execution of national highways projects. Compile and submit various returns related to program implementation, ensuring accuracy and completeness. Manage the collection of materials for the Annual Report of the Ministry concerning the Roads Wing. Handle parliamentary matters in respect of the Roads Wing, including the preparation of responses to Parliament Questions and VIP references.
AEE	<ul style="list-style-type: none"> Provide administrative support for various meetings, including the preparation of documents, minutes, and follow-up actions. Handle miscellaneous references related to the National Capital Region, National Commission on Urbanisation, and other relevant topics. Assist in the compilation of materials for the Annual Report of the Ministry regarding the Roads Wing. Coordinate activities related to the Monitoring Section, excluding NHAI/Audit/CAG paras. Support in the preparation of responses to all Parliament Questions (including assurances) and VIP references received on subjects dealt with by the P&M Section.

Based on the roles and functions, the domain competencies identified across various officer levels are:

Domain Competencies	ADG	EE	AEE
Highway Design, Construction and Maintenance			
Data Analysis and processing			
Road safety engineering and audit			
Project Management, controlling and reporting including various project management tools and techniques.			
Contract management and administration			
Latest practices and technologies related to design, construction, maintenance & materials used in highways			

Level of intervention as per competency need assessed

High	Moderate	Low
------	----------	-----

The behavioural and functional competencies mapped for the section are the follows:

Type	Competencies	ADG	EE	AEE
Functional	Central Portals (e-office, NIC Portal, Grievance Portal, VIP Portal, Bhoomirashi Portal and any other relevant portal)			
	MS Office (Word, PowerPoint, Excel)			
	Government documentation (noting, drafting, cabinet notes, parliamentary answers, reports, Memorandum of Understanding etc.), reporting for parliamentary procedures.			

Type	Competencies	ADG	EE	AEE
	questions, and RTI queries			
	Financial procedures/ GFR/ Bill clearances/ PFMS			
	GRM (Grievance Redressal Mechanism), CPGRAMs and INGRAMs Portals			
	Government procurement protocols, processes, and tools (RFP, Tender Evaluation, Tender Award, Government e Marketplace – GeM) etc.)			
Behavioural	Verbal communication; Liaisoning and Negotiation skills			
	Multitasking and time management			
	Administrative and managerial skills			
	Stakeholder and people management			
	Gender sensitization and anti-sexual harassment			
	Organizational skills (such as planning, delegation, knowledge of key responsibility areas, goal setting, team building etc.)			
	Health and well-being, and stress management			
	Adaptation to new skills and methodologies			

Level of intervention as per competency need assessed

High	Moderate	Low
------	----------	-----

Training Need Assessment:

Type	Competency	Training Need Assessment
Domain	Highway Design, Construction and Maintenance	<ul style="list-style-type: none"> Advanced level training to SE & below
	Data Analysis and processing	<ul style="list-style-type: none"> Advanced level training to Director & below
	Road safety engineering and audit	<ul style="list-style-type: none"> RSA training for all technical officer below EE level
	Project Management, controlling and reporting including various project management tools and techniques.	<ul style="list-style-type: none"> Advanced project management training for EE & below
	Contract management and administration	<ul style="list-style-type: none"> Advanced training to all technical officers. Regular workshops may be conducted as well.
	Latest practices and technologies related to design, construction, maintenance & materials used in highways	<ul style="list-style-type: none"> Advanced training to all officers
Functional	Central Portals (e-office, NIC Portal, Grievance Portal, VIP Portal, Bhoomirashi Portal and any other relevant portal)	<ul style="list-style-type: none"> Trainings on portals should be provided as part of induction/ refresher trainings to increase functional efficiency of the staff members.
	MS Office Skills (Word, PowerPoint, Excel)	<ul style="list-style-type: none"> Advanced training to EE and below. Refresher/ induction training should be provided for all new joiners.
	Government documentation (noting, drafting, cabinet notes, parliamentary answers, reports, Memorandum of Understanding etc.), reporting for parliamentary procedures, questions, and	<ul style="list-style-type: none"> Trainings on Government documentation, protocols, processes, etc. should be provided to all staff members.

	RTI queries	
	Financial procedures/ GFR/ Bill clearances/ PFMS	<ul style="list-style-type: none"> Basic knowledge of GFR/ Financial bills and operation of PFMS portal should be provided to all new joiners and other officers in position.
	GRM (Grievance Redressal Mechanism), CPGRAMs and INGRAMs Portals	<ul style="list-style-type: none"> Trainings on portals should be provided as part of induction/ refresher trainings to increase functional efficiency of the staff members.(EE& below)
	Government procurement protocols, processes, and tools (RFP, Tender Evaluation, Tender Award, Government e Marketplace - GeM) etc.)	<ul style="list-style-type: none"> Trainings on Government documentation, protocols, processes, understanding of tender, GeM portals etc. should be provided to EE & below. .
Behavioural	Verbal communication; Liaisoning and Negotiation skills	<ul style="list-style-type: none"> Communication trainings should be provided to all officer.
	Multitasking and time management	<ul style="list-style-type: none"> Advanced training for all officers.
	Administrative and managerial skills	<ul style="list-style-type: none"> Advanced training for all officers
	Stakeholder and people management	<ul style="list-style-type: none"> Advanced training for all officers.
	Gender sensitization and anti-sexual harassment	<ul style="list-style-type: none"> Such interpersonal trainings should be conducted at regular intervals and these trainings should be mandatory for all designations.
	Organizational skills (such as planning, delegation, knowledge of key responsibility areas, goal setting, team building etc.)	<ul style="list-style-type: none"> Regular upskilling required to enhance organizational skills for all employees (particularly ADG & EE) to delegate matters effectively.
	Health and well-being, and stress management	<ul style="list-style-type: none"> Trainings on balancing health to be provided to officers of all level.
	Adaptation to new skills and methodologies	<ul style="list-style-type: none"> Regular upskilling is essential to pace up with the existing technological advancements and hence trainings should be provided to all officials to increase adaptability to new technologies and their operating procedures.

e) Externally Aided Projects (EAP) Zone

Externally aided project section is under Road Wing. It handles matters related to monitoring and execution of work with Multilateral agencies for project linked with external aids.

Figure 12: Organogram - EAP Zone

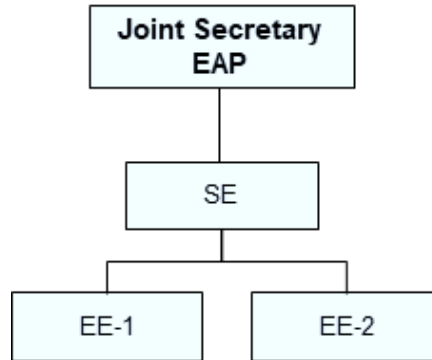

Key focus areas

- External funded project dealings
- Monitoring and development work

Role of EAP Zone

- Monitoring all construction matters relating to EAP projects taken by the Central Ministry, amendment of contract documents for civil work contracts, Authority Engineering, DPR Consultant, Monitoring the development of "e-Disha" which is an Enterprise Resource Planning (ERP Project) followed by Electronic Road Accident Database (e-DAR), updating of work for all road and bridge works to the database
- Individual EAPs are headed by a Chief/ Superintending Engineer with sectional supports.
- Currently Green National Highways Corridor Project (GNHCP) and Electronic Road Accident Database (e-DAR) are the ongoing EAP in MoRTH.

Roles and functions of various officer levels:

Designation	Role and functions
JS	<ul style="list-style-type: none"> ○ Provide strategic oversight for the Green National Highways Corridor Project (GNHCP) and Electronic Road Accident Database (e-DAR), ensuring these projects are executed in accordance with established guidelines. ○ Supervise the amendment of contract documents for civil work contracts, Authority Engineering, and other contractual matters related to EAP projects. ○ Monitor the development of "e-Disha," an Enterprise Resource Planning (ERP) Project, and Electronic Road Accident Database (e-DAR), ensuring effective implementation and integration of technology for streamlined project management
SE	<ul style="list-style-type: none"> ○ Lead individual EAPs, providing technical and managerial guidance to ensure the successful execution of projects under their purview. ○ Manage and coordinate sectional supports within individual EAPs, ensuring effective collaboration and communication among different units for seamless project implementation. ○ Liaison with respective funding agency (World Bank, ADB etc.) on relevant matters ○ Oversee the amendment of contract documents for civil work contracts, ensuring compliance with regulations and standards. Manage the contractual aspects of EAP projects.
EE	<ul style="list-style-type: none"> ○ Monitor all construction matters related to EAP projects undertaken by the Ministry, conducting regular evaluations to ensure projects are on track and meet quality standards ○ Oversee the development and maintenance of the Electronic Road Accident Database (e-DAR), ensuring accurate and up-to-date information is captured for effective road safety analysis. ○ Contribute to the development of the "e-Disha" ERP Project, actively participating in its

Designation	Role and functions
	implementation and ensuring that it aligns with the objectives of the EAP Section.

Based on the roles and functions, the domain competencies identified across various officer levels are:

Domain Competencies	JS	SE	EE
Highway Design, Construction and Maintenance			
Data Analysis and processing			
Project Management, controlling and reporting including various project management tools and techniques.			
Contract management and administration			
Latest practices and technologies related to design, construction, maintenance & materials used in highways			

Level of intervention as per competency need assessed

High	Moderate	Low
------	----------	-----

The behavioural and functional competencies mapped for the section are the follows:

Type	Competencies	JS	SE	EE
Functional	Central Portals (e-office, NIC Portal, Grievance Portal, VIP Portal, Bhoomirashi Portal and any other relevant portal)			
	MS Office (Word, PowerPoint, Excel)			
	Government documentation (noting, drafting, cabinet notes, parliamentary answers, reports, Memorandum of Understanding etc.), reporting for parliamentary procedures, questions, and RTI queries			
	Financial procedures/ GFR/ Bill clearances/ PFMS			
	GRM (Grievance Redressal Mechanism), CPGRAMs and INGRAMs Portals			
	Government procurement protocols, processes, and tools (RFP, Tender Evaluation, Tender Award, Government e Marketplace - GeM) etc.)			
Behavioural	Verbal communication; Liaisoning and Negotiation skills			
	Multitasking and time management			
	Administrative and managerial skills			
	Stakeholder and people management			
	Gender sensitization and anti-sexual harassment			
	Organizational skills (such as planning, delegation, knowledge of			

Type	Competencies	JS	SE	EE
	key responsibility areas, goal setting, team building etc.)			
	Health and well-being, and stress management			
	Adaptation to new skills and methodologies			

Level of intervention as per competency need assessed

High	Moderate	Low
------	----------	-----

Training Need Assessment:

Type	Competency	Training Need Assessment
Domain	Highway Design, Construction and Maintenance	<ul style="list-style-type: none"> Basic training to SE & below
	Data Analysis and processing	<ul style="list-style-type: none"> Advanced training for SE & below
	Project Management, controlling and reporting including various project management tools and techniques.	<ul style="list-style-type: none"> Basic training for JS. Advanced training required for SE & below
	Contract management and administration	<ul style="list-style-type: none"> Advanced training for all staff
	Latest practices and technologies related to design, construction, maintenance & materials used in highways	<ul style="list-style-type: none"> Advanced training for all staff
Functional	Central Portals (e-office, NIC Portal, Grievance Portal, VIP Portal, Bhoomirashi Portal and any other relevant portal)	<ul style="list-style-type: none"> Trainings on portals should be provided as part of induction/ refresher trainings to increase functional efficiency of the staff members.
	MS Office Skills (Word, PowerPoint, Excel)	<ul style="list-style-type: none"> Trainings on MS office should be provided for better documentation, report writing, data management etc. Advanced training to EEs
	Government documentation (noting, drafting, cabinet notes, parliamentary answers, reports, Memorandum of Understanding etc.), reporting for parliamentary procedures, questions, and RTI queries	<ul style="list-style-type: none"> Trainings on Government documentation, protocols, processes, etc. should be provided to all staff members. Trainings to be provided to all officers in positions and refresher/ induction trainings to be conducted for new joiners.
	Financial procedures/ GFR/ Bill clearances/ PFMS	<ul style="list-style-type: none"> Basic knowledge of GFR/ Financial bills and operation of PFMS portal should be provided to all new joiners and other officers in position.
	GRM (Grievance Redressal Mechanism), CPGRAMs and INGRAMs Portals	<ul style="list-style-type: none"> Trainings on portals should be provided as part of induction/ refresher trainings to increase functional efficiency of the staff members.
	Government procurement protocols, processes, and tools (RFP, Tender Evaluation, Tender Award, Government e Marketplace - GeM) etc.)	<ul style="list-style-type: none"> Trainings on Government documentation, protocols, processes, understanding of tender, GeM portals etc. should be provided to all staff members.
Behavioural	Verbal communication; Liaisoning and Negotiation skills	<ul style="list-style-type: none"> Communication trainings should be provided to all officer up to SE level.
	Multitasking and time management	<ul style="list-style-type: none"> Trainings on multitasking and time management to be conducted for all officials to maintain healthy work life balance. Advanced training for all officers

	Administrative and managerial skills	<ul style="list-style-type: none"> Advanced training for all officers.
	Stakeholder and people management	<ul style="list-style-type: none"> Advanced training for all officers.
	Gender sensitization and anti-sexual harassment	<ul style="list-style-type: none"> Such interpersonal trainings should be conducted at regular intervals and these trainings should be mandatory for all designations.
	Organizational skills (such as planning, delegation, knowledge of key responsibility areas, goal setting, team building etc.)	<ul style="list-style-type: none"> Regular upskilling required to enhance organizational skills for all employees (particularly senior officers) to delegate matters effectively.
	Health and well-being, and stress management	<ul style="list-style-type: none"> Trainings on balancing health to be provided to officers of all level.
	Adaptation to new skills and methodologies	<ul style="list-style-type: none"> Regular upskilling is essential to pace up with the existing technological advancements and hence trainings should be provided to all officials to increase adaptability to new technologies and their operating procedures.

2.6.2.2. Road Transport Wing

The Road Transport Wing of MoRTH, is mainly focused on the formulation of broad policies relating to regulation of road transport in the country, working on automotive norms making it easy for movement of vehicular traffic with neighboring countries by establishing certain arrangements. The figure below shows the structure of the Road Transport Wing. It has three divisions –

- Motor Vehicle Legislation & Automotive Division
- Road Safety Division
- Transport Division

a) Motor Vehicle Legislation & Automotive Division

Figure 13: Organogram - MVL & Automotive Division

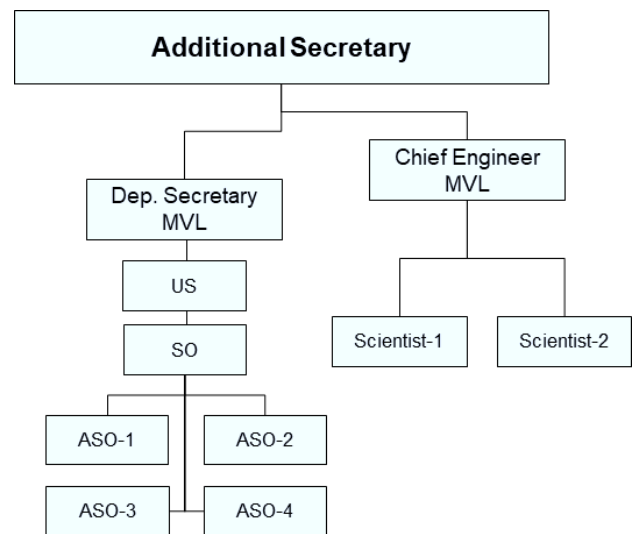

Key focus areas

- Motor Vehicles Legislation (including Motor Vehicle Act, Central Motor Vehicle Rules and Motor Vehicle Regulations) along with subsequent Amendments, Clarifications, and Examinations
- Automotive norms

Role of MVL & Automotive Division

- Motor Vehicle Legislation (MVL) – This division focuses on the Motor Vehicle Act, Central Motor Vehicle Rules and Motor Vehicle Regulation
- It also helps in issuing smart cards/ driving licenses/ and amendments if any.
- Conduct meeting on central Motor Vehicles Rules-Technical Standing Committee (CMVR- TCS) and Standing Committee on Emission (SCOE) and follow up action
- Miscellaneous works related to Central Motor Vehicle Rules (CMVRs)
 - Insurance related matter and high security issues
 - Use of red light, speed governors, Auto fuel Policy, RTI, Public grievances, and other court related issues
 - Handles matters related to Transport Development Council (TDC)
 - Tire uses.
 - Amendments in CMVRs
 - Code of Practice for bus body design
 - Cess Funds
 - Handling all reports and returns matters.
 - Transportation of Dangerous and Hazardous goods

Roles and functions of various officer levels:

Designation	Role and functions
AS	<ul style="list-style-type: none"> ○ Managing all the work under the transport wing ○ Assigning tasks / work allocation for junior workforce ○ Working on areas of amendment in Acts and Rules ○ Approving the schemes / policies in accordance with the provisions of MV Act 1988 and CMVR 1989 ○ Budget matters related to MVL wing ○ Overseeing reply to parliamentary questions

Designation	Role and functions
CE (MVL)	<ul style="list-style-type: none"> Managing all automotive related activities in the Section Coordinate with relevant stakeholders at central & state level for automotive rules/ norms. Coordinate with external agencies like CIRT, ARAI, ICAT for implementation of identified initiatives Development of policies related to new technologies such as EV, alternate fuels etc.
DS	<ul style="list-style-type: none"> Ensure compliance with Central Motor Vehicle Rules (CMVRs), focusing on areas such as insurance-related matters, traffic violations, etc. Provide support for meetings of CMVR-TCS and SCOE, including the organization of meetings, preparation of documents, and follow-up actions. Handle miscellaneous works related to CMVRs, such as issues pertaining to RTI, public grievances, and court-related matters. Manage and handle all reports and returns matters, ensuring accurate and timely submissions in compliance with regulations.
US	<ul style="list-style-type: none"> Coordinate and facilitate the process of amendments in CMVRs, ensuring proper documentation and communication. Assist in the implementation and enforcement of legislative changes. Provide support in handling court cases, public grievances and RTI matters.
Scientist	<ul style="list-style-type: none"> Support CE in conducting analysis and research for identified initiatives related to vehicle technologies, EV, alternate fuels etc. Analysis of vehicular related data such as age, type, performance etc. Coordinating with relevant stakeholders for data collection and consultations
SO/ ASO	<ul style="list-style-type: none"> Maintain comprehensive documentation and records related to Motor Vehicle Legislation, including amendments, reports, and returns. Assist in the organization and documentation of meetings, ensuring accurate and accessible records. Coordinate miscellaneous works related to CMVRs, such as issues related to the use of road transport, road safety and other legislative matters.

Based on the roles and functions, the domain competencies identified across various officer levels are:

Domain Competencies	AS	CE	DS	US	Scientist	SO/ ASO
Matters related to Motor Vehicles Act, 1988						
Matters related to Central Motor Vehicles Rules, 1989						
Automotive norms plans and policies implementation, Automotive Industry Standards (AIS-001, 002 etc.)						
Automotive Testing standards and safety						
Handling of Court Matters related and cases						
Legislative drafting						
e Emission guidelines, initiatives and policies related to emission reduction including alternate fuels etc.						
Global practices and innovation in automotive regulations, safety norms, testing norms etc.						

Level of intervention as per competency need assessed

High	Moderate	Low
------	----------	-----

The behavioural and functional competencies mapped for the section are the follows:

Type	Competencies	AS	CE	DS	US	Scientist	SO/ ASO
Functional	Central Portals (e-office, NIC Portal, Grievance Portal, VIP Portal, Bhoomirashi Portal and any other relevant portal)	Low	Low	Low	Low	High	High
	MS Office (Word, PowerPoint, Excel)	High	High	High	High	High	High
	Government documentation (noting, drafting, cabinet notes, parliamentary answers, reports, Memorandum of Understanding etc.), reporting for parliamentary procedures, questions, and RTI queries	Low	Low	Low	Low	High	High
	Financial procedures/ GFR/ Bill clearances/ PFMS	High	High	High	High	Low	High
	GRM (Grievance Redressal Mechanism), CPGRAMs and INGRAMs Portals	High	High	High	High	High	High
	Government procurement protocols, processes, and tools (RFP, Tender Evaluation, Tender Award, Government e Marketplace - GeM) etc.)	High	High	High	High	High	High
	Judicial Pronouncement and Restrictions, Audit Paras and Court Cases	High	High	High	High	High	High
Behavioural	Verbal communication; Liaisoning and Negotiation skills	Low	Low	Low	High	High	High
	Multitasking and time management	High	High	High	High	Low	Low
	Administrative and managerial skills	High	High	High	High	Low	Low
	Stakeholder and people management	Low	Low	Low	High	Low	Low
	Gender sensitization and anti-sexual harassment	High	High	High	High	High	High
	Organizational skills (such as planning, delegation, knowledge of key responsibility areas, goal setting, team building etc.)	Low	Low	Low	High	High	High
	Health and well-being, and stress management	High	High	High	High	High	High
	Adaptation to new skills and methodologies	High	High	High	High	High	High

Level of intervention as per competency need assessed

High	Moderate	Low
------	----------	-----

Training Need Assessment:

Type	Competency	Training Need Assessment
Do mai n	Matters related to Motor Vehicles Act, 1988	<ul style="list-style-type: none"> Induction material to be provided to all staff Regular training/ workshops related to implemented

		amendments to all staff (DS & below)
	Matters related to Central Motor Vehicles Rules, 1989	<ul style="list-style-type: none"> • Induction material to be provided to all staff • Regular training/ workshops related to implemented amendments to all staff (DS & below)
	Automotive norms plans and policies implementation, Automotive Industry Standards (AIS-001, 002 etc.)	<ul style="list-style-type: none"> • Advanced training for Scientists • Refresher training for CE
	Automotive Testing standards and safety	<ul style="list-style-type: none"> • Advanced training for Scientists • Refresher training for CE
	Handling of Court Matters related and cases	<ul style="list-style-type: none"> • Advanced training for all Administrative officers
	Legislative drafting	<ul style="list-style-type: none"> • Advanced training for all DS & below
	e Emission guidelines, initiatives and policies related to emission reduction including alternate fuels etc.	<ul style="list-style-type: none"> • Advanced training for Scientists • Refresher training for CE
	Global practices and innovation in automotive regulations, safety norms, testing norms etc.	<ul style="list-style-type: none"> • Advanced training for Scientists • Refresher training for CE
Functional	Central Portals (e-office, NIC Portal, Grievance Portal, VIP Portal, Bhoomirashi Portal and any other relevant portal)	<ul style="list-style-type: none"> • Trainings on portals should be provided as part of induction/ refresher trainings to increase functional efficiency of the staff members.
	MS Office Skills (Word, PowerPoint, Excel)	<ul style="list-style-type: none"> • Trainings on MS office should be provided for better documentation, report writing, data management etc. • Advanced training to US and below.
	Government documentation (noting, drafting, cabinet notes, parliamentary answers, reports, Memorandum of Understanding etc.), reporting for parliamentary procedures, questions, and RTI queries	<ul style="list-style-type: none"> • Trainings on Government documentation, protocols, processes, etc. should be provided to all staff members.
	Financial procedures/ GFR/ Bill clearances/ PFMS	<ul style="list-style-type: none"> • Basic knowledge of GFR/ Financial bills and operation of PFMS portal should be provided to all new joiners and other officers in position.
	GRM (Grievance Redressal Mechanism), CPGRAMs and INGRAMs Portals	<ul style="list-style-type: none"> • Trainings on portals should be provided as part of induction/ refresher trainings to increase functional efficiency of the staff members.
	Government procurement protocols, processes, and tools (RFP, Tender Evaluation, Tender Award, Government e Marketplace - GeM) etc.)	<ul style="list-style-type: none"> • Trainings to be provided to all officers in positions and refresher/ induction trainings to be conducted for new joiners.
	Judicial Pronouncement and Restrictions, Audit Paras and Court Cases	<ul style="list-style-type: none"> • Basic trainings to handle matters related to court and other PMO related Q&A should be provided to all officers. • Trainings should be made mandatory for all officers
Behavioural	Verbal communication; Liaisoning and Negotiation skills	<ul style="list-style-type: none"> • Communication trainings should be provided to all officer up to CE level.
	Multitasking and time management	<ul style="list-style-type: none"> • Advanced training - US and above
	Administrative and managerial skills	<ul style="list-style-type: none"> • Advanced training - US and above
	Stakeholder and people management	<ul style="list-style-type: none"> • Advanced training - US and above
	Gender sensitization and anti-sexual harassment	<ul style="list-style-type: none"> • Such interpersonal trainings should be conducted at regular intervals and these trainings should be mandatory for all designations.
	Organizational skills (such as planning, delegation, knowledge of key	<ul style="list-style-type: none"> • Regular upskilling required to enhance organizational skills for

responsibility areas, goal setting, team building etc.)	all employees (particularly senior officers) to delegate matters effectively,
Health and well-being, and stress management	<ul style="list-style-type: none"> • Trainings on balancing health to be provided to officers of all level.
Adaptation to new skills and methodologies	<ul style="list-style-type: none"> • Regular upskilling is essential to pace up with the existing technological advancements and hence trainings should be provided to all officials to increase adaptability to new technologies and their operating procedures.

b) Road Safety Division

Road Safety Division plays a crucial role in planning policies and schemes to ensure safe on road driving for motorists and to reduce road fatalities.

Figure 14: Organogram - Road Safety Division

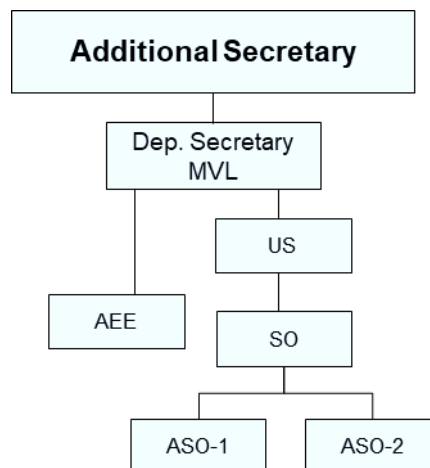

Key focus areas

- Road safety plans,
- Policies and schemes and
- Setting framework for mitigation measures

Role of Road Safety Division

- Road Safety Division deals in spreading awareness and education about road safety measures and is working on various schemes, programs and events related to road safety.
- It deals in providing information to various agencies regarding matters related to road safety.
- Observance of road safety week to spread awareness and conduct seminars and workshops.
- Providing necessary grants to voluntary organizations for schemes related to road safety.
- Assisting in setting up for inspection and certificate center and driving training institutes
- Publicity measures and public awareness and Road Safety Education.
- National Road Safety Council.
- National Highways Patrolling Scheme/ National Highways Accident Relief Service Scheme.
- Supply of information to the various agencies regarding Road Safety.

- Collection of road accident data from State Govts/UT, Administrations, Metropolitan cities, SRTUs, DTC authorities.
- Grant-in-Aid to State Govts. and voluntary Organizations for schemes relating to Road Safety.
- Scheme for Strengthening Drivers/instructors Procurement and training institutes.
- Road Safety Equipments-Procurement and allotment to various State Govts/agencies in field for Road Safety.
- Training of Drivers in Un-Organized Sector.]

Roles and functions of various officer levels:

Designation	Role and functions
AS	<ul style="list-style-type: none"> ○ Provide strategic guidance on initiatives aimed at improving road safety, spreading awareness and education about road safety. ○ Manage the allocation and distribution of necessary grants to voluntary organizations for schemes related to road safety, ensuring transparency and compliance with regulations. ○ Attend international conferences/ meetings related to road safety ○ Oversee preparation of various road safety policies and initiatives in the Ministry
DS	<ul style="list-style-type: none"> ○ Coordinate and implement awareness programs, events, and schemes related to road safety, working towards reducing road accidents and promoting safe practices. ○ Support the Road Safety Division in conducting seminars, workshops, and other events. ○ Oversee the functioning of the National Road Safety Council, coordinating its activities and initiatives. ○ Ensure the supply of information to various agencies regarding road safety, fostering a collaborative approach to address safety concerns. ○ Support in the collection of road accident data from State Governments/UTs, Administrations, Metropolitan cities, SRTUs, and DTC authorities.
US	<ul style="list-style-type: none"> ○ Administer grants-in-aid to State Governments and voluntary organizations for schemes related to road safety, ensuring proper utilization and compliance with guidelines. ○ Addressing comments on various cabinet note, PM infra, e-Samiksha, metro projects, etc. ○ Manage award of works and financial disbursement of Road Safety Advocacy scheme
AEE	<ul style="list-style-type: none"> ○ Provide technical and administrative support to DS on road safety engineering matters ○ Conduct data analysis with respect to road accidents and fatalities and provide insights to DS and AS ○ Coordinate with relevant stakeholders for consultations and data collection ○ Support DS in preparation of various schemes and policies related to road safety
SO/ ASO	<ul style="list-style-type: none"> ○ Facilitate the collection of road accident data from State Governments/UTs, Administrations, Metropolitan cities, SRTUs, and DTC authorities, ensuring accuracy and timely reporting. ○ Assist in the compilation and analysis of road safety data for informed decision-making. ○ Provide administrative support for the various initiatives and schemes related to road safety, including the management of documentation, records, and correspondence. ○ Support in the implementation of schemes focused on strengthening drivers and instructors in procurement and training institutes.

Based on the roles and functions, the domain competencies identified across various officer levels are:

Domain Competencies	AS	DS	US	AEE	SO/ ASO
Road safety related Act, rules and regulations					
Road Safety Audit and Blackspot rectification					
Road Safety Awareness programs					
Preparation of schemes related to road safety					

Domain Competencies	AS	DS	US	AEE	SO/ ASO
Data analysis and compilation					

Level of intervention as per competency need assessed

High	Moderate	Low
------	----------	-----

The behavioural and functional competencies mapped for the section are the follows:

Type	Competencies	AS	CE	DS	US	AEE	SO/ ASO
Functional	Central Portals (e-office, NIC Portal, Grievance Portal, VIP Portal, Bhoomirashi Portal and any other relevant portal)						
	MS Office (Word, PowerPoint, Excel)						
	Government documentation (noting, drafting, cabinet notes, parliamentary answers, reports, Memorandum of Understanding etc.), reporting for parliamentary procedures, questions, and RTI queries						
	Financial procedures/ GFR/ Bill clearances/ PFMS						
	GRM (Grievance Redressal Mechanism), CPGRAMs and INGRAMs Portals						
	Government procurement protocols, processes, and tools (RFP, Tender Evaluation, Tender Award, Government e Marketplace - GeM) etc.)						
	Judicial Pronouncement and Restrictions, Audit Paras and Court Cases						
Behavioural	Verbal communication; Liaisoning and Negotiation skills						
	Multitasking and time management						
	Administrative and managerial skills						
	Stakeholder and people management						
	Gender sensitization and anti-sexual harassment						
	Organizational skills (such as planning, delegation, knowledge of key responsibility areas, goal setting, team building etc.)						
	Health and well-being, and stress management						
	Adaptation to new skills and methodologies						

Level of intervention as per competency need assessed

High	Moderate	Low
------	----------	-----

Training Need Assessment:

Type	Competency	Training Need Assessment
Domain	Road safety related Act, rules and regulations	<ul style="list-style-type: none"> • Induction material to be provided to all staff • Workshop/ training required for Officers (US & below)
	Road Safety Audit and Blackspot rectification	<ul style="list-style-type: none"> • Technical training for technical officers
	Road Safety Awareness programs	<ul style="list-style-type: none"> • Training/ workshop for officers (US & below)
	Preparation of schemes related to road safety	<ul style="list-style-type: none"> • Training/ workshop for officers (US & below)
	Data analysis and compilation	<ul style="list-style-type: none"> • Advanced training for AEE, SO and ASOs
Functional	Central Portals (e-office, NIC Portal, Grievance Portal, VIP Portal, Bhoomirashi Portal and any other relevant portal)	<ul style="list-style-type: none"> • Trainings on portals should be provided as part of induction/ refresher trainings to increase functional efficiency of the staff members.
	MS Office Skills (Word, PowerPoint, Excel)	<ul style="list-style-type: none"> • Trainings on MS office should be provided for better documentation, report writing, data management etc. • Advanced training to US and below. • Refresher/ induction training should be provided for all new joiners.
	Government documentation (noting, drafting, cabinet notes, parliamentary answers, reports, Memorandum of Understanding etc.), reporting for parliamentary procedures, questions, and RTI queries	<ul style="list-style-type: none"> • Trainings on Government documentation, protocols, processes, etc. should be provided to all staff members. • Trainings to be provided to all officers in positions and refresher/ induction trainings to be conducted for new joiners.
	Financial procedures/ GFR/ Bill clearances/ PFMS	<ul style="list-style-type: none"> • Basic knowledge of GFR/ Financial bills and operation of PFMS portal should be provided to all new joiners and other officers in position.
	GRM (Grievance Redressal Mechanism), CPGRAMs and INGRAMs Portals	<ul style="list-style-type: none"> • Trainings on portals should be provided as part of induction/ refresher trainings to increase functional efficiency of the staff members.
	Government procurement protocols, processes, and tools (RFP, Tender Evaluation, Tender Award, Government e Marketplace - GeM) etc.)	<ul style="list-style-type: none"> • Trainings on Government documentation, protocols, processes, understanding of tender, GeM portals etc. should be provided to all staff members. • Trainings to be provided to all officers in positions and refresher/ induction trainings to be conducted for new joiners.
	Judicial Pronouncement and Restrictions, Audit Paras and Court Cases	<ul style="list-style-type: none"> • Basic trainings to handle matters related to court and other PMO related Q&A should be provided to all officers. • Trainings should be made mandatory.
Behavioural	Verbal communication; Liaisoning and Negotiation skills	<ul style="list-style-type: none"> • Effective communication plays a crucial role in handling day to day ministerial activities in both written and verbal form. It encourages effective dialogue. Negotiation, understanding on perspectives, building relationships and smooth transfer of knowledge. • Hence, communication trainings should be provided to all officer up to Director level.
	Multitasking and time management	<ul style="list-style-type: none"> • Trainings on multitasking and time management to be conducted for all officials to maintain healthy work life balance. • Advanced training for senior officers.
	Administrative and managerial skills	<ul style="list-style-type: none"> • To run an efficient team, training should be provided for enhancing the managerial skills of the section staff. It will

	increase the sense of decision making, communication, strategic planning etc. <ul style="list-style-type: none"> Senior officials such as Director and above should be provided with advanced level trainings to upskill. Induction / Refresher training to be provided for new joiners.
Stakeholder and people management	<ul style="list-style-type: none"> Trainings to handle and negotiate with stakeholders both internal and external shall be provided to the staffs for ease knowledge transfer through means of communication.
Gender sensitization and anti-sexual harassment	<ul style="list-style-type: none"> To promote inclusivity, enhance organizational culture, prevent harassment at workplace, regular trainings should be provided on sensitive topics such as sexual harassment. Such interpersonal trainings should be conducted at regular intervals and these trainings should be mandatory for all designations.
Organizational skills (such as planning, delegation, knowledge of key responsibility areas, goal setting, team building etc.)	<ul style="list-style-type: none"> Regular upskilling required to enhance organizational skills for all employees (particularly senior officers) to delegate matters effectively,
Health and well-being, and stress management	<ul style="list-style-type: none"> Importance of proper healthy wellbeing should be taught to individuals. Trainings on balancing health to be provided to officers of all level.
Adaptation to new skills and methodologies	<ul style="list-style-type: none"> Regular upskilling is essential to pace up with the existing technological advancements and hence trainings should be provided to all officials to increase adaptability to new technologies and their operating procedures.

c) Transport Division

Transport Division administers certain rules like Road Transport Corporation, 1950, Carriers Act, 1965, Carriage by Roads Act, 2007. Along with enforcing the laws, it also formulates the Budget and Annual Five-Year Plan of Road Transport Wing. Studying and researching about the Indian transport sector and takes up certain matters relating to some of the governmental organization like CIRT, Pune, Association of State Road Transport Undertakings.

Figure 15: Organogram - Transport Section

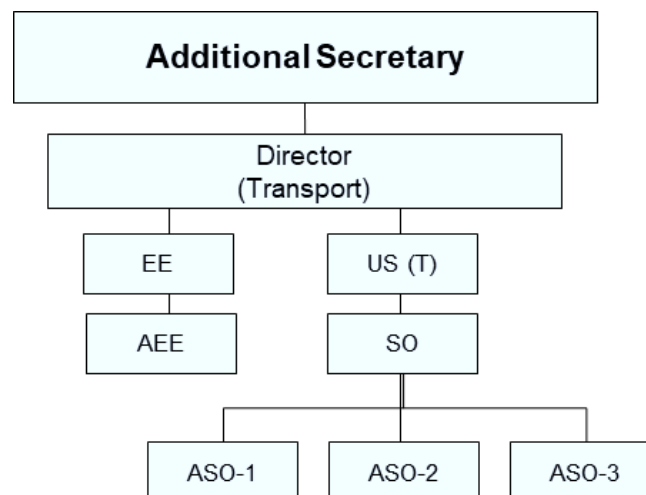

Key focus areas

- Automated Testing Stations and Scrapping Centres
- Road Transport plans and policies
- State Transport Undertaking (STU) matters

Role of Transport Section

- Budget and annual Plan Five Year Plan of Road Transport Wing.
- Transport Development Council Meeting and follow up action.
- Studies on Road Transport Sector.
- Matters relating to State Road Transport Corporations.
- Road Transport Corporation Act, 1950 and Carriers Act, 1965, Carriage by road Act, 2007.
- Court cases relating to above subjects.
- Residuary matters relating to Solatium Fund Scheme.
- Problem of transport Operators.
- Training Programmes for State Transport Department Personnel.
- Matters related to CIRT, Pune
- Training and HRD activities in the Road Transport Sector. (If the Training Programme involves participation by any officer of the Ministry, its attached/subordinate offices/PSUs/ Autonomous Bodies/Associate Offices, then the processing will be done and decisions on nominations will be taken by the Administration Wing after consultation with the RT Division).
- Transport Services run by State Govts./Union Territories/STUs and companies.

Roles and functions of various officer levels:

Designation	Role and functions
AS	<ul style="list-style-type: none"> ○ Develop and implement the budget and annual plan, aligning with the Five Year Plan of the Road Transport Wing. ○ Provide strategic guidance on matters related to the Transport Development Council Meeting and ensure follow-up actions are taken. ○ Oversee studies on the Road Transport Sector, providing insights and recommendations for policy improvement. ○ Handle matters related to State Road Transport Corporations and monitor compliance with the Road Transport Corporation Act, 1950, Carriers Act, 1965, and Carriage by Road Act, 2007. ○ Manage court cases related to the Road Transport Section, including those concerning the Road Transport Corporation Act, Carriers Act, and Carriage by Road Act.
Director	<ul style="list-style-type: none"> ○ Conduct studies and analysis on the Road Transport Sector, providing insights into trends, challenges, and opportunities. ○ Oversee matters related to State Road Transport Corporations, ensuring compliance with relevant legislative acts. ○ Implement decisions and actions following the Transport Development Council Meeting, ensuring effective coordination and communication. ○ Provide guidance on the resolution of problems faced by transport operators, facilitating a conducive environment for the sector. ○ Ensure implementation of Voluntary vehicle fleet modernization program (through ATS and RVSF)
EE/ AEE	<ul style="list-style-type: none"> ○ Contribute to the strategic planning of the Road Transport Section by providing insights into infrastructure needs and requirements. ○ Assist in the implementation of projects related to transport infrastructure. ○ Provide technical expertise in matters related to road transport, offering insights into

Designation	Role and functions
	<ul style="list-style-type: none"> engineering aspects and considerations. Collaborate with State Road Transport Corporations and other entities to address infrastructure challenges. Contribute to the development and improvement of transport services through technical insights.
US	<ul style="list-style-type: none"> Ensure compliance with the Road Transport Corporation Act, 1950, Carriers Act, 1965, and Carriage by Road Act, 2007, providing support for related legal matters. Oversee transport services run by State Governments, Union Territories, State Transport Undertakings (STUs), and companies. Maintain comprehensive documentation and records related to the budget, annual plan, and Five Year Plan of the Road Transport Wing. Support in the documentation of Transport Development Council Meetings and related follow-up actions.
SO/ ASO	<ul style="list-style-type: none"> Provide administrative support for budget planning and the annual plan of the Road Transport Wing. Assist in organizing and documenting Transport Development Council Meetings and related activities. Coordinate with various stakeholders, including State Road Transport Corporations and transport operators, to facilitate smooth operations. Manage information related to court cases, legislative compliance, and transport services run by State Governments and Union Territories. Support in maintaining records and documentation for efficient decision-making.

Based on the roles and functions, the domain competencies identified across various officer levels are:

Domain Competencies	AS	Director	US	EE/ AEE	SO/ ASO
Policy formulation for all the new schemes, new programs related to Road Transport Sector					
Scope of subjects, services, related to Road Transport applicable to MoRTH					
Motor Vehicles Act, 1988					
Central Motor Vehicles Rules, 1989					
Road Transport Corporations Act, 1950					
Carriage by Road Act, 2007					
Assessment of performance of Road Transport schemes and prepare improvement					
Applicable rules, regulations, notifications, and conventions for vehicular traffic to and from					
Scope of subjects, services, related to Road Transport applicable to MoRTH					

Level of intervention as per competency need assessed

High	Moderate	Low
------	----------	-----

The behavioural and functional competencies mapped for the section are the follows:

Type	Competencies	AS	Director	US	EE/ AEE	SO/ ASO
Functional	Central Portals (e-office, NIC Portal, Grievance Portal, VIP Portal, Bhoomirashi Portal and any other relevant portal)					
	MS Office (Word, PowerPoint, Excel)					
	Government documentation (noting, drafting, cabinet notes, parliamentary answers, reports, Memorandum of Understanding etc.), reporting for parliamentary procedures, questions, and RTI queries					
	Financial procedures/ GFR/ Bill clearances/ PFMS					
	GRM (Grievance Redressal Mechanism), CPGRAMs and INGRAMs Portals					
	Government procurement protocols, processes, and tools (RFP, Tender Evaluation, Tender Award, Government e Marketplace - GeM) etc.)					
	Judicial Pronouncement and Restrictions, Audit Paras and Court Cases					
Behavioural	Verbal communication; Liaisoning and Negotiation skills					
	Multitasking and time management					
	Administrative and managerial skills					
	Stakeholder and people management					
	Gender sensitization and anti-sexual harassment					
	Organizational skills (such as planning, delegation, knowledge of key responsibility areas, goal setting, team building etc.)					
	Health and well-being, and stress management					
	Adaptation to new skills and methodologies					

Level of intervention as per competency need assessed

High	Moderate	Low
------	----------	-----

Training Need Assessment:

Type	Competency	Training Need Assessment
Domain	Policy formulation for all the new schemes, new programs related to Road Transport Sector	<ul style="list-style-type: none"> Induction/ refresher training to all officers
	Scope of subjects, services, related to Road Transport applicable to MoRTH	<ul style="list-style-type: none"> Induction/ refresher training to all officers
	Motor Vehicles Act, 1988	<ul style="list-style-type: none"> Induction material to be provided to all officers
	Central Motor Vehicles Rules, 1989	<ul style="list-style-type: none"> Induction material to be provided to all officers

	Road Transport Corporations Act, 1950	<ul style="list-style-type: none"> • Induction material to be provided to all officers
	Carriage by Road Act, 2007	<ul style="list-style-type: none"> • Induction material to be provided to all officers
	Assessment of performance of Road Transport schemes and prepare improvement	<ul style="list-style-type: none"> • Advanced data analytics training to be provided to officer US & below
	Applicable rules, regulations, notifications, and conventions for vehicular traffic to and from	<ul style="list-style-type: none"> • Induction material to be provided to all officers
	Scope of subjects, services, related to Road Transport applicable to MoRTH	<ul style="list-style-type: none"> • Induction material to be provided to all officers
Functional	Central Portals (e-office, NIC Portal, Grievance Portal, VIP Portal, Bhoomirashi Portal and any other relevant portal)	<ul style="list-style-type: none"> • Trainings on portals should be provided as part of induction/ refresher trainings to increase functional efficiency of the staff members.
	MS Office Skills (Word, PowerPoint, Excel)	<ul style="list-style-type: none"> • Trainings on MS office should be provided for better documentation, report writing, data management etc. • Advanced training to US and below. • Refresher/ induction training should be provided for all new joiners.
	Government documentation (noting, drafting, cabinet notes, parliamentary answers, reports, Memorandum of Understanding etc.), reporting for parliamentary procedures, questions, and RTI queries	<ul style="list-style-type: none"> • Trainings on Government documentation, protocols, processes, etc. should be provided to all staff members. • Trainings to be provided to all officers in positions and refresher/ induction trainings to be conducted for new joiners.
	Financial procedures/ GFR/ Bill clearances/ PFMS	<ul style="list-style-type: none"> • Basic knowledge of GFR/ Financial bills and operation of PFMS portal should be provided to all new joiners and other officers in position.
	GRM (Grievance Redressal Mechanism), CPGRAMs and INGRAMs Portals	<ul style="list-style-type: none"> • Trainings on portals should be provided as part of induction/ refresher trainings to increase functional efficiency of the staff members.
	Government procurement protocols, processes, and tools (RFP, Tender Evaluation, Tender Award, Government e Marketplace - GeM) etc.)	<ul style="list-style-type: none"> • Trainings on Government documentation, protocols, processes, understanding of tender, GeM portals etc. should be provided to all staff members. • Trainings to be provided to all officers in positions and refresher/ induction trainings to be conducted for new joiners.
	Judicial Pronouncement and Restrictions, Audit Paras and Court Cases	<ul style="list-style-type: none"> • Basic trainings to handle matters related to court and other PMO related Q&A should be provided to all officers. • Trainings should be made mandatory.
		<ul style="list-style-type: none"> • Effective communication plays a crucial role in handling day to day ministerial activities in both written and verbal form. It encourages effective dialogue. Negotiation, understanding on perspectives, building relationships and smooth transfer of knowledge. • Hence, communication trainings should be provided to all officer up to Director level.
Behavioural	Verbal communication; Liaisoning and Negotiation skills	<ul style="list-style-type: none"> • Effective communication plays a crucial role in handling day to day ministerial activities in both written and verbal form. It encourages effective dialogue. Negotiation, understanding on perspectives, building relationships and smooth transfer of knowledge. • Hence, communication trainings should be provided to all officer up to Director level.
	Multitasking and time management	<ul style="list-style-type: none"> • Trainings on multitasking and time management to be conducted for all officials to maintain healthy work life balance. • Advanced training for senior officers.
	Administrative and managerial skills	<ul style="list-style-type: none"> • To run an efficient team, training should be provided for enhancing the managerial skills of the section staff. It will increase the sense of decision making, communication, strategic planning etc. • Senior officials such as Director and above should be provided

		<p>with advanced level trainings to upskill.</p> <ul style="list-style-type: none"> • Induction / Refresher training to be provided for new joiners.
	Stakeholder and people management	<ul style="list-style-type: none"> • Trainings to handle and negotiate with stakeholders both internal and external shall be provided to the staffs for ease knowledge transfer through means of communication.
	Gender sensitization and anti-sexual harassment	<ul style="list-style-type: none"> • To promote inclusivity, enhance organizational culture, prevent harassment at workplace, regular trainings should be provided on sensitive topics such as sexual harassment. • Such interpersonal trainings should be conducted at regular intervals and these trainings should be mandatory for all designations.
	Organizational skills (such as planning, delegation, knowledge of key responsibility areas, goal setting, team building etc.)	<ul style="list-style-type: none"> • Regular upskilling required to enhance organizational skills for all employees (particularly senior officers) to delegate matters effectively,
	Health and well-being, and stress management	<ul style="list-style-type: none"> • Importance of proper healthy wellbeing should be taught to individuals. • Trainings on balancing health to be provided to officers of all level.
	Adaptation to new skills and methodologies	<ul style="list-style-type: none"> • Regular upskilling is essential to pace up with the existing technological advancements and hence trainings should be provided to all officials to increase adaptability to new technologies and their operating procedures.

2.6.2.3. Highways Wing

a) Highways Division

Figure 16: Organogram - Highways Division

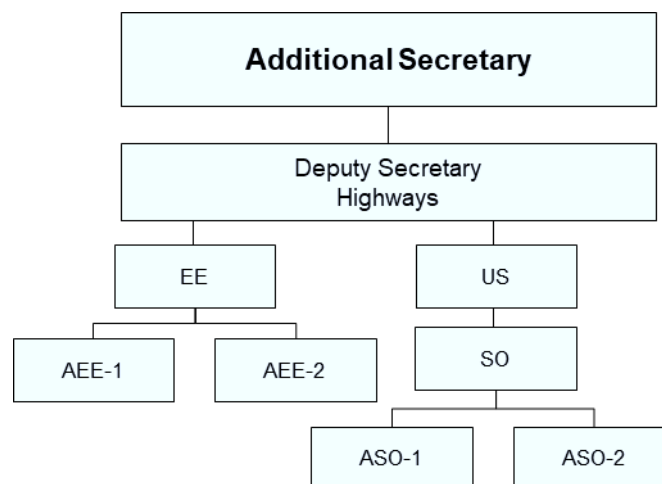

Key focus areas

- NHA related matters
- Implementation of projects and proposals
- Cabinet Matters
- Highway construction and maintenance Reporting

Role of Highways Division

- All NHDP projects (excluding NHDP IV A) relating to PPPAC, CCI/CCEA, and Cabinet.

- Processing of draft note for Cabinet Committee on Infrastructure (CCI/CCEA) in respect of projects being implemented by NHAI for approval of Competent Authority and matters pertaining to it.
- All NHAI related issues handled in the Ministry including projects assigned to NHAI requiring processing at Government level.
- Works of expressways in the Country.
- Matter pertaining to RFQ/REP documents for PPP projects.
- Review & Monitoring of Projects under NHDP being executed through NHAI.
- Inter-Ministerial/Inter-Departmental issues related to NHDP
- Budgetary proposals and release of funds under plan Budget to NHAI and monitoring of expenditure.
- Issues relating to NHAI Act and Rules and restructuring of NHAI.
- Parliamentary matters, coordination with NHAI in regard to proposals for foreign deputations, administrative reports and returns, Audit Paras and other miscellaneous issues relating to Policy matter.

Roles and functions of various officer levels:

Designation	Role and functions
Additional Secretary	<p>Additional Secretary heads the function for Highway section. There are various responsibilities with respect to crucial decision making linked with the role. Some of the key responsibilities include –</p> <ul style="list-style-type: none"> ○ Provide strategic leadership and oversight to the Highways Division. ○ Formulate policies and strategies for the implementation of National Highway Development Projects (NHDP). ○ Review and approve draft notes for the Cabinet Committee on Infrastructure (CCI/CCEA) for NHDP projects. ○ Handle high-level inter-ministerial and inter-departmental issues related to NHDP. ○ Monitor and review the progress of Highways & expressway projects across the country.
Deputy Secretary	<ul style="list-style-type: none"> ○ Process draft notes for CCI/CCEA and Cabinet in relation to NHAI projects and NHDP. ○ Handle NHAI-related issues within the Ministry, including those requiring processing at the government level. ○ Coordinate with NHAI for the review and monitoring of NHDP projects. ○ Address parliamentary matters related to NHDP and coordinate with NHAI on administrative reports, returns, and audit-related issues. ○ Manage budgetary proposals, release of funds, and monitoring of expenditure for NHAI under the plan budget.
Executive Engineer/ Assistant Executive Engineer	<ul style="list-style-type: none"> ○ Manage the planning and execution of NHDP projects, excluding NHDP IV A, and expressways. ○ Oversee the preparation of model RFQ/REP documents for PPP projects. ○ Coordinate with NHAI for the timely completion of projects and resolve on-site issues. ○ Monitor the progress of NHDP projects and ensure compliance with project timelines.

Designation	Role and functions
	<ul style="list-style-type: none"> ○ Provide technical expertise and guidance on highway engineering matters.
Under Secretary (US)	<ul style="list-style-type: none"> ○ Assist in the processing of draft notes for CCI/CCEA and Cabinet for NHDP projects. ○ Handle specific tasks related to NHAI, including project assignments requiring government-level processing. ○ Review and monitor NHDP projects executed through NHAI. ○ Assist in the coordination of inter-ministerial and inter-departmental issues related to NHDP. ○ Contribute to budgetary proposals, fund releases, and expenditure monitoring for NHAI.
Section Officer (SO)/ Assistant Section Officer (ASO)	<ul style="list-style-type: none"> ○ Handle administrative and coordination tasks within the Highways Division. ○ Assist in the preparation of documents for CCI/CCEA and Cabinet meetings. ○ Manage parliamentary matters related to NHDP and coordinate with NHAI on administrative reports and returns. ○ Provide administrative support for budgetary proposals, fund releases, and expenditure monitoring. ○ Coordinate with NHAI on proposals for data collection and policy matters.

Based on the roles and functions, the domain competencies identified across various officer levels are:

Domain Competencies	AS	DS	US	EE/ AEE	SO/ ASO
Highway constructions (Designing and Planning), and Land Acquisition related matters					
Highway maintenance and quality etc.					
Processing of draft note for Cabinet Committee on Economic Affairs (CCEA) in respect of projects which are implemented by National Highways Authority of India (NHAI) for necessary approvals					
Public Private Partnerships models, (DBFOT, HAM, TOT etc.), Model Concession Agreements, policies and regulations and related laws					
Right of Way matters and land usage					
Understanding of Detailed Project Report (DPR)					
Environmental Impact Assessment and environmental Management Plan					
Management of Special Infrastructural Projects which are under "Bharatmala Pariyojna" of National Highways Development					
Contract management and administration					
Arbitration and dispute resolution					
Latest practices and technologies related to					

Domain Competencies	AS	DS	US	EE/ AEE	SO/ ASO
design, construction, maintenance & materials used in highways					

Level of intervention as per competency need assessed

High	Moderate	Low
------	----------	-----

The behavioural and functional competencies mapped for the section are the follows:

Type	Competencies	AS	DS	US	EE/ AEE	SO/ ASO
Functional	Central Portals (e-office, NIC Portal, Grievance Portal, VIP Portal, Bhoomirashi Portal and any other relevant portal)					
	MS Office (Word, PowerPoint, Excel)					
	Government documentation (noting, drafting, cabinet notes, parliamentary answers, reports, Memorandum of Understanding etc.), reporting for parliamentary procedures, questions, and RTI queries					
	Financial procedures/ GFR/ Bill clearances/ PFMS					
	GRM (Grievance Redressal Mechanism), CPGRAMs and INGRAMs Portals					
	Government procurement protocols, processes, and tools (RFP, Tender Evaluation, Tender Award, Government e Marketplace - GeM) etc.)					
	Judicial Pronouncement and Restrictions, Audit Paras and Court Cases					
Behavioural	Verbal communication; Liaisoning and Negotiation skills					
	Multitasking and time management					
	Administrative and managerial skills					
	Stakeholder and people management					
	Gender sensitization and anti-sexual harassment					
	Organizational skills (such as planning, delegation, knowledge of key responsibility areas, goal setting, team building etc.)					
	Health and well-being, and stress management					
	Adaptation to new skills and methodologies					

Level of intervention as per competency need assessed

High	Moderate	Low
------	----------	-----

Training Need Assessment:

Type	Competency	Training Need Assessment
------	------------	--------------------------

Type	Competency	Training Need Assessment
Domain	Highway constructions (Designing and Planning), and Land Acquisition related matters	<ul style="list-style-type: none"> Basic training for administrative officers and advanced training for technical officers (EE/ AEE)
	Highway maintenance and quality etc.	<ul style="list-style-type: none"> Basic training for administrative officers and advanced training for technical officers (EE/ AEE)
	Processing of draft note for Cabinet Committee on Economic Affairs (CCEA) in respect of projects which are implemented by National Highways Authority of India (NHAI) for necessary approvals	<ul style="list-style-type: none"> Trainings on Drafting of cabinet notes and the processes involved for all officers. Advanced training for DS, US, SO & ASOs
	Public Private Partnerships models, (DBFOT, HAM, TOT etc.), Model Concession Agreements, policies and regulations and related laws	<ul style="list-style-type: none"> Trainings on PPP and other development models to be provided for senior officials (DS & below)
	Right of Way matters and land usage	<ul style="list-style-type: none"> Advanced trainings for technical officers Basic level training for new joiners should also be conducted
	Understanding of Detailed Project Report (DPR)	<ul style="list-style-type: none"> Trainings on preparation of DPR to be provided to all technical officers to enhance the project delivery and manage tasks.
	Environmental Impact Assessment and environmental Management Plan	<ul style="list-style-type: none"> Trainings on Environmental impact assessment should be provided as mandatory trainings
	Management of Special Infrastructural Projects which are under "Bharatmala Pariyojna" of National Highways Development	<ul style="list-style-type: none"> Induction/ refresher material on Bharatmala Pariyojna to be provided to all staff. Advanced training for senior officers (DS& above) and technical officers
	Contract management and administration	<ul style="list-style-type: none"> Advanced training for senior officers (DS& above) and technical officers
	Arbitration and dispute resolution	<ul style="list-style-type: none"> Advanced training for senior officers (DS& above) and technical officers
	Latest practices and technologies related to design, construction, maintenance & materials used in highways	<ul style="list-style-type: none"> Basic training for officers (US & above) and advanced training for technical officers
Functional	Central Portals (e-office, NIC Portal, Grievance Portal, VIP Portal, Bhoomirashi Portal and any other relevant portal)	<ul style="list-style-type: none"> Trainings on portals should be provided as part of induction/ refresher trainings to increase functional efficiency of the staff members.
	MS Office (Word, PowerPoint, Excel)	<ul style="list-style-type: none"> Trainings on MS office should be provided for better documentation, report writing, data management etc. Refresher/ induction training should be provided for all officers/ new joiners. Advanced training for EE/ SO& above
	Government documentation (noting, drafting, cabinet notes, parliamentary answers, reports, Memorandum of Understanding etc.), reporting for parliamentary procedures, questions, and RTI queries	<ul style="list-style-type: none"> Trainings on Government documentation, protocols, processes, etc. should be provided to all staff members. Basic trainings to be provided to all officers in positions and refresher/ induction trainings to be conducted for new joiners.
	Financial procedures/ GFR/ Bill clearances/ PFMS	<ul style="list-style-type: none"> Basic knowledge of GFR/ Financial bills and operation of PFMS portal should be provided to all new joiners and other officers in position.
	GRM (Grievance Redressal Mechanism), CPGRAMs and INGRAMs Portals	<ul style="list-style-type: none"> Trainings on portals should be provided as part of induction/ refresher trainings to increase functional efficiency of the staff members.
Government procurement protocols, processes, and tools (RFP, Tender Evaluation, Tender Award, Government	<ul style="list-style-type: none"> Trainings on Government documentation, protocols, processes, understanding of tender, GeM portals etc. should be provided to all staff members. 	

Type	Competency	Training Need Assessment
	e Marketplace - GeM) etc.)	<ul style="list-style-type: none"> Trainings to be provided to all officers in positions and refresher/ induction trainings to be conducted for new joiners.
	Judicial Pronouncement and Restrictions, Audit Paras and Court Cases	<ul style="list-style-type: none"> Basic trainings to handle matters related to court and other PMO related Q&A should be provided to all officers. Trainings should be made mandatory.
Behavioural	Verbal communication; Liaisoning and Negotiation skills	<ul style="list-style-type: none"> Advanced communication trainings should be provided across all designation levels from ASO to US. Basic training to officers (DS & above)
	Multitasking and time management	<ul style="list-style-type: none"> Trainings on multitasking and time management to be conducted for senior officials (US & above) Basic training to Officers (EE/SO & below)
	Administrative and managerial skills	<ul style="list-style-type: none"> Officials (DS and below) should be provided with advanced level trainings to upskill.
	Stakeholder and people management	<ul style="list-style-type: none"> Officials (DS and below) should be provided with advanced level trainings to upskill.
	Gender sensitization and anti-sexual harassment	<ul style="list-style-type: none"> To promote inclusivity, enhance organizational culture, prevent harassment at workplace, regular trainings should be provided on sensitive topics such as sexual harassment. Such interpersonal trainings should be conducted at regular intervals and these trainings should be mandatory for all designations.
	Organizational skills (such as planning, delegation, knowledge of key responsibility areas, goal setting, team building etc.)	<ul style="list-style-type: none"> Regular upskilling (for DS & above) required to enhance organizational skills for all employees to delegate matters effectively. Advanced training for US & below
	Health and well-being, and stress management	<ul style="list-style-type: none"> Trainings on balancing health to be provided to officers of all level.
	Adaptation to new skills and methodologies	<ul style="list-style-type: none"> Regular upskilling is essential to pace up with the existing technological advancements and hence trainings should be provided to all officials to increase adaptability to new technologies and their operating procedures.

Figure 17: Organogram - Land Acquisition Division

b) Land Acquisition Division

Land Acquisition Wing works closely with the Highways division. It handles subjects related to land acquisition, environmental and forest clearances for Highway Development Projects.

Key focus areas

- Clearances for land acquisition and
- Other matters related to project clearance such as environmental, forest etc.

Role of Land Acquisition Division

- This Division is responsible for managing guidelines, Acts, portals, and field functioning related to land acquisition.
- The wing is responsible for two main verticals, planning and field work.
- Officials such as SO, ASO handles file initiation, proposals management, system management, court cases, public grievances etc.
- Senior officials usually handle the advisory and the decision-making matters.

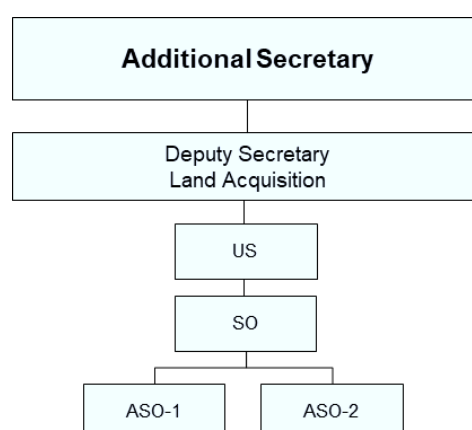

- Works in proximity with the state governments, local / regional institutions/ State PWDs.
- Frames, reviews, and monitors the policy related to land acquisition, building, maintenance, management, and operation of National Highways
- Works on administration of National Highway (Land and Traffic) Control Act, 2002
- Manages highway administration.
- Manages proposals of transfer of Defence land required for the construction of National Highway Projects
- Handles legal and constitutional issues.
- Manages land acquisition under National Highways Act 1956 and frames rules.
- Manages review and updating of the Bhoomirashi Portal and related issues.

Roles and functions of various officer levels:

Designation	Role and functions
Additional Secretary (AS)	<p>In-charge overall administration of the section and the following on key tasks on a regular basis.</p> <ul style="list-style-type: none"> ○ Oversee the overall functioning of the Land Acquisition Division, ensuring effective implementation of guidelines, Acts, and policies. ○ Coordinate with state governments, local/regional institutions, and State Public Works Departments (PWDs) to facilitate land acquisition processes. ○ Review and monitor the policy framework related to land acquisition, building, maintenance, management, and operation of National Highways. ○ Handle advisory and decision-making matters, providing strategic direction to the division. ○ Manage legal and constitutional issues related to land acquisition and National Highways Act, 1956.
Deputy Secretary (DS)	<p>Provides administrative support to the division. Major key roles include closely monitoring day to day tasks.</p> <ul style="list-style-type: none"> ○ Assist in the formulation and review of policies related to land acquisition for National Highway projects. ○ Coordinate with senior officials and state authorities to streamline fieldwork processes and address public grievances. ○ Manage proposals for the transfer of Defence land required for National Highway construction. ○ Supervise the administration of the National Highway (Land and Traffic) Control Act, 2002. ○ Oversee the planning and execution of land acquisition strategies in collaboration with field officials.
Under Secretary (US)	<ul style="list-style-type: none"> ○ Proposal management, and system management related to land acquisition. ○ Manage court cases and public grievances, ensuring timely resolution and compliance with regulations. ○ Assist in the framing and updating of rules under the National Highways Act, 1956. ○ Work closely with state authorities and regional institutions to facilitate the smooth functioning of land acquisition processes. ○ Support senior officials in decision-making matters and provide administrative support for policy-related tasks.
Section Officer (SO)/ Assistant Section Officer (ASO)	<ul style="list-style-type: none"> ○ Handling grievances related to Land Acquisition ○ Court cases related to Compensation for land. ○ Bill clearances ○ Contempt petition of the various courts. ○ Training Programme of Bhoomirashi Portal 2.0 6. ○ Handling grievances related to the Land Acquisition ○ V.I.P references. ○ P.M.O references & Cabinet Secretariat matters. ○ Miscellaneous matters related to grievances and other issues. ○ Assisting senior officers in other tasks

Based on the roles and functions, the domain competencies identified across various officer levels are:

Domain Competencies	AS	DS	US	SO	ASO
Acts and amendments (Right to fair Compensation and transparency in Land Acquisition, Rehabilitation and Resettlement Act, 2013)					
Land Acquisition Manual					
National Highways Control Act,2002 etc.) / guidelines related to land acquisition matters					
Laws, Rules, Guidelines processes related to Environment/Forests/Wildlife Clearances for highway projects					
Managing field inspections of land					
Matters related to Highway Administration					
Project Appraisal, project procedure, Project estimation, Project sanction process as per Ministry and Government of India rules					

Level of intervention as per competency need assessed

High	Moderate	Low
------	----------	-----

The behavioural and functional competencies mapped for the section are the follows:

Type	Competencies	AS	DS	US	SO	ASO
Functional	Central Portals (e-office, NIC Portal, Grievance Portal, VIP Portal, Bhoomirashi Portal and any other relevant portal)					
	MS Office (Word, PowerPoint, Excel)					
	Government documentation (noting, drafting, cabinet notes, parliamentary answers, reports, Memorandum of Understanding etc.), reporting for parliamentary procedures, questions, and RTI queries					
	Financial procedures/ GFR/ Bill clearances/ PFMS					
	GRM (Grievance Redressal Mechanism), CPGRAMs and INGRAMs Portals					
	Government procurement protocols, processes, and tools (RFP, Tender Evaluation, Tender Award, Government e Marketplace - GeM) etc.)					
	Judicial Pronouncement and Restrictions, Audit Paras and Court Cases					
Behavioural	Verbal communication; Liaisoning and Negotiation skills					
	Multitasking and time management					
	Administrative and managerial skills					
	Stakeholder and people management					
	Gender sensitization and anti-sexual harassment					
	Organizational skills (such as planning, delegation, knowledge of key responsibility areas, goal setting, team building etc.)					

Type	Competencies	AS	DS	US	SO	ASO
	Health and well-being, and stress management					
	Adaptation to new skills and methodologies					

Level of intervention as per competency need assessed

High

Moderate

Low

Training Need Assessment

Type	Competency	Training Need Assessment
Domain	Acts and amendments (Right to fair Compensation and transparency in Land Acquisition, Rehabilitation and Resettlement Act, 2013)	<ul style="list-style-type: none"> Basic level induction material for new joiners. Session/ workshops by senior officers should also be conducted.
	Land Acquisition Manual	<ul style="list-style-type: none"> Basic level induction material for new joiners. Session/ workshops by senior officers should also be conducted.
	National Highways Control Act,2002 etc. / guidelines related to land acquisition matters	<ul style="list-style-type: none"> Basic level induction material for new joiners. Session/ workshops by senior officers should also be conducted.
	Laws, Rules, Guidelines processes related to Environment/Forests/Wildlife Clearances for highway projects	<ul style="list-style-type: none"> Basic level induction material for new joiners. Session/ workshops by senior officers should also be conducted.
	Managing field inspections of land	<ul style="list-style-type: none"> Field inspection training/ workshops for DS and below
	Matters related to Highway Administration	<ul style="list-style-type: none"> Senior officers should be provided advanced trainings for the same. Basic level training for junior officers (US & below, along with new joiners.
	Project Appraisal, project procedure, Project estimation, Project sanction process as per Ministry and Government of India rules	<ul style="list-style-type: none"> Advanced Project appraisal training for AS & DS Refresher training for junior officers (US & below)
Functional	Central Portals (e-office, NIC Portal, Grievance Portal, VIP Portal, Bhoomirashi Portal and any other relevant portal)	<ul style="list-style-type: none"> Trainings on portals should be provided as part of induction/ refresher trainings to increase functional efficiency of the staff members.
	MS Office (Word, PowerPoint, Excel)	<ul style="list-style-type: none"> Trainings on MS office should be provided for better documentation, report writing, data management etc. Refresher/ induction training should be provided for all new joiners. Advanced training for SO/ ASOs
	Government documentation (noting, drafting, cabinet notes, parliamentary answers, reports, Memorandum of Understanding etc.), reporting for parliamentary procedures, questions, and RTI queries	<ul style="list-style-type: none"> Trainings on Government documentation, protocols, processes, etc. should be provided to all staff members. Basic trainings to be provided to all officers in positions and refresher/ induction trainings to be conducted for new joiners.
	Financial procedures/ GFR/ Bill clearances/ PFMS	<ul style="list-style-type: none"> Basic knowledge of GFR/ Financial bills and operation of PFMS portal should be provided to all new joiners and other officers in position.
	GRM (Grievance Redressal Mechanism), CPGRAMs and INGRAMs Portals	<ul style="list-style-type: none"> Trainings on portals should be provided as part of induction/ refresher trainings to increase functional efficiency of the staff members.
	Government procurement protocols, processes, and tools (RFP, Tender Evaluation, Tender Award, Government e Marketplace - GeM) etc.)	<ul style="list-style-type: none"> Trainings on Government documentation, protocols, processes, understanding of tender, GeM portals etc. should be provided to all staff members. Trainings to be provided to all officers in positions and refresher/ induction trainings to be conducted for new

Type	Competency	Training Need Assessment
		joiners.
	Judicial Pronouncement and Restrictions, Audit Paras and Court Cases	<ul style="list-style-type: none"> Basic trainings to handle matters related to court and other PMO related Q&A should be provided to all officers. Trainings should be made mandatory.
Behavioural	Verbal communication; Liaisoning and Negotiation skills	<ul style="list-style-type: none"> Effective communication plays a crucial role in handling day to day ministerial activities in both written and verbal form. It encourages effective dialogue. Negotiation, understanding on perspectives, building relationships and smooth transfer of knowledge. Hence, communication trainings should be provided across all designation levels from ASO to AS.
	Multitasking and time management	<ul style="list-style-type: none"> Trainings on multitasking and time management to be conducted for senior officials.
	Administrative and managerial skills	<ul style="list-style-type: none"> Senior officials (DS and above) should be provided with advanced level trainings to upskill. Induction / Refresher training to be provided for new joiners.
	Stakeholder and people management	<ul style="list-style-type: none"> Trainings to handle and negotiate with stakeholders both internal and external shall be provided to the staffs for ease knowledge transfer through means of communication.
	Gender sensitization and anti-sexual harassment	<ul style="list-style-type: none"> To promote inclusivity, enhance organizational culture, prevent harassment at workplace, regular trainings should be provided on sensitive topics such as sexual harassment. Such interpersonal trainings should be conducted at regular intervals and these trainings should be mandatory for all designations.
	Organizational skills (such as planning, delegation, knowledge of key responsibility areas, goal setting, team building etc.)	<ul style="list-style-type: none"> Regular upskilling (for DS & above) required to enhance organizational skills for all employees to delegate matters effectively.
	Health and well-being, and stress management	<ul style="list-style-type: none"> Trainings on balancing health to be provided to officers of all level.
	Adaptation to new skills and methodologies	<ul style="list-style-type: none"> Regular upskilling is essential to pace up with the existing technological advancements and hence trainings should be provided to all officials to increase adaptability to new technologies and their operating procedures.

2.6.2.4. Logistics Section

The division is headed by Joint Secretary. The logistics section is responsible for matters related to civil engineering and works & policies related to logistics parks, MMLPs, development of ropeways, supply chain, warehousing etc. Further, the Section handles functions such as monitoring of National Logistics Policy, strategic oversight for commercial operations of MMLPs, project management for ropeway engineering projects and other aspects of Infrastructure development such as Public Private Partnership (PPP) throughout the country.

Figure 18: Organogram – Logistics Section

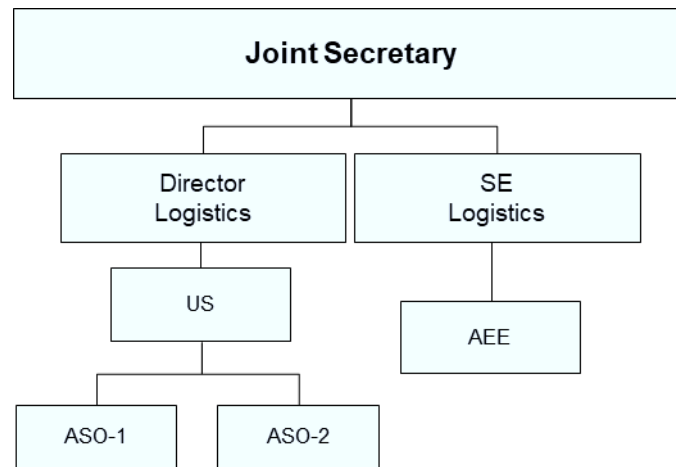

Key focus areas

- Multimodal Logistics Parks (MMLP)
- Ropeways

Role of Logistics Section

- Implementation of any other projects/programmes to bring about Logistic Efficiency Enhancement, including initiatives under BMP to bring about corridor efficiency based on O-D studies of freight movement.
- Development of Multi-modal logistics parks (MMLPs) across Country
- Inter-ministerial coordination for implementation of Logistics Efficiency Enhancement Program (LEEP)
- Improve connectivity to ports across country
- Works related to development of Ropeways and other innovative/ alternate mobility solutions
- Planning and implementation of Inter-modal stations (IMS)
- Initiatives related to Freight Logistics and Transportation including various business models (Hub & Spoke, Point to Point), multimodal operations, etc.

Roles and functions of various officer levels:

Designation	Role and functions
Joint Secretary	<p>In-charge of the Logistics Section – Overall administration of the section and the following on key tasks on a regular basis. Also, aids on tasks provided by the Hon'ble Minister. Key tasks managed by Joint Secretary include –</p> <ul style="list-style-type: none"> ○ Matters related to National Logistics Policy ○ Routine review of the tasks assigned as per the Ministry's Mandate ○ Setting up measurable and identifiable intermittent milestones ○ Planning for achieving overall targets for the Section ○ Mid-course correction as required. ○ Stakeholder management both internal/ external ○ Comments on Cabinet Notes, Policy Issues –State Bills of other Ministries-Departments ○ Court Cases ○ VIP Matters ○ PMO References

Designation	Role and functions
Director	<p>Provides administrative support to logistics division. Takes orders from the Joint Secretary/Additional Secretary/Secretary on important matters related to the Section. Major key roles include closely monitoring day to day tasks.</p> <ul style="list-style-type: none"> ○ Handling routine tasks and frameworks of the Section ○ Providing final reviews to the documents/ reports ○ Preparation of annual plan for logistics ○ Addressing RTI matters and Public Grievances ○ Matters related to press release. ○ Working on authentication of information. ○ Administrative matters related to logistics Section. ○ Handling cabinet related matters such as important bills, VIP matters ○ PMO references ○ Other miscellaneous tasks
Superintending Engineer (SE)	<p>SE handles technical matters pertaining to ropeways, logistics park designing, setting technical criteria for the tenders, and assisting in other technical activities related to logistics section. Some key tasks include –</p> <ul style="list-style-type: none"> ○ Assisting in technical decisions and reviews ○ Leading in planning and executing the tasks related to logistics development. ○ Project management activities ○ Provide inputs related to annual plan ○ Providing technical expertise in civil engineering, infrastructure design, and construction methodologies ○ Addressing RTI matters and Public Grievances ○ Handling cabinet related matters such as important bills, VIP matters ○ PMO references
Under Secretary	<p>Assists in the administrative tasks related to day-to-day activities and provides administrative support to the Director. Key tasks include:</p> <ul style="list-style-type: none"> ○ Preparation of annual plan for logistics/media ○ Administrative support in policy formulation and assistance ○ Assisting in development of implementation framework ○ Dealing with matters related to ropeways, NHIDCL etc. ○ Review of proposals ○ Addressing RTI matters and Public Grievances ○ Handling parliamentary matters and some other miscellaneous tasks
Assistant Executive Engineer	<p>Assisting the senior engineer officers such as SE to handle the technical expertise required in the project management activities. Key responsibilities include –</p> <ul style="list-style-type: none"> ○ Assisting in technical decisions and reviews done by SE ○ Assisting in planning and executing the tasks related to logistics development. ○ Providing support in Project management activities ○ Supporting in other tasks on site.
Section Officer / Assistant Section Officer	<ul style="list-style-type: none"> • Aid the Director and other senior officials for coordination of work among the subordinate staffs. SO's and ASO's play a crucial role for the work distribution in the section, their responsibilities start from the very beginning of any process and are responsible for managing the entire process. <ul style="list-style-type: none"> ○ Initiation of files and drafts, letters, notices etc. ○ Managing eOffice, ○ Handling public grievances and RTI related matters ○ Preparing cabinet notes, bills, PMO references ○ Other miscellaneous tasks as allocated by senior authorities which can be widely ranging from technical to non – technical such as planning, operations related task etc.

Based on the roles and functions, the domain competencies identified across various officer levels are:

Domain Competencies	JS	Director	SE	US	AEE	SO/ASO
Civil engineering knowledge for logistics parks			High		High	
National Logistics Policy		High	High			
Multi Modal Logistics Parks - objectives, benefits, target beneficiaries, eligibility, and implementation of projects MMLP		High				
Commercial Operations of MMLPs		High				
Logistics Efficiency Enhancement Program (LEEP)		High			High	
Project Management, controlling and reporting including various project management tools and techniques.		High	High		High	
Freight Logistics and Transportation including various business models (Hub & Spoke, Point to Point), multimodal operations, etc.		High	High			
Ropeway engineering, technologies, and operations						
Public Private Partnership Models (Design, Build, Finance, Operate and Transfer (DBFOT) mode)			High			

Level of intervention as per competency need assessed

High	Moderate	Low
------	----------	-----

The behavioural and functional competencies mapped for the section are the follows:

Type	Competencies	JS	Director	SE	US	AEE	SO/ASO
Functional	Central Portals (e-office, NIC Portal, Grievance Portal, VIP Portal, Bhoomirashi Portal and any other relevant portal)						High
	MS Office (Word, PowerPoint, Excel)				High	High	High
	Government documentation (noting, drafting, cabinet notes, parliamentary answers, reports, Memorandum of Understanding etc.), reporting for parliamentary procedures, questions, and RTI queries						High
	Financial procedures/ GFR/ Bill clearances/ PFMS						High
	GRM (Grievance Redressal Mechanism), CPGRAMs and INGRAMs Portals				High		High
	Government procurement protocols, processes, and tools (RFP, Tender Evaluation, Tender Award, Government e Marketplace - GeM) etc.)						High
Be	Verbal communication; Liaisoning and Negotiation skills						High

Type	Competencies	JS	Director	SE	US	AEE	SO/ASO
	Multitasking and time management						
	Administrative and managerial skills						
	Stakeholder and people management						
	Gender sensitization and anti-sexual harassment						
	Organizational skills (such as planning, delegation, knowledge of key responsibility areas, goal setting, team building etc.)						
	Health and well-being, and stress management						
	Adaptation to new skills and methodologies						

Level of intervention as per competency need assessed

High	Moderate	Low
------	----------	-----

Training Need Assessment:

Type	Competency	Training Need Assessment
Domain	Civil engineering knowledge for logistics parks	<ul style="list-style-type: none"> Domain specific trainings on civil engineering, basic concepts of logistics etc. for Technical Officers (SE & AEE) Intermediate level training for Administrative Officers
	National Logistics Policy etc.	<ul style="list-style-type: none"> Understanding of National logistics policy and its amendments. Trainings should be provided to all officers. Advanced level training for SE/ Director and above. New joiners should be given refresher/ induction training on the same.
	Multi Modal Logistics Parks - objectives, benefits, target beneficiaries, eligibility, and implementation of projects MMLP	<ul style="list-style-type: none"> Trainings on logistics policy, Commercial operations of MMLPs, and ropeways to be provided for senior officials such as Director and above and technical staff such as SE, AEE. Refresher/ induction training to be provided to new joiners and senior officers in position.
	Commercial Operations of MMLPs	<ul style="list-style-type: none"> Advanced trainings on Commercial operations of MMLPs to be provided for senior officials such as Director and above. Basic/ Intermediate training for US and below (including AEE)
	Logistics Efficiency Enhancement Program (LEEP)	<ul style="list-style-type: none"> Trainings on LEEP program should be conducted for all officers. Induction/ refresher material to be prepared for all new joiners.
	Project Management, controlling and reporting including various project management tools and techniques.	<ul style="list-style-type: none"> Trainings on project management to be provided for better utilisation of resources, adaptability, more time management, and better on-site operations etc. Senior officers should be provided advanced trainings for the same. Basic level training for new joiners should also be conducted.
	Freight Logistics and Transportation including various business models (Hub & Spoke, Point to Point), multimodal operations, etc.	<ul style="list-style-type: none"> Trainings on freight logistics/ transportation and various business models to upskilling of the team. Advanced training for SE/ Director & above.

	Ropeway engineering, technologies, and operations	<ul style="list-style-type: none"> Intermediate level trainings on ropeways to be provided all senior officials such as Director and technical staff such as SE, AEE. Basic training for US and below. Induction training to all new joiners.
	Public Private Partnership Models (Design, Build, Finance, Operate and Transfer (DBFOT) mode)	<ul style="list-style-type: none"> Trainings on PPP, new project scope, and other partnership models to be provided for senior officials such as Director and above and technical staff such as SE, AEE.
Functional	Central Portals (e-office, NIC Portal, Grievance Portal, VIP Portal, Bhoomirashi Portal and any other relevant portal)	<ul style="list-style-type: none"> Trainings on portals should be provided as part of induction/ refresher trainings to increase functional efficiency of the staff members.
	MS Office Skills (Word, PowerPoint, Excel)	<ul style="list-style-type: none"> Trainings on MS office should be provided for better documentation, report writing, data management etc. Advanced training to US and below. Refresher/ induction training should be provided for all new joiners.
	Government documentation (noting, drafting, cabinet notes, parliamentary answers, reports, Memorandum of Understanding etc.), reporting for parliamentary procedures, questions, and RTI queries	<ul style="list-style-type: none"> Trainings on Government documentation, protocols, processes, etc. should be provided to all staff members. Trainings to be provided to all officers in positions and refresher/ induction trainings to be conducted for new joiners.
	Financial procedures/ GFR/ Bill clearances/ PFMS	<ul style="list-style-type: none"> Basic knowledge of GFR/ Financial bills and operation of PFMS portal should be provided to all new joiners and other officers in position.
	GRM (Grievance Redressal Mechanism), CPGRAMs and INGRAMs Portals	<ul style="list-style-type: none"> Trainings on portals should be provided as part of induction/ refresher trainings to increase functional efficiency of the staff members.
	Government procurement protocols, processes, and tools (RFP, Tender Evaluation, Tender Award, Government e Marketplace - GeM) etc.)	<ul style="list-style-type: none"> Trainings on Government documentation, protocols, processes, understanding of tender, GeM portals etc. should be provided to all staff members. Trainings to be provided to all officers in positions and refresher/ induction trainings to be conducted for new joiners.
	Judicial Pronouncement and Restrictions, Audit Paras and Court Cases	<ul style="list-style-type: none"> Basic trainings to handle matters related to court and other PMO related Q&A should be provided to all officers. Trainings should be made mandatory.
Behavioural	Verbal communication; Liaisoning and Negotiation skills	<ul style="list-style-type: none"> Effective communication plays a crucial role in handling day to day ministerial activities in both written and verbal form. It encourages effective dialogue. Negotiation, understanding on perspectives, building relationships and smooth transfer of knowledge. Hence, communication trainings should be provided to all officer up to Director level.
	Multitasking and time management	<ul style="list-style-type: none"> Trainings on multitasking and time management to be conducted for all officials to maintain healthy work life balance. Advanced training for senior officers.
	Administrative and managerial skills	<ul style="list-style-type: none"> To run an efficient team, training should be provided for enhancing the managerial skills of the section staff. It will increase the sense of decision making, communication, strategic planning etc. Senior officials such as Director and above should be provided with advanced level trainings to upskill.

		<ul style="list-style-type: none"> • Induction / Refresher training to be provided for new joiners.
	Stakeholder and people management	<ul style="list-style-type: none"> • Trainings to handle and negotiate with stakeholders both internal and external shall be provided to the staffs for ease knowledge transfer through means of communication.
	Gender sensitization and anti-sexual harassment	<ul style="list-style-type: none"> • To promote inclusivity, enhance organizational culture, prevent harassment at workplace, regular trainings should be provided on sensitive topics such as sexual harassment. • Such interpersonal trainings should be conducted at regular intervals and these trainings should be mandatory for all designations.
	Organizational skills (such as planning, delegation, knowledge of key responsibility areas, goal setting, team building etc.)	<ul style="list-style-type: none"> • Regular upskilling required to enhance organizational skills for all employees (particularly senior officers) to delegate matters effectively,
	Health and well-being, and stress management	<ul style="list-style-type: none"> • Importance of proper healthy wellbeing should be taught to individuals. • Trainings on balancing health to be provided to officers of all level.
	Adaptation to new skills and methodologies	<ul style="list-style-type: none"> • Regular upskilling is essential to pace up with the existing technological advancements and hence trainings should be provided to all officials to increase adaptability to new technologies and their operating procedures.

2.6.2.5. Toll Division

Figure 19: Organogram - Toll Division

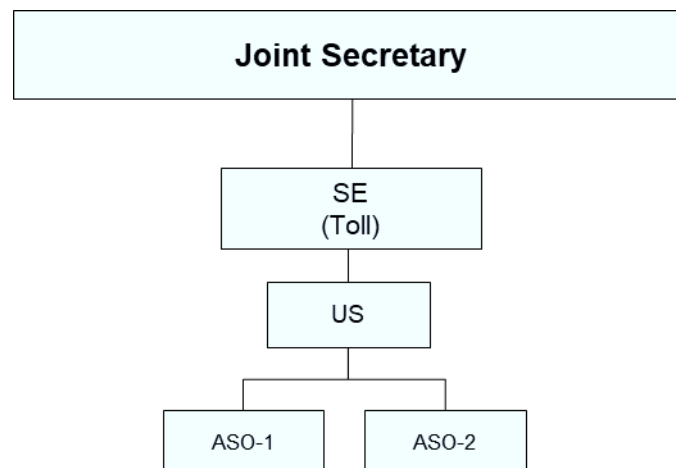

Key focus areas

- User Fee (Toll) and related policies
- Electronic Toll Collection (ETC) System

Role of Toll Division

- This Division deals with Creation or modification of User Fee (Toll) policies or regulations, according to Cabinet.
- About National Roads, Toll Notification is important.
- Legal challenges to the application of user fee regulations.
- Requests for user fee exemptions from private parties, public entities, and state governments.

- Handling complaints against user fees for various transport organizations, including the All-India Motor Transport Congress and the All-India Confederation of Goods Vehicle Owners' Association, among others.
- Development of policies and issues related to electronic toll collection system.
- Creation of various user fee policy reports and refund
- Disseminating information about the Ministry's User Fee policy to other divisions.
- Any other User Fee tasks that may be assigned.
- Coordinating user fee concerns with the NHAI, other departments, and state governments.
- Publication of instructions and explanations about the User fee policy.
- Planning multiple meetings on the topics covered.
- User fee policy-related parliamentary questions and other business.
- Dispensing data under the RTI Act.

Roles and functions of various officer levels:

Designation	Role and functions
JS	<ul style="list-style-type: none"> ○ Lead the creation or modification of User Fee (Toll) policies and regulations in accordance with Cabinet directives. ○ Develop and implement policies related to electronic toll collection systems, ensuring alignment with national road requirements. ○ Address legal challenges to the application of user fee regulations, providing strategic guidance to overcome legal obstacles. ○ Evaluate and respond to requests for user fee exemptions from private parties, public entities, and state governments. ○ Coordinate user fee concerns with the NHAI, other government departments, and state governments, fostering collaboration and efficient resolution. ○ Disseminate information about the Ministry's User Fee policy to other divisions and stakeholders.
SE (Toll)	<ul style="list-style-type: none"> ○ Provide technical expertise in the planning and development of toll infrastructure, ensuring alignment with User Fee policies. ○ Oversee the creation of various user fee policy reports ○ Address and resolve complaints against user fees for various transport organizations, including those from the All-India Motor Transport Congress and the All-India Confederation of Goods Vehicle Owners' Association. ○ Contribute to the planning and execution of parliamentary questions and other business related to user fee policies.
US	<ul style="list-style-type: none"> ○ Evaluate and process requests for user fee exemptions from private parties, public entities, and state governments. ○ Provide administrative support for the handling of legal challenges related to user fee regulations ○ Dispense data under the RTI Act, ensuring transparency and compliance with regulatory requirements. ○ Assist in the coordination of user fee concerns with NHAI, other departments, and state governments. ○ Coordinate and plan multiple meetings on topics related to toll policies, electronic toll collection, and infrastructure development. ○ Support the publication of instructions and explanations about the User Fee policy.
ASO	<ul style="list-style-type: none"> ○ Manage data related to user fee policies, toll notifications, and requests for exemptions. ○ Support the creation of various user fee policy reports. ○ Provide support in disseminating information about the Ministry's User Fee policy to other divisions and stakeholders. ○ Assist in the publication of instructions and explanations about the User Fee policy. ○ Coordinate administrative tasks related to toll policies, including handling parliamentary questions and other business.

Based on the roles and functions, the domain competencies identified across various officer levels are:

Domain Competencies	JS	SE	US	ASO
Policy / Rule drafting on toll domain				
Acts, Laws, rules, guidelines, notifications and amendments on matter related to land, user fee, toll collection etc.				
Preparation of or modification of User Fee (Toll) policies or regulations, according to Cabinet				
Managing complaints against user fees brought up by various transport organizations				
Managing user fee concerns with the NHAI, other departments, and state government				
Implementation of Toll Collection System				

Level of intervention as per competency need assessed

High	Moderate	Low
------	----------	-----

The behavioural and functional competencies mapped for the section are the follows:

Type	Competencies	JS	SE	US	ASO
Functional	Central Portals (e-office, NIC Portal, Grievance Portal, VIP Portal, Bhoomirashi Portal and any other relevant portal)				
	MS Office (Word, PowerPoint, Excel)				
	Government documentation (noting, drafting, cabinet notes, parliamentary answers, reports, Memorandum of Understanding etc.), reporting for parliamentary procedures, questions, and RTI queries				
	Financial procedures/ GFR/ Bill clearances/ PFMS				
	GRM (Grievance Redressal Mechanism), CPGRAMs and INGRAMs Portals				
	Government procurement protocols, processes, and tools (RFP, Tender Evaluation, Tender Award, Government e Marketplace - GeM) etc.)				
	Judicial Pronouncement and Restrictions, Audit Paras and Court Cases				
Behavioural	Verbal communication; Liaisoning and Negotiation skills				
	Multitasking and time management				
	Administrative and managerial skills				

Type	Competencies	JS	SE	US	ASO
	Stakeholder and people management				
	Gender sensitization and anti-sexual harassment				
	Organizational skills (such as planning, delegation, knowledge of key responsibility areas, goal setting, team building etc.)				
	Health and well-being, and stress management				
	Adaptation to new skills and methodologies				

Level of intervention as per competency need assessed

High	Moderate	Low
------	----------	-----

Training Need Assessment:

Type	Competency	Training Need Assessment
Domain	Policy / Rule drafting on toll domain	<ul style="list-style-type: none"> Trainings on policy formulation and drafting of rules. Intermediate to advanced level training curriculum to be designed for officers (up to SE level)
	Acts, Laws, rules, guidelines, notifications and amendments on matter related to land, user fee, toll collection etc.	<ul style="list-style-type: none"> Induction material for all officers Training to all officers (up to SE level)
	Preparation of or modification of User Fee (Toll) policies or regulations, according to Cabinet	<ul style="list-style-type: none"> Induction material for all officers Training to all officers (up to SE level)
	Managing complaints against user fees brought up by various transport organizations	<ul style="list-style-type: none"> Induction material for all officers Training to all officers (up to SE level)
	Managing user fee concerns with the NHAI, other departments, and state government	<ul style="list-style-type: none"> Induction material for all officers Training to all officers (up to SE level)
	Implementation of Toll Collection System	<ul style="list-style-type: none"> Advanced training to all officers
Functional	Central Portals (e-office, NIC Portal, Grievance Portal, VIP Portal, Bhoomirashi Portal and any other relevant portal)	<ul style="list-style-type: none"> Trainings on portals should be provided as part of induction/ refresher trainings to increase functional efficiency of the staff members.
	MS Office Skills (Word, PowerPoint, Excel)	<ul style="list-style-type: none"> Trainings on MS office should be provided for better documentation, report writing, data management etc. Advanced training to US and below. Refresher/ induction training should be provided for all new joiners.
	Government documentation (noting, drafting, cabinet notes, parliamentary answers, reports, Memorandum of Understanding etc.), reporting for parliamentary procedures, questions, and RTI queries	<ul style="list-style-type: none"> Trainings on Government documentation, protocols, processes, etc. should be provided to all staff members. Trainings to be provided to all officers in positions and refresher/ induction trainings to be conducted for new joiners.
	Financial procedures/ GFR/ Bill clearances/ PFMS	<ul style="list-style-type: none"> Basic knowledge of GFR/ Financial bills and operation of PFMS portal should be provided to all new joiners and other officers in position.
	GRM (Grievance Redressal Mechanism), CPGRAMs and INGRAMs Portals	<ul style="list-style-type: none"> Trainings on portals should be provided as part of induction/ refresher trainings to increase functional efficiency of the staff members.

	Government procurement protocols, processes, and tools (RFP, Tender Evaluation, Tender Award, Government e Marketplace - GeM) etc.)	<ul style="list-style-type: none"> • Trainings on Government documentation, protocols, processes, understanding of tender, GeM portals etc. should be provided to all staff members. • Trainings to be provided to all officers in positions and refresher/ induction trainings to be conducted for new joiners.
	Judicial Pronouncement and Restrictions, Audit Paras and Court Cases	<ul style="list-style-type: none"> • Basic trainings to handle matters related to court and other PMO related Q&A should be provided to all officers. • Trainings should be made mandatory.
Behavioural	Verbal communication; Liaisoning and Negotiation skills	<ul style="list-style-type: none"> • Effective communication plays a crucial role in handling day to day ministerial activities in both written and verbal form. It encourages effective dialogue. Negotiation, understanding on perspectives, building relationships and smooth transfer of knowledge. • Hence, communication trainings should be provided to all officer up to SE level.
	Multitasking and time management	<ul style="list-style-type: none"> • Trainings on multitasking and time management to be conducted for all officials to maintain healthy work life balance. • Advanced training for senior officers.
	Administrative and managerial skills	<ul style="list-style-type: none"> • To run an efficient team, training should be provided for enhancing the managerial skills of the section staff. It will increase the sense of decision making, communication, strategic planning etc. • Senior officials such as SE and above should be provided with advanced level trainings to upskill. • Induction / Refresher training to be provided for new joiners.
	Stakeholder and people management	<ul style="list-style-type: none"> • Trainings to handle and negotiate with stakeholders both internal and external shall be provided to the staffs for ease knowledge transfer through means of communication.
	Gender sensitization and anti-sexual harassment	<ul style="list-style-type: none"> • To promote inclusivity, enhance organizational culture, prevent harassment at workplace, regular trainings should be provided on sensitive topics such as sexual harassment. • Such interpersonal trainings should be conducted at regular intervals and these trainings should be mandatory for all designations.
	Organizational skills (such as planning, delegation, knowledge of key responsibility areas, goal setting, team building etc.)	<ul style="list-style-type: none"> • Regular upskilling required to enhance organizational skills for all employees (particularly senior officers) to delegate matters effectively,
	Health and well-being, and stress management	<ul style="list-style-type: none"> • Importance of proper healthy wellbeing should be taught to individuals. • Trainings on balancing health to be provided to officers of all level.
	Adaptation to new skills and methodologies	<ul style="list-style-type: none"> • Regular upskilling is essential to pace up with the existing technological advancements and hence trainings should be provided to all officials to increase adaptability to new technologies and their operating procedures.

2.6.2.6. International Cooperation (IC) Division

International Cooperation wing deals with matters related to international issues and tasks. It is headed by Additional Secretary, who is further supported by other subordinate staff for various administrative activities. Key officials are responsible to handle bilateral meetings, international stakeholders, meetings with delegates etc.

Figure 20: Organogram - IC Division

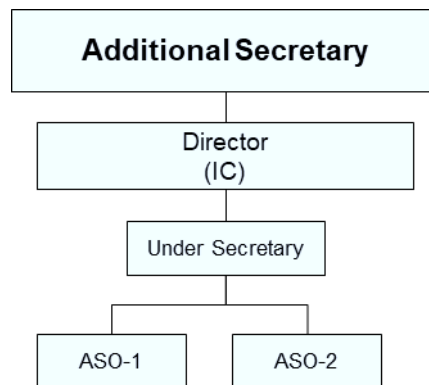

Key focus areas

- Bilateral relations
- MOUs
- Meetings with delegates
- New projects/ plans

Role of International Cooperation (IC) Division

- This division handles international cooperation in Highways Sector, International Road Cooperation, Road Transport.
- Examining offers and suggestions for bilateral collaboration, memorandums of understanding, and frameworks for cooperation with different nations.
- Participation in discussions and highway-related developments on behalf of India at international forums such as the South Asian Association for Regional Cooperation (SAARC), Bangladesh, Bhutan, India, and Nepal (BBIN), International Road Federation, International Transport Forum, World Economic Forum, and Forum of Asian Ministers of Transportation Asia-Pacific Ministerial Conference 2010, Asian Investment Conference 2010, and India 2nd World Bank-Singapore Infrastructure Financing Conference, Singapore Trade and Investment Forum, etc.
- Any issues involving United Nations Organizations, such as the World Trade Organization, the United Nations Development Program, and the United Nations Economic and Social Commission for Asia and the Pacific (UNESCAP),
- Preparing Minister (RT&H), MOS (RT&H), Secretary (RT&H), Additional Secretary, and Indian delegations led by them, Joint Secretary, and other officers for overseas visits

Roles and functions of various officer levels:

Designation	Role and functions
AS	<ul style="list-style-type: none"> ○ Routine Review of tasks

Designation	Role and functions
	<ul style="list-style-type: none"> ○ Formulating policies and strategies to enhance international cooperation projects. ○ Collaborating with foreign governments, international organizations ○ Handling stakeholders to foster international partnerships. ○ Participation in discussion of international forum ○ PMO meetings ○ Participating in international negotiations ○ Parliamentary matters
Director	<ul style="list-style-type: none"> ○ Facilitating the exchange of information and best practices ○ Assisting the AS in miscellaneous tasks ○ Working on matters related to monitoring and compliance. ○ Working on matters related to global collaboration and policy influence
US	<ul style="list-style-type: none"> ○ Handling administrative tasks, preparing documentation, and managing correspondence related to international cooperation initiatives. ○ Facilitating coordination between different departments ○ Handling communications with foreign embassies, international organizations, and stakeholders involved in international cooperation. ○ Assisting in the analysis of data or reports ○ Assisting in monitoring compliance with international agreements
ASO	<ul style="list-style-type: none"> ○ Providing administrative support ○ Handling coordination and communication ○ Assisting in organizing meetings, conferences, or seminars related to international cooperation initiatives. ○ Conducting research and gathering information on international policies ○ Providing support to higher-ranking officers in their day-to-day operational tasks related to international cooperation activities. ○ Assists in maintaining records and facilitating effective communication. ○ PMO references ○ Working on proposals ○ Public grievances and other Miscellaneous issues.

Based on the roles and functions, the domain competencies identified across various officer levels are:

Domain Competencies	AS	Director	US	ASO
Diplomacy and negotiation skills				
Policy development and analysis				
Strategic international planning and foreign management				
Cross function collaboration				
Knowledge of international forums				
Compliance and legal knowledge				
Knowledge of international agreements etc.				

Level of intervention as per competency need assessed

High	Moderate	Low
------	----------	-----

The behavioural and functional competencies mapped for the section are the follows:

Type	Competencies	AS	Director	US	ASO
Functional	Central Portals (e-office, NIC Portal, Grievance Portal, VIP Portal, Bhoomirashi Portal and any other relevant portal)				
	MS Office (Word, PowerPoint, Excel)				
	Government documentation (noting, drafting, cabinet notes, parliamentary answers, reports, Memorandum of Understanding etc.), reporting for parliamentary procedures, questions, and RTI queries				
	Financial procedures/ GFR/ Bill clearances/ PFMS				
	GRM (Grievance Redressal Mechanism), CPGRAMs and INGRAMs Portals				
	Government procurement protocols, processes, and tools (RFP, Tender Evaluation, Tender Award, Government e Marketplace - GeM) etc.)				
Behavioural	Verbal communication; Liaisoning and Negotiation skills				
	Multitasking and time management				
	Administrative and managerial skills				
	Stakeholder and people management				
	Gender sensitization and anti-sexual harassment				
	Organizational skills (such as planning, delegation, knowledge of key responsibility areas, goal setting, team building etc.)				
	Health and well-being, and stress management				
	Adaptation to new skills and methodologies				

Level of intervention as per competency need assessed

High	Moderate	Low
------	----------	-----

Training Need Assessment:

Type	Competency	Training Need Assessment
Domain	Diplomacy and negotiation skills	<ul style="list-style-type: none"> • Trainings on enhancing diplomacy skills to build rapport, build foreign relationships for senior officials US and above. • Basic refresher / induction training to be provided to officers below Director Level.
	Policy development and analysis	<ul style="list-style-type: none"> • Advanced training for policy analysis for officers (Director & US)
	Strategic international planning and foreign management	<ul style="list-style-type: none"> • Advanced training for policy analysis for officers (Director & US)

	Cross function collaboration	<ul style="list-style-type: none"> • Trainings on capability to work collaboratively with various departments within the ministry and other government bodies for aligned international strategies for officers (Up to director level).
	Knowledge of international forums	<ul style="list-style-type: none"> • Intermediate training to all officers.
	Compliance and legal knowledge	<ul style="list-style-type: none"> • Intermediate training to all officers.
	Knowledge of international agreements etc.	<ul style="list-style-type: none"> • Intermediate training to all officers.
Functional	Central Portals (e-office, NIC Portal, Grievance Portal, VIP Portal, Bhoomirashi Portal and any other relevant portal)	<ul style="list-style-type: none"> • Trainings on portals should be provided as part of induction/ refresher trainings to increase functional efficiency of the staff members.
	MS Office Skills (Word, PowerPoint, Excel)	<ul style="list-style-type: none"> • Trainings on MS office should be provided for better documentation, report writing, data management etc. • Advanced training to US and below. • Refresher/ induction training should be provided for all new joiners.
	Government documentation (noting, drafting, cabinet notes, parliamentary answers, reports, Memorandum of Understanding etc.), reporting for parliamentary procedures, questions, and RTI queries	<ul style="list-style-type: none"> • Trainings on Government documentation, protocols, processes, etc. should be provided to all staff members. • Trainings to be provided to all officers in positions and refresher/ induction trainings to be conducted for new joiners.
	Financial procedures/ GFR/ Bill clearances/ PFMS	<ul style="list-style-type: none"> • Basic knowledge of GFR/ Financial bills and operation of PFMS portal should be provided to all new joiners and other officers in position.
	GRM (Grievance Redressal Mechanism), CPGRAMs and INGRAMs Portals	<ul style="list-style-type: none"> • Trainings on portals should be provided as part of induction/ refresher trainings to increase functional efficiency of the staff members.
	Government procurement protocols, processes, and tools (RFP, Tender Evaluation, Tender Award, Government e Marketplace - GeM) etc.)	<ul style="list-style-type: none"> • Trainings on Government documentation, protocols, processes, understanding of tender, GeM portals etc. should be provided to all staff members. • Trainings to be provided to all officers in positions and refresher/ induction trainings to be conducted for new joiners.
Behavioural	Verbal communication; Liaisoning and Negotiation skills	<ul style="list-style-type: none"> • Effective communication plays a crucial role in handling day to day ministerial activities in both written and verbal form. It encourages effective dialogue. Negotiation, understanding on perspectives, building relationships and smooth transfer of knowledge. • Hence, communication trainings should be provided to all officer up to Director level.
	Multitasking and time management	<ul style="list-style-type: none"> • Trainings on multitasking and time management to be conducted for all officials to maintain healthy work life balance. • Advanced training for senior officers.
	Administrative and managerial skills	<ul style="list-style-type: none"> • To run an efficient team, training should be provided for enhancing the managerial skills of the section staff. It will increase the sense of decision making, communication, strategic planning etc. • Senior officials such as Director and above should be provided with advanced level trainings to upskill. • Induction / Refresher training to be provided for new joiners.
	Stakeholder and people management	<ul style="list-style-type: none"> • Trainings to handle and negotiate with stakeholders both internal and external shall be provided to the staffs for ease knowledge transfer through means of communication.

Gender sensitization and anti-sexual harassment	<ul style="list-style-type: none"> To promote inclusivity, enhance organizational culture, prevent harassment at workplace, regular trainings should be provided on sensitive topics such as sexual harassment. Such interpersonal trainings should be conducted at regular intervals and these trainings should be mandatory for all designations.
Organizational skills (such as planning, delegation, knowledge of key responsibility areas, goal setting, team building etc.)	<ul style="list-style-type: none"> Regular upskilling required to enhance organizational skills for all employees (particularly senior officers) to delegate matters effectively.
Health and well-being, and stress management	<ul style="list-style-type: none"> Importance of proper healthy wellbeing should be taught to individuals. Trainings on balancing health to be provided to officers of all level.
Adaptation to new skills and methodologies	<ul style="list-style-type: none"> Regular upskilling is essential to pace up with the existing technological advancements and hence trainings should be provided to all officials to increase adaptability to new technologies and their operating procedures.

2.6.2.7. Finance Wing

The Finance Wing is headed by the Additional Secretary & Financial Adviser (AS&FA) and is common to both the Ministry of Road Transport & Highways and the Ministry of Shipping; and renders financial advice on various matters. It also assists in planning, budgeting, monitoring and evaluation of schemes/programmes.

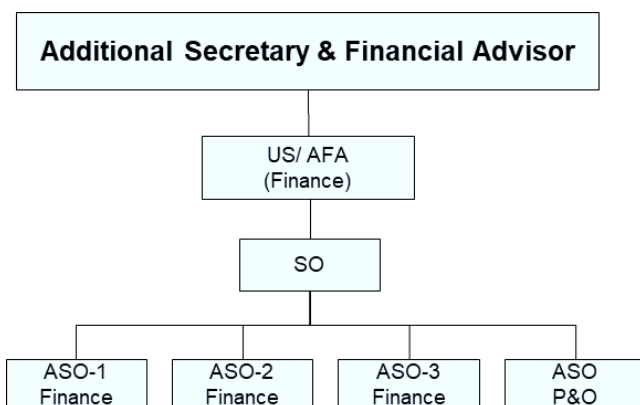

a) Finance and Budget Division

Figure 21: Organogram – Finance & Budget Division

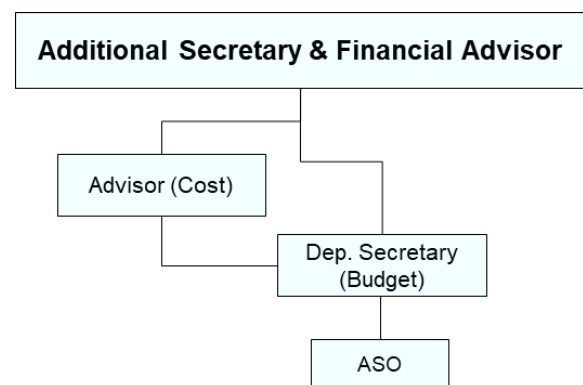

Key focus areas (Finance Division)

- Pay and revision of PayScale.
- Proposal handling
- Foreign exchange
- Investment proposals and grants

Role of Finance Division

- This division mainly handles matters related to Transport Finance.
- Proposals such as Investment proposals, grant assistance, purchase of machinery and equipment's, write off losses, vetting of amendments, approval of entertainment expenses, setting up various corporations, matters related to NHAI, release of funds etc. are all handled by finance division.

Key focus areas (Budget Division)

- Budget estimation
- Proposal management
- Fund management and allocation
- Coordination

Role of Budget Division

- This division handles the budget matters of MoRTH.
- Helps in BE/RE proposals from different administrative units and handles proposals of Budget estimates (BE) and Revised Estimates (RE)
- Prepares and issues statement of Budget Estimates to the Ministry of Finance
- Prepares detailed statements of approved estimates of administrative units.
- Collects materials and prepares Output Outcome Budget Framework
- Handles issuance of Fund Availability Certificates
- Prepares Notes on Demand for Grants for incorporation.
- Prepares Quarterly Report related to Government Guarantee and Outstanding and sends the same to Ministry of Finance for inclusion in Demands for Grants
- Manages coordination related to submission of ATRs.
- Prepares and Presents documents related to Six Months Statement to be made by Hon'ble Ministers of both the Ministries.
- Other works includes verification of accounts and setting up of the Standing Audit Committee for monitoring the status of furnishing of Action Taken Reports

Roles and functions of various officer levels:

Designation	Role and functions
AS & FA	<ul style="list-style-type: none"> ○ Oversee the financial planning and budgeting processes, ensuring alignment with organizational goals and priorities. ○ Provide expert financial advice to senior management on matters such as pay and revision of PayScale, foreign exchange, investment proposals, and grants. ○ Play a key role in the allocation of financial resources, including funds for various projects and initiatives. ○ Ensure compliance with financial regulations and guidelines, and conduct financial reviews to identify areas for improvement and efficiency. ○ Oversight on budget matters, including the preparation of Budget Estimates (BE) and Revised Estimates (RE), and the issuance of Fund Availability Certificates.
Advisor (Cost)	<ul style="list-style-type: none"> ○ Provide inputs in cost estimation for various projects and initiatives, contributing to the accuracy of budget estimate ○ Conduct detailed cost analysis to identify areas for cost savings and optimization. ○ Offer recommendations on cost-effective measures and financial strategies to enhance overall financial efficiency. ○ Contribute to the formulation of financial policies and guidelines, ensuring compliance with government regulations.

Designation	Role and functions
Deputy Secretary	<ul style="list-style-type: none"> Oversee the preparation and issuance of statements of Budget Estimates and detailed statements of approved estimates of administrative units. Prepare and submit Quarterly Reports related to Government Guarantee and Outstanding to the Ministry of Finance for inclusion in Demands for Grants. Collaborate with different administrative units to consolidate BE/RE proposals and ensure accurate and timely submission to the Ministry of Finance. Manage coordination related to the submission of Action Taken Reports and ensure timely follow-up on outstanding matters.
US/ AFA	<ul style="list-style-type: none"> Manage the processing and documentation of various proposals, including investment proposals, grant assistance, and other financial requests. Act as a liaison between different departments and stakeholders to gather information, address concerns, and facilitate smooth communication regarding financial matters. Maintain organized records of financial transactions, proposals, and other relevant documents.
SO/ ASO	<ul style="list-style-type: none"> Handle tasks related to the payment to contractors, revision of PayScale for employees. Review and vet proposed schemes, proposals, financial documents, ensuring accuracy and compliance with regulations. Provide administrative support for various financial processes, including the release of funds, purchase of machinery and equipment, and handling entertainment expenses. Prepare and maintain detailed documentation of financial transactions and generate reports as needed. Verify financial accounts and contribute to the setting up of the Standing Audit Committee for monitoring the status of furnishing of Action Taken Reports.

Based on the roles and functions, the domain competencies identified across various officer levels are:

Domain Competencies	AS&FA	Advisor (Cost)	DS	US/ AFA	SO	ASO
Financial Planning						
Budgeting						
Treasury						
Cash Management						
Accounting and Accounting Standards						
Delegation of Financial Power Rules (DFPR), an indicator of overall expanse of duties and responsibilities of Financial Advisor						
Manage BE/RE proposals from different administrative units						
FRBM Act, presenting disclosure statements against parliament, this would include collection of requisite information and material inputs from FMs to understand fiscal situation						
Financial management which includes schematic appraisal and concept functions, revenue management, fiscal						

Domain Competencies	AS&FA	Advisor (Cost)	DS	US/ AFA	SO	ASO
resource transfer issues etc.						

Level of intervention as per competency need assessed

High	Moderate	Low
------	----------	-----

The behavioural and functional competencies mapped for the section are the follows:

Type	Competencies	AS&FA	Advisor (Cost)	DS	US/ AFA	SO	ASO
Functional	Central Portals (e-office, NIC Portal, Grievance Portal, VIP Portal, Bhoomirashi Portal and any other relevant portal)						
	MS Office (Word, PowerPoint, Excel)						
	Government documentation (noting, drafting, cabinet notes, parliamentary answers, reports, Memorandum of Understanding etc.), reporting for parliamentary procedures, questions, and RTI queries						
	Financial procedures/ GFR/ Bill clearances/ PFMS						
	GRM (Grievance Redressal Mechanism), CPGRAMs and INGRAMs Portals						
	Government procurement protocols, processes, and tools (RFP, Tender Evaluation, Tender Award, Government e Marketplace - GeM) etc.)						
	Behavioural	Verbal communication; Liaisoning and Negotiation skills					
Multitasking and time management							
Administrative and managerial skills							
Stakeholder and people management							
Gender sensitization and anti-sexual harassment							
Organizational skills (such as planning, delegation, knowledge of key responsibility areas, goal setting, team building etc.)							
Health and well-being, and stress management							
Adaptation to new skills and methodologies							

Level of intervention as per competency need assessed

High	Moderate	Low
------	----------	-----

Training Need Assessment:

Type	Competency	Training Need Assessment
Domain	Financial Planning	<ul style="list-style-type: none"> Training to be provided on financial planning practices
	Budgeting	<ul style="list-style-type: none"> New joiners should be given refresher/ induction training on budgeting. Trainings on project budgeting to be provided to senior officials.
	Treasury	<ul style="list-style-type: none"> Refresher/ induction training on treasury to be provided to new joiners and senior officers in position.
	Cash Management	<ul style="list-style-type: none"> Trainings on cash management to be provided for better utilisation of funds, etc.
	Accounting and Accounting Standards	<ul style="list-style-type: none"> Basic level training on accounting and accounting standards for new joiners should also be conducted.
	Delegation of Financial Power Rules (DFPR), an indicator of overall expanse of duties and responsibilities of Financial Advisor	<ul style="list-style-type: none"> Intermediate to advanced level training on DFPR rules for all officers in position
	Manage BE/RE proposals from different administrative units	<ul style="list-style-type: none"> Trainings on managing BE/RE proposals to be provided for senior officials etc.
	FRBM Act, presenting disclosure statements against parliament, this would include collection of requisite information and material inputs from FMs to understand fiscal situation	<ul style="list-style-type: none"> New joiners should be given refresher/ induction training on FRBM Act. Advanced Trainings on FRBM Act to be provided to senior officials.
	Financial management which includes schematic appraisal and concept functions, revenue management, fiscal resource transfer issues etc.	<ul style="list-style-type: none"> Trainings on financial management to be provided for better revenue management etc. to senior officials for effective decision making.
Functional	Central Portals (e-office, NIC Portal, Grievance Portal, VIP Portal, Bhoomirashi Portal and any other relevant portal)	<ul style="list-style-type: none"> Trainings on portals should be provided as part of induction/ refresher trainings to increase functional efficiency of the staff members.
	MS Office Skills (Word, PowerPoint, Excel)	<ul style="list-style-type: none"> Trainings on MS office should be provided for better documentation, report writing, data management etc. Advanced training to US and below. Refresher/ induction training should be provided for all new joiners.
	Government documentation (noting, drafting, cabinet notes, parliamentary answers, reports, Memorandum of Understanding etc.), reporting for parliamentary procedures, questions, and RTI queries	<ul style="list-style-type: none"> Trainings on Government documentation, protocols, processes, etc. should be provided to all staff members. Trainings to be provided to all officers in positions and refresher/ induction trainings to be conducted for new joiners.
	Financial procedures/ GFR/ Bill clearances/ PFMS	<ul style="list-style-type: none"> Basic knowledge of GFR/ Financial bills and operation of PFMS portal should be provided to all new joiners and other officers in position.
	GRM (Grievance Redressal Mechanism), CPGRAMs and INGRAMs Portals	<ul style="list-style-type: none"> Trainings on portals should be provided as part of induction/ refresher trainings to increase functional efficiency of the staff members.
	Government procurement protocols, processes, and tools (RFP, Tender Evaluation, Tender Award, Government e Marketplace - GeM) etc.)	<ul style="list-style-type: none"> Trainings on Government documentation, protocols, processes, understanding of tender, GeM portals etc. should be provided to all staff members. Trainings to be provided to all officers in positions and refresher/ induction trainings to be conducted for new joiners.
Behavioral	Verbal communication; Liaisoning and Negotiation skills	<ul style="list-style-type: none"> Effective communication plays a crucial role in handling day to day ministerial activities in both written and verbal form. It encourages effective dialogue. Negotiation, understanding on

	<p>perspectives, building relationships and smooth transfer of knowledge.</p> <ul style="list-style-type: none"> Hence, communication trainings should be provided to all officer up to DS level.
Multitasking and time management	<ul style="list-style-type: none"> Trainings on multitasking and time management to be conducted for all officials to maintain healthy work life balance. Advanced training for senior officers.
Administrative and managerial skills	<ul style="list-style-type: none"> To run an efficient team, training should be provided for enhancing the managerial skills of the section staff. It will increase the sense of decision making, communication, strategic planning etc. Senior officials such as Director and above should be provided with advanced level trainings to upskill. Induction / Refresher training to be provided for new joiners.
Stakeholder and people management	<ul style="list-style-type: none"> Trainings to handle and negotiate with stakeholders both internal and external shall be provided to the staffs for ease knowledge transfer through means of communication.
Gender sensitization and anti-sexual harassment	<ul style="list-style-type: none"> To promote inclusivity, enhance organizational culture, prevent harassment at workplace, regular trainings should be provided on sensitive topics such as sexual harassment. Such interpersonal trainings should be conducted at regular intervals and these trainings should be mandatory for all designations.
Organizational skills (such as planning, delegation, knowledge of key responsibility areas, goal setting, team building etc.)	<ul style="list-style-type: none"> Regular upskilling required to enhance organizational skills for all employees (particularly senior officers) to delegate matters effectively,
Health and well-being, and stress management	<ul style="list-style-type: none"> Importance of proper healthy wellbeing should be taught to individuals. Trainings on balancing health to be provided to officers of all level.
Adaptation to new skills and methodologies	<ul style="list-style-type: none"> Regular upskilling is essential to pace up with the existing technological advancements and hence trainings should be provided to all officials to increase adaptability to new technologies and their operating procedures.

2.6.2.8. Administration Wing

a) Establishment-I (E-I) Section

Figure 22: Organogram - E-I Division

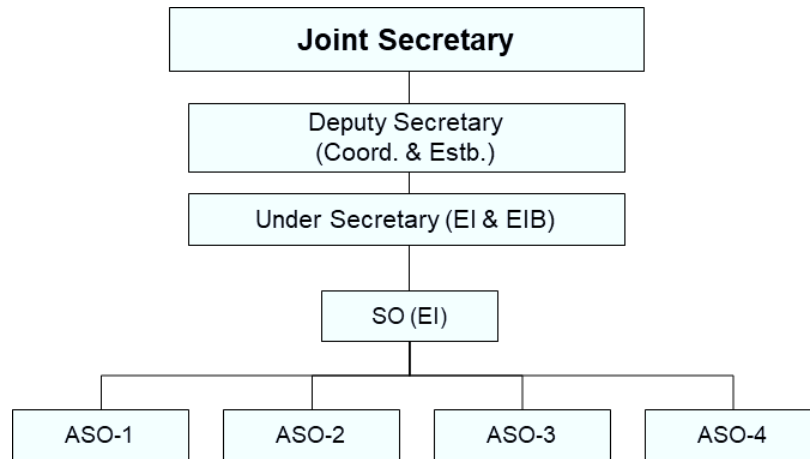

Key focus areas

- All administrative matters of all Officers and Staff of this Ministry including staff of Hon'ble Minister and Hon'ble Minister of State but excluding CSSS and MTS

Role of Establishment-I (E-I) Section

- All service matters of officers/officials of MoRTH including personal staff of Hon'ble Minister and TRW
- Matters pertaining to grant of permission for medical treatment/investigations from recognised CGHS hospitals/Centres, re-imburement of medical claims, medical advances credit facilities, appointment of Authorised Medical Attendants in respect of the above categories of Officers/Officials.
- Compilation of Annual immovable property Returns in respect of Group-A and Group-B officers of the above mentioned categories of officers/Officials.
- All court cases/disciplinary cases under CCS(Conduct) Rules in respect of above mentioned categories of the officers and officials.
- Monthly return to Cabinet Secretary regarding status of vacancies and proposals in the PSUs/Banks/Autonomous Bodies/ DPC Selections, etc.
- Furnishing of information under RTI Act in respect of above mentioned posts/category of officers/officials.
- Preparation and furnishing of periodical returns/reports to the concerned Sections/Organizations in respect of the above mentioned category of officers/ officials.
- Grant of honorarium to all categories of officers/officials of the Ministry of Road Transport & Highways.
- Forwarding of applications for allotment of Government Accommodations and other related matters to Directorate of Estates
- Alleviation in respect of all categories of Officers/Officials of the Ministry of Road Transport & Highways

Roles and functions of various officer levels:

Designation	Role and functions
-------------	--------------------

Designation	Role and functions
Joint Secretary	<ul style="list-style-type: none"> ○ Routine Review of tasks and assigning work to lower-level officers. ○ Working on strengthening policy measures for efficient internal management ○ Managing status of vacancy and proposal ○ PMO matters. ○ Parliamentary Q& A ○ Stakeholder management both national / international ○ Monitoring and supervision of the section ○ Taking important budgetary decisions for the section
Deputy Secretary (DS)	<ul style="list-style-type: none"> ○ Managing databases of the employee with assistance from lower staffs ○ Facilitating administration coordination and collaboration ○ Handling matters related to establishment 1 ○ Onboarding of officers and details of their service ○ PMO matters. ○ Grievance handling
Under Secretary (US)	<ul style="list-style-type: none"> ○ Supporting in administrative tasks in preparing documentation ○ managing correspondence related to administrative policies initiatives. ○ Facilitating coordination between different departments ○ Handling communications with other sections
Section Officer (SO)/ Assistant Section Officer (ASO)	<ul style="list-style-type: none"> ○ Handle routine administrative tasks related to the EI Section. ○ Maintain records and documentation related to Officers and Staff of this Ministry ○ Collating and furnishing of information under RTI Act ○ Other miscellaneous tasks assigned by senior officers.

Based on the roles and functions, the domain competencies identified across various officer levels are:

Domain Competencies	JS	DS	US	SO/ ASO
Understanding of all service matters of officers/officials of MoRTH				
Awareness of matters pertaining to grant of permission for medical treatment/investigations from recognised CGHS hospitals/Centres, etc. for government officials				
Awareness of CSS rules to handle disciplinary matters				
Managing applications for government accommodations, travels etc.				
Knowledge of Compilation of Annual immovable property Returns				
Awareness of CSMOP manual				

Level of intervention as per competency need assessed

High	Moderate	Low
------	----------	-----

The behavioural and functional competencies mapped for the section are the follows:

Type	Competencies	JS	DS	US	SO/ ASO
Functional	Central Portals (e-office, NIC Portal, Grievance Portal, VIP Portal, Bhoomirashi Portal and any other relevant portal)	Low	Moderate	Moderate	High
	MS Office (Word, PowerPoint, Excel)	Moderate	Moderate	High	High
	Government documentation (noting, drafting, cabinet notes, parliamentary answers, reports, Memorandum of Understanding etc.), reporting for parliamentary procedures, questions, and RTI queries	Low	Moderate	Moderate	High
	Financial procedures/ GFR/ Bill clearances/ PFMS	Low	Moderate	Moderate	High
	GRM (Grievance Redressal Mechanism), CPGRAMs and INGRAMs Portals	Low	Moderate	High	High
	Government procurement protocols, processes, and tools (RFP, Tender Evaluation, Tender Award, Government e Marketplace - GeM) etc.)	Moderate	Moderate	Moderate	High
Behavioural	Verbal communication; Liaisoning and Negotiation skills	Low	Moderate	Moderate	High
	Multitasking and time management	Moderate	Moderate	Low	Low
	Administrative and managerial skills	Moderate	Moderate	Low	High
	Stakeholder and people management	Low	Moderate	Moderate	High
	Gender sensitization and anti-sexual harassment	Moderate	Moderate	Moderate	Moderate
	Organizational skills (such as planning, delegation, knowledge of key responsibility areas, goal setting, team building etc.)	Low	Low	Moderate	High
	Health and well-being, and stress management	High	High	Moderate	Moderate
	Adaptation to new skills and methodologies	High	High	High	High

Level of intervention as per competency need assessed

High	Moderate	Low
------	----------	-----

Training Need Assessment:

Type	Competency	Training Need Assessment
Domain	Understanding of all service matters of officers/officials of MoRTH	<ul style="list-style-type: none"> Induction material to all staff
	Awareness of matters pertaining to grant of permission for medical treatment/investigations from recognised CGHS hospitals/Centres, etc. for government officials	<ul style="list-style-type: none"> Basic training to US and below
	Awareness of CSS rules to handle disciplinary matters	<ul style="list-style-type: none"> Basic training to US and below
	Managing applications for government accommodations, travels etc.	<ul style="list-style-type: none"> Induction material to all staff
	Knowledge of Compilation of Annual immovable property Returns	<ul style="list-style-type: none"> Induction material to all staff
	Awareness of CSMOP manual	<ul style="list-style-type: none"> Induction material to all staff

Functional	Central Portals (e-office, NIC Portal, Grievance Portal, VIP Portal, Bhoomirashi Portal and any other relevant portal)	<ul style="list-style-type: none"> • Trainings on portals should be provided as part of induction/ refresher trainings to increase functional efficiency of the staff members.
	MS Office Skills (Word, PowerPoint, Excel)	<ul style="list-style-type: none"> • Trainings on MS office should be provided for better documentation, report writing, data management etc. • Advanced training to US and below. • Refresher/ induction training should be provided for all new joiners.
	Government documentation (noting, drafting, cabinet notes, parliamentary answers, reports, Memorandum of Understanding etc.), reporting for parliamentary procedures, questions, and RTI queries	<ul style="list-style-type: none"> • Trainings on Government documentation, protocols, processes, etc. should be provided to all staff members. • Trainings to be provided to all officers in positions and refresher/ induction trainings to be conducted for new joiners.
	Financial procedures/ GFR/ Bill clearances/ PFMS	<ul style="list-style-type: none"> • Basic knowledge of GFR/ Financial bills and operation of PFMS portal should be provided to all new joiners and other officers in position.
	GRM (Grievance Redressal Mechanism), CPGRAMs and INGRAMs Portals	<ul style="list-style-type: none"> • Trainings on portals should be provided as part of induction/ refresher trainings to increase functional efficiency of the staff members.
	Government procurement protocols, processes, and tools (RFP, Tender Evaluation, Tender Award, Government e Marketplace - GeM) etc.)	<ul style="list-style-type: none"> • Trainings on Government documentation, protocols, processes, understanding of tender, GeM portals etc. should be provided to all staff members. • Trainings to be provided to all officers in positions and refresher/ induction trainings to be conducted for new joiners.
Behavioural	Verbal communication; Liaisoning and Negotiation skills	<ul style="list-style-type: none"> • Communication trainings should be provided to all officer up to DS level.
	Multitasking and time management	<ul style="list-style-type: none"> • Trainings on multitasking and time management to be conducted for all officials to maintain healthy work life balance. • Advanced training for senior officers.
	Administrative and managerial skills	<ul style="list-style-type: none"> • Senior officials such as DS and above should be provided with advanced level trainings to upskill. • Induction / Refresher training to be provided for new joiners.
	Stakeholder and people management	<ul style="list-style-type: none"> • Trainings to handle and negotiate with stakeholders both internal and external shall be provided to the staffs for ease knowledge transfer through means of communication.
	Gender sensitization and anti-sexual harassment	<ul style="list-style-type: none"> • Such interpersonal trainings should be conducted at regular intervals and these trainings should be mandatory for all designations.
	Organizational skills (such as planning, delegation, knowledge of key responsibility areas, goal setting, team building etc.)	<ul style="list-style-type: none"> • Regular upskilling required to enhance organizational skills for all employees (particularly senior officers) to delegate matters effectively.
	Health and well-being, and stress management	<ul style="list-style-type: none"> • Trainings on balancing health to be provided to officers of all level.
	Adaptation to new skills and methodologies	<ul style="list-style-type: none"> • Regular upskilling is essential to pace up with the existing technological advancements and hence trainings should be provided to all officials to increase adaptability to new technologies and their operating procedures.

a. Establishment-IB (E-IB) Section

Figure 23: Organogram - EIB Division

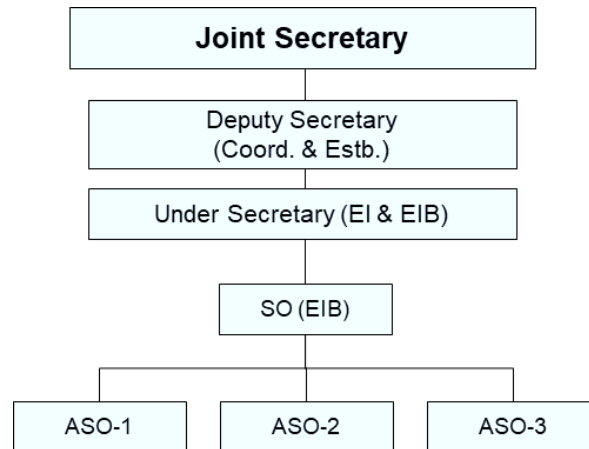

Key focus areas

- All administrative matter of all process of CSSS and MTS,
- Maintenance of Annual Performance Appraisal Reports (APARs) and Annual Immovable Property Returns (AIPRs) of all Officers and Staff

Role of Establishment-IB (E-IB) Section

- ACR Cell as part of EI(B) Section:- Maintenance and custody of APARs in respect of all the non-technical Officers and staff.
- All administrative and service matters in respect of CSSS cadre officers/officials.
- All administrative and service matters in respect of erstwhile Group 'D' officials (now Group C- Multi-Tasking Staff).
- Deployment of Multi-Tasking staff with the officers/Sections including TR Wing.
- All work relating to internal coordination among Establishment/Administration Sections.
- Budget-related work in respect of Administration Wing.
- All matters relating to Election Duty as required by the Election Commission/Office of the Chief Electoral Officer, Delhi except appointment of 'Observers'.
- Sending nominations for deployment of invigilators/Supervisors for the conduct of UPSC/SSC/other Organisations' Competitive examinations like Civil Services Examination, etc.
- Review of Service under FR 56(j), Rule 48 of CSS (Pension) Rules in respect of Officers and Staff members of MoRT&H, whose administrative matters are dealt with in EI, EI(B), Canteen & General Section.
- Submission of Quarterly return to vigilance Section regarding review of Service cases under FR 56(j)/complaint against CSSS Grade Officers (PSO, Sr. PPS/PPS level)/ Property return of CSSS officers and other categories administratively handled in the Section.
- Coordination, monitoring and follow up action on reports of local/internal audit conducted by office of Principal CCA/CCA.

Roles and functions of various officer levels:

Designation	Role and functions
-------------	--------------------

Designation	Role and functions
Joint Secretary	<ul style="list-style-type: none"> ○ Handling matters related to ACR cells. ○ custody of Annual Performance Appraisal Reports (APARs) for non-technical Officers and staff ○ Handling administrative matters for Central Secretariat Service (CSSS) cadre. ○ Managing deployment of officers ○ Parliamentary matters and PMO meetings ○ Taking decisions on budget related tasks and finances
Deputy Secretary (DS)	<ul style="list-style-type: none"> ○ Maintenance and custody of APARs ○ Handling administrative and service-related matters for CSS officers ○ Matters related to government duties for election. ○ Assisting the JS in miscellaneous tasks ○ Providing quarterly updates on audit and vigilance matters ○ Working on matters related to monitoring and compliance. ○ Working on matters related to global collaboration and policy influence
Under Secretary (US)	<ul style="list-style-type: none"> ○ Handling administrative tasks, preparing documentation. ○ Assisting in the review of Service under FR 56(j), Rule 48 of CSS (Pension) Rules for Officers ○ Supporting coordination, monitoring, and follow-up action on reports of local/internal audits conducted by the Office of Principal CCA/CCA. ○ Facilitating coordination between different departments ○ Assisting in the analysis of data or reports
Section Officer (SO)/ Assistant Section Officer (ASO)	<ul style="list-style-type: none"> ○ Providing additional support to senior officers ○ Assisting in managing ACR cell and record management for the section ○ Managing exchange of information within the sections ○ Initiation of files ○ Review of proposals ○ Matters related to CSS officers. ○ Grievances management

Based on the roles and functions, the domain competencies identified across various officer levels are:

Domain Competencies	JS	DS	US	SO/ ASO
Knowledge of maintenance of APAR reports for the officials				
Awareness of administrative and service matters of the Group D officials				
Awareness of deployment of lower-level staff with the senior officers				
Rules for deployment of invigilation duties for government activities such as competitive exams etc.				
Awareness of CSMOP manual				
Awareness of rules of internal audit for managing audit matters				

Level of intervention as per competency need assessed

High	Moderate	Low
------	----------	-----

The behavioural and functional competencies mapped for the section are the follows:

Type	Competencies	JS	DS	US	SO/ ASO
Functional	Central Portals (e-office, NIC Portal, Grievance Portal, VIP Portal, Bhoomirashi Portal and any other relevant portal)	Low	Moderate	Moderate	High
	MS Office (Word, PowerPoint, Excel)	Moderate	Moderate	High	High
	Government documentation (noting, drafting, cabinet notes, parliamentary answers, reports, Memorandum of Understanding etc.), reporting for parliamentary procedures, questions, and RTI queries	Low	Moderate	Moderate	High
	Financial procedures/ GFR/ Bill clearances/ PFMS	Low	Moderate	Moderate	High
	GRM (Grievance Redressal Mechanism), CPGRAMs and INGRAMs Portals	Low	Moderate	High	High
	Government procurement protocols, processes, and tools (RFP, Tender Evaluation, Tender Award, Government e Marketplace - GeM) etc.)	Moderate	Moderate	Moderate	High
Behavioural	Verbal communication; Liaisoning and Negotiation skills	Low	Moderate	Moderate	High
	Multitasking and time management	Moderate	Moderate	Low	Low
	Administrative and managerial skills	Moderate	Moderate	Low	High
	Stakeholder and people management	Low	Moderate	Moderate	High
	Gender sensitization and anti-sexual harassment	Moderate	Moderate	Moderate	Moderate
	Organizational skills (such as planning, delegation, knowledge of key responsibility areas, goal setting, team building etc.)	Low	Low	Moderate	High
	Health and well-being, and stress management	High	High	Moderate	Moderate
	Adaptation to new skills and methodologies	High	High	High	High

Level of intervention as per competency need assessed

High	Moderate	Low
------	----------	-----

Training Need Assessment:

Type	Competency	Training Need Assessment
Domain	Knowledge of maintenance of APAR reports for the officials	<ul style="list-style-type: none"> Basic training (US & below)
	Awareness of administrative and service matters of the Group D officials	<ul style="list-style-type: none"> Basic training (US & below)
	Awareness of deployment of lower-level staff with the senior officers	<ul style="list-style-type: none"> Induction material to all staff

	Rules for deployment of invigilation duties for government activities such as competitive exams etc.	<ul style="list-style-type: none"> • Induction material to all staff
	Awareness of CSMOP manual	<ul style="list-style-type: none"> • Induction material to all staff
	Awareness of rules of internal audit for managing audit matters	<ul style="list-style-type: none"> • Induction material to all staff
Functional	Central Portals (e-office, NIC Portal, Grievance Portal, VIP Portal, Bhoomirashi Portal and any other relevant portal)	<ul style="list-style-type: none"> • Trainings on portals should be provided as part of induction/ refresher trainings to increase functional efficiency of the staff members.
	MS Office Skills (Word, PowerPoint, Excel)	<ul style="list-style-type: none"> • Trainings on MS office should be provided for better documentation, report writing, data management etc. • Advanced training to US and below. • Refresher/ induction training should be provided for all new joiners.
	Government documentation (noting, drafting, cabinet notes, parliamentary answers, reports, Memorandum of Understanding etc.), reporting for parliamentary procedures, questions, and RTI queries	<ul style="list-style-type: none"> • Trainings on Government documentation, protocols, processes, etc. should be provided to all staff members. • Trainings to be provided to all officers in positions and refresher/ induction trainings to be conducted for new joiners.
	Financial procedures/ GFR/ Bill clearances/ PFMS	<ul style="list-style-type: none"> • Basic knowledge of GFR/ Financial bills and operation of PFMS portal should be provided to all new joiners and other officers in position.
	GRM (Grievance Redressal Mechanism), CPGRAMs and INGRAMs Portals	<ul style="list-style-type: none"> • Trainings on portals should be provided as part of induction/ refresher trainings to increase functional efficiency of the staff members.
	Government procurement protocols, processes, and tools (RFP, Tender Evaluation, Tender Award, Government e Marketplace - GeM) etc.)	<ul style="list-style-type: none"> • Trainings on Government documentation, protocols, processes, understanding of tender, GeM portals etc. should be provided to all staff members. • Trainings to be provided to all officers in positions and refresher/ induction trainings to be conducted for new joiners.
Behavioural	Verbal communication; Liaisoning and Negotiation skills	<ul style="list-style-type: none"> • Communication trainings should be provided to all officer up to DS level.
	Multitasking and time management	<ul style="list-style-type: none"> • Trainings on multitasking and time management to be conducted for all officials to maintain healthy work life balance. • Advanced training for senior officers.
	Administrative and managerial skills	<ul style="list-style-type: none"> • Senior officials such as DS and above should be provided with advanced level trainings to upskill. • Induction / Refresher training to be provided for new joiners.
	Stakeholder and people management	<ul style="list-style-type: none"> • Trainings to handle and negotiate with stakeholders both internal and external shall be provided to the staffs for ease knowledge transfer through means of communication.
	Gender sensitization and anti-sexual harassment	<ul style="list-style-type: none"> • Such interpersonal trainings should be conducted at regular intervals and these trainings should be mandatory for all designations.
	Organizational skills (such as planning, delegation, knowledge of key responsibility areas, goal setting, team building etc.)	<ul style="list-style-type: none"> • Regular upskilling required to enhance organizational skills for all employees (particularly senior officers) to delegate matters effectively,
	Health and well-being, and stress management	<ul style="list-style-type: none"> • Trainings on balancing health to be provided to officers of all level.
	Adaptation to new skills and methodologies	<ul style="list-style-type: none"> • Regular upskilling is essential to pace up with the existing technological advancements and hence trainings should be

		provided to all officials to increase adaptability to new technologies and their operating procedures.
--	--	--

b) Establishment-II (E-II) Section

Figure 24: Organogram - EII Division

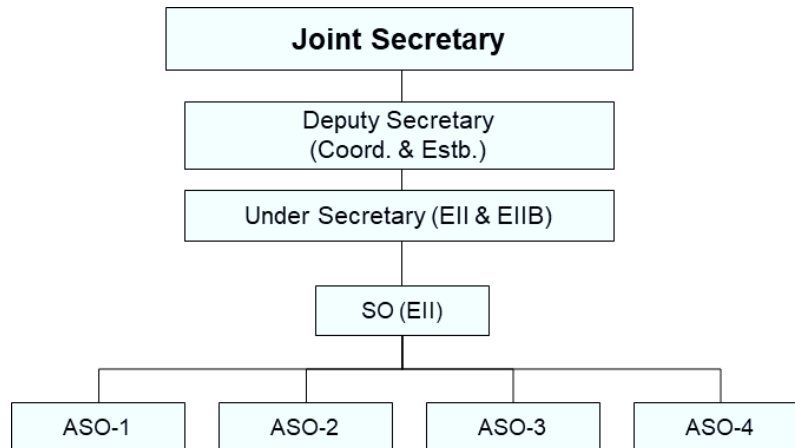

Key focus areas

- All matters related to Officers of Central Engineering Services (Roads) [CES(Roads)]

Role of Establishment-II (E-II) Section

- Cadre administration and establishment matter of Group "A" Technical Officers of Central Engineering Service (Road) and Group "C" & "D" employees posted at various Regional Offices/Engineering Liaison Offices of the Ministry of Road Transport and Highways which includes preparation & maintenance of Service records/service books/increments/Annual Service verification/Seniority Lists/work relating to confirmation and resignation, Annual Property Returns, maintenance of APARs, deputation, transfer etc. of these categories of staff/officers.
- Intimation of vacancies to UPSC/Regional SSC for filing up on direct recruitment basis.
- Framing/Amendments of Recruitment rules for the Central engineering Service (Roads) Group "A" and General Central Service Group "B" "C" and "D" posts.
- Work relating to medical claims for reimbursement, including appointment of AMAs, medical advances, tuition fee reimbursement, leave salary advance, all kinds of leave of all Gazetted technical officers and non-technical staff of ROs, verification of LTC claims and other advances in respect of the above mentioned officers and staff, verification of DE-II forms for Government accommodation.
- Preparation of various reports/furnishing information to various Sections of the Ministry.
- Review of service under FR 56 (i) and Rule 48 of CCS Pension Rules in respect of above categories of staff/Officers.
- Disciplinary action under CCS (conduct) Rules/CCS (CCA) Rules/court cases on various service matters in respect of above officers/staff.
- Declaration of DDO/HID in various ROs/ELOs of the ministry.
- Delegation of Financial Powers to the ROs/ELOs.
- All Training programmes involving participation of the officers and staff of this Ministry including its regional offices, autonomous bodies/societies/associate offices under the administrative purview of the Section. Formulation of Annual Training Plan, calling for applications, consultations with technical wings, processing of cases for nominations taking into account career profile and other administrative aspects.

Roles and functions of various officer levels:

Designation	Role and functions
Joint Secretary	<ul style="list-style-type: none"> Oversees the cadre administration and establishment matters of Group "A" Technical Officers of the Central Engineering Service (Road) and Group "C" & "D" employees posted at various Regional Offices/Engineering Liaison Offices. Frames and amends recruitment rules for the Central Engineering Service (Roads) Group "A" and General Central Service Group "B," "C," and "D" posts. Manages disciplinary actions under CCS (Conduct) Rules, CCS (CCA) Rules, and court cases related to service matters for officers and staff under the purview of the section.
Deputy Secretary (DS)	<ul style="list-style-type: none"> Communicates information on vacancies to the Union Public Service Commission (UPSC) and Regional Staff Selection Commission (SSC) for direct recruitment purposes. Manages medical claims for reimbursement, including the appointment of Authorized Medical Attendants (AMAs), medical advances, tuition fee reimbursement, and verification of LTC claims. Delegates financial powers to the Regional Offices/Engineering Liaison Offices (ROs/ELOs) and ensures their proper utilization.
Under Secretary (US)	<ul style="list-style-type: none"> Handles the preparation and maintenance of service records, service books, increments, annual service verification, seniority lists, confirmation, and resignation for Group "A" Technical Officers and Group "C" & "D" employees. Prepares various reports and furnishes information to various sections of the Ministry as required. Coordinates training programs involving officers and staff of the Ministry, its regional offices, autonomous bodies, societies, and associate offices, including the formulation of the Annual Training Plan.
Section Officer (SO)/ Assistant Section Officer (ASO)	<ul style="list-style-type: none"> Manages all kinds of leave for Gazetted technical officers and non-technical staff of Regional Offices, including verification of LTC claims and other advances. Assists in the declaration of Drawing and Disbursing Officers (DDOs) and Head of Office (HID) in various Regional Offices/Engineering Liaison Offices. Coordinates the review of service under FR 56 (i) and Rule 48 of CCS Pension Rules for the relevant categories of staff and officers.

Based on the roles and functions, the domain competencies identified across various officer levels are:

Domain Competencies	JS	DS	US	SO/ ASO
Awareness of CCS (conduct) Rules/CCS (CCA) Rules/court cases				
Awareness of Recruitment rules for the Central engineering Service (Roads) Group "A" and General Central Service Group "B" "C" and "D" posts.				
Knowledge of FR 56 (i) and Rule 48 of CCS Pension Rules				
Awareness of Delegation of Financial Powers to the ROs/ELOs.				
Formulation of the annual training plans				
Awareness of APAR, deputation matters and transfers				

Level of intervention as per competency need assessed

High	Moderate	Low
------	----------	-----

The behavioural and functional competencies mapped for the section are the follows:

Type	Competencies	JS	DS	US	SO/ ASO
Functional	Central Portals (e-office, NIC Portal, Grievance Portal, VIP Portal, Bhoomirashi Portal and any other relevant portal)	Low	Moderate	Moderate	High
	MS Office (Word, PowerPoint, Excel)	Moderate	Moderate	High	High
	Government documentation (noting, drafting, cabinet notes, parliamentary answers, reports, Memorandum of Understanding etc.), reporting for parliamentary procedures, questions, and RTI queries	Low	Moderate	Moderate	High
	Financial procedures/ GFR/ Bill clearances/ PFMS	Low	Moderate	Moderate	High
	GRM (Grievance Redressal Mechanism), CPGRAMs and INGRAMs Portals	Low	Moderate	High	High
	Government procurement protocols, processes, and tools (RFP, Tender Evaluation, Tender Award, Government e Marketplace - GeM) etc.)	Moderate	Moderate	Moderate	High
Behavioural	Verbal communication; Liaisoning and Negotiation skills	Low	Moderate	Moderate	High
	Multitasking and time management	Moderate	Moderate	Low	Low
	Administrative and managerial skills	Moderate	Moderate	Low	High
	Stakeholder and people management	Low	Moderate	Moderate	High
	Gender sensitization and anti-sexual harassment	Moderate	Moderate	Moderate	Moderate
	Organizational skills (such as planning, delegation, knowledge of key responsibility areas, goal setting, team building etc.)	Low	Low	Moderate	High
	Health and well-being, and stress management	High	High	Moderate	Moderate
	Adaptation to new skills and methodologies	High	High	High	High

Level of intervention as per competency need assessed

High	Moderate	Low
------	----------	-----

Training Need Assessment:

Type	Competency	Training Need Assessment
Domain	Awareness of CCS (conduct) Rules/CCS (CCA) Rules/court cases	<ul style="list-style-type: none"> Basic training to US & below
	Awareness of Recruitment rules for the Central engineering Service (Roads) Group "A" and General Central Service Group "B" "C" and "D" posts.	<ul style="list-style-type: none"> Basic training to US & below
	Knowledge of FR 56 (i) and Rule 48 of CCS Pension Rules	<ul style="list-style-type: none"> Induction material to all staff

	Awareness of Delegation of Financial Powers to the ROs/ELOs.	<ul style="list-style-type: none"> • Induction material to all staff
	Formulation of the annual training plans	<ul style="list-style-type: none"> • Training to staff (DS & below)
	Awareness of APAR, deputation matters and transfers	<ul style="list-style-type: none"> • Basic training to DS & below
Functional	Central Portals (e-office, NIC Portal, Grievance Portal, VIP Portal, Bhoomirashi Portal and any other relevant portal)	<ul style="list-style-type: none"> • Trainings on portals should be provided as part of induction/ refresher trainings to increase functional efficiency of the staff members.
	MS Office Skills (Word, PowerPoint, Excel)	<ul style="list-style-type: none"> • Trainings on MS office should be provided for better documentation, report writing, data management etc. • Advanced training to US and below. • Refresher/ induction training should be provided for all new joiners.
	Government documentation (noting, drafting, cabinet notes, parliamentary answers, reports, Memorandum of Understanding etc.), reporting for parliamentary procedures, questions, and RTI queries	<ul style="list-style-type: none"> • Trainings on Government documentation, protocols, processes, etc. should be provided to all staff members. • Trainings to be provided to all officers in positions and refresher/ induction trainings to be conducted for new joiners.
	Financial procedures/ GFR/ Bill clearances/ PFMS	<ul style="list-style-type: none"> • Basic knowledge of GFR/ Financial bills and operation of PFMS portal should be provided to all new joiners and other officers in position.
	GRM (Grievance Redressal Mechanism), CPGRAMs and INGRAMs Portals	<ul style="list-style-type: none"> • Trainings on portals should be provided as part of induction/ refresher trainings to increase functional efficiency of the staff members.
	Government procurement protocols, processes, and tools (RFP, Tender Evaluation, Tender Award, Government e Marketplace - GeM) etc.)	<ul style="list-style-type: none"> • Trainings on Government documentation, protocols, processes, understanding of tender, GeM portals etc. should be provided to all staff members. • Trainings to be provided to all officers in positions and refresher/ induction trainings to be conducted for new joiners.
Behavioural	Verbal communication; Liaisoning and Negotiation skills	<ul style="list-style-type: none"> • Communication trainings should be provided to all officer up to DS level.
	Multitasking and time management	<ul style="list-style-type: none"> • Trainings on multitasking and time management to be conducted for all officials to maintain healthy work life balance. • Advanced training for senior officers.
	Administrative and managerial skills	<ul style="list-style-type: none"> • Senior officials such as DS and above should be provided with advanced level trainings to upskill. • Induction / Refresher training to be provided for new joiners.
	Stakeholder and people management	<ul style="list-style-type: none"> • Trainings to handle and negotiate with stakeholders both internal and external shall be provided to the staffs for ease knowledge transfer through means of communication.
	Gender sensitization and anti-sexual harassment	<ul style="list-style-type: none"> • Such interpersonal trainings should be conducted at regular intervals and these trainings should be mandatory for all designations.
	Organizational skills (such as planning, delegation, knowledge of key responsibility areas, goal setting, team building etc.)	<ul style="list-style-type: none"> • Regular upskilling required to enhance organizational skills for all employees (particularly senior officers) to delegate matters effectively.
	Health and well-being, and stress management	<ul style="list-style-type: none"> • Trainings on balancing health to be provided to officers of all level.
	Adaptation to new skills and methodologies	<ul style="list-style-type: none"> • Regular upskilling is essential to pace up with the existing technological advancements and hence trainings should be provided to all officials to increase adaptability to new

		technologies and their operating procedures.
--	--	--

c) Establishment-IIB (E-IIB) Section

Figure 25: Organogram - EIIIB Division

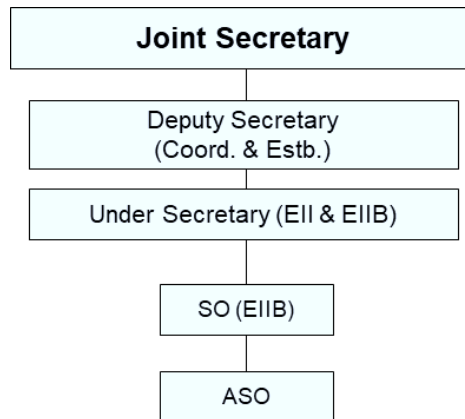

Key focus areas

- Appointment of Chairman and matters in NHAI,
- framing and amendment of Rules and Regulations for appointment of Chairman, Members,
- Routine administration of NHAI

Role of Establishment-IIB (E-IIB) Section

- Matters relating to appointment of Chairman and Members of the National Highways Authority of India (NHAI).
- Constitution of Search cum Selection Committee for appointment selection of CGM in consultation with DoPT in NHAI.
- Matters relating to extension of tenure of deputation of Chief General Managers (CGM). General Manager, DGMs and Managers in the National Highways Authority of India beyond their normal tenure.
- Framing/ Amendments of Recruitment rules for the General Central Service Group "B" and "C" posts.
- Other miscellaneous matters including permission for Air travel by other than Air India.
- All personnel matters including review of service cases under FR 56(j) ft Rule 48 of CCS (Pension) Rules of Subordinate technical cadres viz. Assistant Engineer (Civil), Technical Officers, Senior Technical Assistants, Technical Assistants.
- All Training Programmes involving participation of the officers and staff of this Ministry including its regional offices, autonomous bodies/societies/associate offices under the administrative purview of the Section. Formulation of Annual Training plan, calling for applications, consultations with technical wings, processing of cases for nominations taking into account career profile and other administrative aspects.

Roles and functions of various officer levels:

Designation	Role and functions
Joint Secretary	<ul style="list-style-type: none"> ○ Manages matters related to the appointment of Chairman and Members of the National Highways Authority of India (NHAI), ensuring adherence to established procedures and guidelines ○ Constitutes Search cum Selection Committees for the appointment and selection of Chief General Managers (CGM) in consultation with the Department of Personnel and Training (DoPT) for NHAI. ○ Oversees matters concerning the extension of tenure of deputation for Chief General Managers (CGM), General Managers, DGMs, and Managers in NHAI beyond their normal

Designation	Role and functions
	tenure.
Deputy Secretary (DS)	<ul style="list-style-type: none"> ○ Handles the framing and amendments of Recruitment Rules for General Central Service Group "B" and "C" posts within the Ministry. ○ Manages miscellaneous matters, including permissions for air travel by means other than Air India, ensuring compliance with relevant regulations. ○ Reviews service cases under FR 56(j) and Rule 48 of CCS (Pension) Rules for subordinate technical cadres such as Assistant Engineers (Civil), Technical Officers, Senior Technical Assistants, and Technical Assistants.
Under Secretary (US)	<ul style="list-style-type: none"> ○ Processes requests and grants permissions for air travel by means other than Air India, ensuring that travel is in line with applicable regulations. ○ Handles all personnel matters related to the review of service cases for subordinate technical cadres, taking into account FR 56(j) and Rule 48 of CCS (Pension) Rules.
Section Officer (SO)/ Assistant Section Officer (ASO)	<ul style="list-style-type: none"> ○ Coordinates with NHAJ for matters related to appointments, deputation extensions, and constitution of Search cum Selection Committees. ○ Implements and updates Recruitment Rules for Group "B" and "C" posts, ensuring that they align with the evolving needs of the Ministry. ○ Coordinates the logistics and administrative aspects of training programs, including consultation with technical wings and processing nominations based on career profiles and other relevant factors.

Based on the roles and functions, the domain competencies identified across various officer levels are:

Domain Competencies	JS	DS	US	SO/ ASO
Rules for appointment of chairman				
Awareness of Recruitment rules				
Knowledge of FR 56 (i) and Rule 48 of CCS Pension Rules				
Awareness of handling administrative matters of NHAJ				
Awareness of DoPT guidelines for officer trainings				

Level of intervention as per competency need assessed

High	Moderate	Low
------	----------	-----

The behavioural and functional competencies mapped for the section are the follows:

Type	Competencies	JS	DS	US	SO/ ASO
Functional	Central Portals (e-office, NIC Portal, Grievance Portal, VIP Portal, Bhoomirashi Portal and any other				

Type	Competencies	JS	DS	US	SO/ ASO
	relevant portal)				
	MS Office (Word, PowerPoint, Excel)				
	Government documentation (noting, drafting, cabinet notes, parliamentary answers, reports, Memorandum of Understanding etc.), reporting for parliamentary procedures, questions, and RTI queries				
	Financial procedures/ GFR/ Bill clearances/ PFMS				
	GRM (Grievance Redressal Mechanism), CPGRAMs and INGRAMs Portals				
	Government procurement protocols, processes, and tools (RFP, Tender Evaluation, Tender Award, Government e Marketplace - GeM) etc.)				
Behavioural	Verbal communication; Liaisoning and Negotiation skills				
	Multitasking and time management				
	Administrative and managerial skills				
	Stakeholder and people management				
	Gender sensitization and anti-sexual harassment				
	Organizational skills (such as planning, delegation, knowledge of key responsibility areas, goal setting, team building etc.)				
	Health and well-being, and stress management				
	Adaptation to new skills and methodologies				

Level of intervention as per competency need assessed

High	Moderate	Low
------	----------	-----

Training Need Assessment:

Type	Competency	Training Need Assessment
Domain	Rules for appointment of chairman	<ul style="list-style-type: none"> Induction material to all staff
	Awareness of Recruitment rules	<ul style="list-style-type: none"> Induction material to all staff
	Knowledge of FR 56 (i) and Rule 48 of CCS Pension Rules	<ul style="list-style-type: none"> Induction material to all staff
	Awareness of handling administrative matters of NHAI	<ul style="list-style-type: none"> Basic training to Officers (DS & below)
	Awareness of DoPT guidelines for officer trainings	<ul style="list-style-type: none"> Induction material to all staff
Functional	Central Portals (e-office, NIC Portal, Grievance Portal, VIP Portal, Bhoomirashi Portal and any other relevant portal)	<ul style="list-style-type: none"> Trainings on portals should be provided as part of induction/ refresher trainings to increase functional efficiency of the staff members.
	MS Office Skills (Word, PowerPoint, Excel)	<ul style="list-style-type: none"> Trainings on MS office should be provided for better documentation, report writing, data management etc.

		<ul style="list-style-type: none"> Advanced training to US and below. Refresher/ induction training should be provided for all new joiners.
	Government documentation (noting, drafting, cabinet notes, parliamentary answers, reports, Memorandum of Understanding etc.), reporting for parliamentary procedures, questions, and RTI queries	<ul style="list-style-type: none"> Trainings on Government documentation, protocols, processes, etc. should be provided to all staff members. Trainings to be provided to all officers in positions and refresher/ induction trainings to be conducted for new joiners.
	Financial procedures/ GFR/ Bill clearances/ PFMS	<ul style="list-style-type: none"> Basic knowledge of GFR/ Financial bills and operation of PFMS portal should be provided to all new joiners and other officers in position.
	GRM (Grievance Redressal Mechanism), CPGRAMs and INGRAMs Portals	<ul style="list-style-type: none"> Trainings on portals should be provided as part of induction/ refresher trainings to increase functional efficiency of the staff members.
	Government procurement protocols, processes, and tools (RFP, Tender Evaluation, Tender Award, Government e Marketplace - GeM) etc.)	<ul style="list-style-type: none"> Trainings on Government documentation, protocols, processes, understanding of tender, GeM portals etc. should be provided to all staff members. Trainings to be provided to all officers in positions and refresher/ induction trainings to be conducted for new joiners.
Behavioural	Verbal communication; Liaisoning and Negotiation skills	<ul style="list-style-type: none"> Communication trainings should be provided to all officer up to DS level.
	Multitasking and time management	<ul style="list-style-type: none"> Trainings on multitasking and time management to be conducted for all officials to maintain healthy work life balance. Advanced training for senior officers.
	Administrative and managerial skills	<ul style="list-style-type: none"> Senior officials such as DS and above should be provided with advanced level trainings to upskill. Induction / Refresher training to be provided for new joiners.
	Stakeholder and people management	<ul style="list-style-type: none"> Trainings to handle and negotiate with stakeholders both internal and external shall be provided to the staffs for ease knowledge transfer through means of communication.
	Gender sensitization and anti-sexual harassment	<ul style="list-style-type: none"> Such interpersonal trainings should be conducted at regular intervals and these trainings should be mandatory for all designations.
	Organizational skills (such as planning, delegation, knowledge of key responsibility areas, goal setting, team building etc.)	<ul style="list-style-type: none"> Regular upskilling required to enhance organizational skills for all employees (particularly senior officers) to delegate matters effectively.
	Health and well-being, and stress management	<ul style="list-style-type: none"> Trainings on balancing health to be provided to officers of all level.
	Adaptation to new skills and methodologies	<ul style="list-style-type: none"> Regular upskilling is essential to pace up with the existing technological advancements and hence trainings should be provided to all officials to increase adaptability to new technologies and their operating procedures.

d) General Section

Figure 26: Organogram - General Section

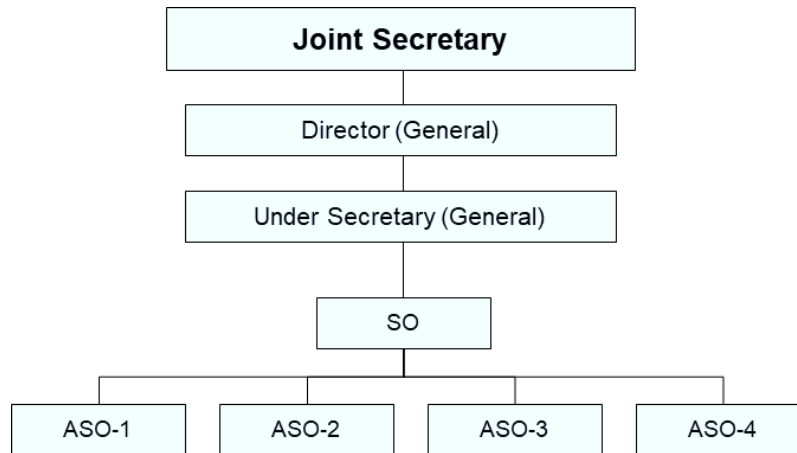

Key focus areas

- Procurement
- Distribution
- Maintenance
- Supervision

Role of General Section

- Tasks associated with paying bills for services such as hospitality, publications, telephones, telephone directories, intercom maintenance, etc.
- Newspaper invoices, photo I.D. cards, CGHS cards, No-Demand Certificates, temporary passes, etc.
- Creation of the Ministry's Establishment Budget, including Regional Offices.
- GPF withdrawals and advances. Additional advancements include those in house construction, bicycles, motor vehicles, festivals, etc.
- Tasks involving the leasing of office space for Regional Offices and the purchase or repair of vehicles for Regional Offices. The purchase and maintenance of all office equipment, including furniture,
- The planning of various welfare activities, such as farewell celebrations for retired Ministry officers and employees, the provision of first aid kits and medications etc.
- Establishment of the Departmental Canteen of the Ministry's Management Committee, which will oversee the Departmental Canteen's operation

Roles and functions of various officer levels:

Designation	Role and functions
Joint Secretary	<ul style="list-style-type: none"> ○ Overall coordination of activities within the General Section, ensuring that tasks related to paying bills, budget creation, and welfare activities are carried out efficiently. ○ Formulating policies related to the administration and functioning of the General Section, ensuring adherence to government regulations and guidelines. ○ Supervising the work of Deputy Secretary, Under Secretary, and Section Officer to ensure smooth functioning and timely completion of tasks.
Director	<ul style="list-style-type: none"> ○ Creation and management of the Ministry's Establishment Budget, including those for Regional Offices.

Designation	Role and functions
	<ul style="list-style-type: none"> Implementing policies related to the General Section's responsibilities, ensuring that bills are processed, and financial transactions are carried out in accordance with established procedures. Collaborating with Regional Offices for tasks such as leasing office space and procurement or repair of vehicles, ensuring that regional needs align with the overall objectives of the Ministry.
Under Secretary (US)	<ul style="list-style-type: none"> Managing financial transactions, such as GPF withdrawals and advances, and ensuring that all financial activities are conducted accurately and transparently. Maintaining proper documentation and records related to financial transactions, budget allocation, and other activities within the General Section. Collaborating with the Section Officer to streamline day-to-day operations and ensure that tasks are carried out efficiently.
Section Officer (SO)/ Assistant Section Officer (ASO)	<ul style="list-style-type: none"> Day-to-day operational aspects of the General Section, including tasks related to paying bills, newspaper invoices, and the purchase and maintenance of office equipment. Planning and coordinating various welfare activities, such as farewell celebrations and the provision of first aid kits, under the guidance of higher authorities. Establishment and management of the Departmental Canteen, ensuring its smooth operation.

Based on the roles and functions, the domain competencies identified across various officer levels are:

Domain Competencies	JS	Director	US	SO/ ASO
Awareness of CSMOP manual				
Awareness of matters related to maintenance, purchasing of office equipment of the Ministry				
Knowledge of GPF withdrawal and advances				
Knowledge of budget management				

Level of intervention as per competency need assessed

High	Moderate	Low
------	----------	-----

The behavioural and functional competencies mapped for the section are the follows:

Type	Competencies	JS	Director	US	SO/ ASO
Functional	Central Portals (e-office, NIC Portal, Grievance Portal, VIP Portal, Bhoomirashi Portal and any other relevant portal)				
	MS Office (Word, PowerPoint, Excel)				
	Government documentation (noting, drafting, cabinet notes, parliamentary answers, reports, Memorandum of Understanding etc.), reporting for parliamentary procedures, questions, and RTI queries				

Type	Competencies	JS	Director	US	SO/ ASO
	Financial procedures/ GFR/ Bill clearances/ PFMS				
	GRM (Grievance Redressal Mechanism), CPGRAMs and INGRAMs Portals				
	Government procurement protocols, processes, and tools (RFP, Tender Evaluation, Tender Award, Government e Marketplace - GeM) etc.)				
Behavioural	Verbal communication; Liaisoning and Negotiation skills				
	Multitasking and time management				
	Administrative and managerial skills				
	Stakeholder and people management				
	Gender sensitization and anti-sexual harassment				
	Organizational skills (such as planning, delegation, knowledge of key responsibility areas, goal setting, team building etc.)				
	Health and well-being, and stress management				
	Adaptation to new skills and methodologies				

Level of intervention as per competency need assessed

High	Moderate	Low
------	----------	-----

Training Need Assessment

Type	Competencies	Need Assessment
Domain	Awareness of CSMOP manual	<ul style="list-style-type: none"> • Induction material to all staff
	Awareness of matters related to maintenance, purchasing of office equipment of the Ministry	<ul style="list-style-type: none"> • Basic training to US and below
	Knowledge of GPF withdrawal and advances	<ul style="list-style-type: none"> • Basic training to DS and below
	Knowledge of budget management	<ul style="list-style-type: none"> • Basic training to all staff
Functional	Central Portals (e-office, NIC Portal, Grievance Portal, VIP Portal, Bhoomirashi Portal and any other relevant portal)	<ul style="list-style-type: none"> • Trainings on portals should be provided as part of induction/ refresher trainings to increase functional efficiency of the staff members.
	MS Office Skills (Word, PowerPoint, Excel)	<ul style="list-style-type: none"> • Intermediate trainings on MS office should be provided for better documentation, report writing, data management etc. • Advanced training to US and below.
	Government documentation (noting, drafting, cabinet notes, parliamentary answers, reports, Memorandum of Understanding etc.), reporting for parliamentary procedures, questions, and RTI queries	<ul style="list-style-type: none"> • Trainings on Government documentation, protocols, processes, etc. should be provided to all staff members. • Trainings to be provided to all officers in positions and refresher/ induction trainings to be conducted for new joiners.

Type	Competencies	Need Assessment
	Financial procedures/ GFR/ Bill clearances/ PFMS	<ul style="list-style-type: none"> Basic knowledge of GFR/ Financial bills and operation of PFMS portal should be provided to all new joiners and other officers in position.
	GRM (Grievance Redressal Mechanism), CPGRAMs and INGRAMs Portals	<ul style="list-style-type: none"> Trainings on portals should be provided as part of induction/ refresher trainings to increase functional efficiency of the staff members (DS and below).
	Government procurement protocols, processes, and tools (RFP, Tender Evaluation, Tender Award, Government e Marketplace - GeM) etc.)	<ul style="list-style-type: none"> Trainings to be provided to all officers in positions and refresher/ induction trainings to be conducted for existing staff/ new joiners.
	Judicial Pronouncement and Restrictions, Audit Paras and Court Cases	<ul style="list-style-type: none"> Mandatory trainings to handle matters related to court and other PMO related Q&A should be provided to all officers (DS & below)
Behavioural	Verbal communication; Liaisoning and Negotiation skills	<ul style="list-style-type: none"> Communication trainings should be provided to all officer up to DS level.
	Multitasking and time management	<ul style="list-style-type: none"> Trainings on multitasking and time management to be conducted for all officials to maintain healthy work life balance. Advanced training for senior officers (JS & DS)
	Administrative and managerial skills	<ul style="list-style-type: none"> Intermediate training to Officers US and below Induction / Refresher training to be provided for new joiners.
	Stakeholder and people management	<ul style="list-style-type: none"> Trainings to handle and negotiate with stakeholders both internal and external shall be provided to officers (DS & below).
	Gender sensitization and anti-sexual harassment	<ul style="list-style-type: none"> Interpersonal and gender sensitization trainings should be conducted at regular intervals and these trainings should be mandatory for all designations.
	Organizational skills (such as planning, delegation, knowledge of key responsibility areas, goal setting, team building etc.)	<ul style="list-style-type: none"> Requirement to enhance organizational skills for all employees (particularly senior officers) to delegate matters effectively.
	Health and well-being, and stress management	<ul style="list-style-type: none"> Importance of proper healthy wellbeing should be taught to individuals. Frequent trainings on balancing health for senior officers (JS & DS).
	Adaptation to new skills and methodologies	<ul style="list-style-type: none"> Regular upskilling is essential to pace up with the existing technological advancements and hence trainings should be provided to all officials to increase adaptability to new technologies and their operating procedures.

e) Coordination Section

Figure 27: Organogram - Coordination Section

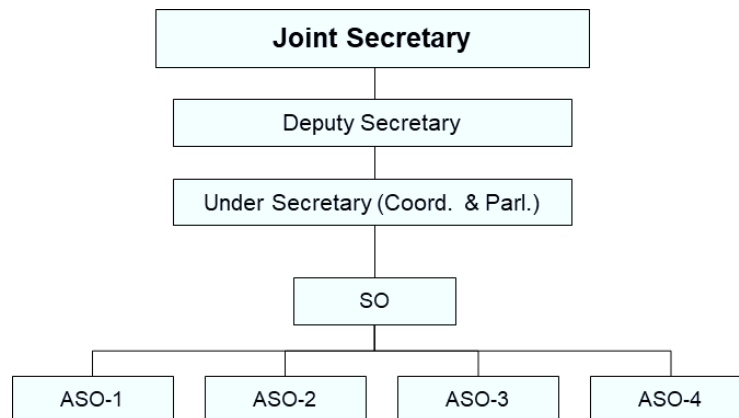

Key focus areas

- Annual Report and related publications
- Coordination between Wings/ Divisions/Sections
- MP/VIP references

Role of Coordination Section

- Reference from President Secretariat/Vice-President Secretariat/Prime Minister's Office/Other Central Government Ministries/Departments.
- Matters pertaining to Cabinet Meetings, Cabinet Committee Meetings and Secretary's meeting.
- Monthly D.O. letter from Secretary to Cabinet Secretary regarding important developments in respect of Ministry of Road Transport and Highways.
- Monthly Summary of important developments in respect of Ministry of Road Transport & Highways.
- Annual Report of the Ministry of Road Transport and Highways.
- All Parliament Questions/Assurances received from other Ministries/Department where coordination of work is involved.
- Seminars in India (except those allotted to and dealt with by Admn. Wing, RT Wing & P&M Zone).
- Monitoring of disposal of References from PMO/Cabinet Secretariat etc. and preparation and submission of fortnight/weekly, (as prescribed from time to time) return in respect of these references to Secretary (RT&H).
- Monthly return to Cabinet Secretary regarding status of vacancies and proposals in the PSUs/Banks/Autonomous Bodies/DPC Selections, etc.
- Draft Cabinet Notes from other Ministries/Departments where coordination between different Wings of the Ministry of Road Transport and Highways is involved.
- Compilation of list of officers of the Ministry and forwarding the lists to Ministry of Defence and distribution of Invitation Cards for National Ceremonies like Independence Day/Republic Day, etc.
- Coordination of collection of material for (a) President's Address to both the Houses of Parliament (b) Finance Minister's Speech.
- Coordination of work (With different Wings) with reference to implementation of decisions of the Cabinet, Cabinet Committee (except ACC which is allotted to Admn, Wing)
- Monitoring of status of disposal of MP/VIP references

Roles and functions of various officer levels:

Designation	Role and functions
JS	<ul style="list-style-type: none"> In charge of the Coordination Section is responsible for overall coordination of activities related to external references from President Secretariat, PMO, and other Central Government Ministries/Departments. Handles matters pertaining to Cabinet Meetings, Cabinet Committee Meetings, and Secretary's meetings, ensuring that relevant information is communicated to the concerned authorities. Coordinates with different wings of the Ministry to ensure the smooth implementation of decisions taken in Cabinet meetings and Cabinet Committee meetings.
DS	<ul style="list-style-type: none"> Communication and reporting of important developments within the Ministry, including the preparation of monthly D.O. letters from the Secretary to the Cabinet Secretary. Manage all Parliament Questions/Assurances received from other Ministries/Departments where coordination of work is involved, ensuring timely and accurate responses. Handle draft Cabinet Notes from other Ministries/Departments where coordination between different wings of the Ministry is required.
US	<ul style="list-style-type: none"> Monitors the disposal of references from President Secretariat, PMO, and other Central Government Ministries/Departments. Submits monthly returns to the Cabinet Secretary regarding the status of vacancies and proposals in the PSUs/Banks/Autonomous Bodies/DPC Selections. Monitors the status of disposal of MP/VIP references and ensures timely responses.
SO/ ASO	<ul style="list-style-type: none"> Compiles material for important speeches, such as the President's Address to both Houses of Parliament and the Finance Minister's Speech, in coordination with different wings of the Ministry. Manages the compilation of lists of officers for distribution to the Ministry of Defence and the distribution of Invitation Cards for National Ceremonies like Independence Day/Republic Day. Coordinates seminars in India, ensuring seamless execution.

Based on the roles and functions, the domain competencies identified across various officer levels are:

Domain Competencies	JS	DS	US	SO/ ASO
Awareness of annual report publication				
Knowledge of VIP, MP references and related matters				
Coordination and collection of materials within the section for Minister's speech				
Handling matters pertaining to Cabinet Meetings, Cabinet Committee Meetings and Secretary's meeting.				
Coordination of work (With different Wings) with reference to implementation of decisions of the Cabinet				

Level of intervention as per competency need assessed

High	Moderate	Low
------	----------	-----

The behavioural and functional competencies mapped for the section are the follows:

Type	Competencies	JS	DS	US	SO/ ASO

Type	Competencies	JS	DS	US	SO/ ASO
Functional	Central Portals (e-office, NIC Portal, Grievance Portal, VIP Portal, Bhoomirashi Portal and any other relevant portal)				
	MS Office (Word, PowerPoint, Excel)				
	Government documentation (noting, drafting, cabinet notes, parliamentary answers, reports, Memorandum of Understanding etc.), reporting for parliamentary procedures, questions, and RTI queries				
	Financial procedures/ GFR/ Bill clearances/ PFMS				
	GRM (Grievance Redressal Mechanism), CPGRAMs and INGRAMs Portals				
	Government procurement protocols, processes, and tools (RFP, Tender Evaluation, Tender Award, Government e Marketplace - GeM) etc.)				
Behavioural	Verbal communication; Liaisoning and Negotiation skills				
	Multitasking and time management				
	Administrative and managerial skills				
	Stakeholder and people management				
	Gender sensitization and anti-sexual harassment				
	Organizational skills (such as planning, delegation, knowledge of key responsibility areas, goal setting, team building etc.)				
	Health and well-being, and stress management				
	Adaptation to new skills and methodologies				

Level of intervention as per competency need assessed

High	Moderate	Low
------	----------	-----

Training Need Assessment:

Type	Competency	Training Need Assessment
Domain	Awareness of annual report publication	<ul style="list-style-type: none"> Induction material to all staff
	Knowledge of VIP, MP references and related matters	<ul style="list-style-type: none"> Basic training to DS US & below
	Coordination and collection of materials within the section for Minister's speech	<ul style="list-style-type: none"> Basic training to DS US & below
	Handling matters pertaining to Cabinet Meetings, Cabinet Committee Meetings and Secretary's meeting.	<ul style="list-style-type: none"> Training to All staff
	Coordination of work (With different Wings) with reference to implementation of decisions of the Cabinet	<ul style="list-style-type: none"> Basic training to DS US & below
Functional	Central Portals (e-office, NIC Portal, Grievance Portal, VIP Portal, Bhoomirashi Portal and any other relevant portal)	<ul style="list-style-type: none"> Trainings on portals should be provided as part of induction/ refresher trainings to increase functional efficiency of the staff

		members.
	MS Office Skills (Word, PowerPoint, Excel)	<ul style="list-style-type: none"> • Trainings on MS office should be provided for better documentation, report writing, data management etc. • Advanced training to US and below. • Refresher/ induction training should be provided for all new joiners.
	Government documentation (noting, drafting, cabinet notes, parliamentary answers, reports, Memorandum of Understanding etc.), reporting for parliamentary procedures, questions, and RTI queries	<ul style="list-style-type: none"> • Trainings on Government documentation, protocols, processes, etc. should be provided to all staff members. • Trainings to be provided to all officers in positions and refresher/ induction trainings to be conducted for new joiners.
	Financial procedures/ GFR/ Bill clearances/ PFMS	<ul style="list-style-type: none"> • Basic knowledge of GFR/ Financial bills and operation of PFMS portal should be provided to all new joiners and other officers in position.
	GRM (Grievance Redressal Mechanism), CPGRAMs and INGRAMs Portals	<ul style="list-style-type: none"> • Trainings on portals should be provided as part of induction/ refresher trainings to increase functional efficiency of the staff members.
	Government procurement protocols, processes, and tools (RFP, Tender Evaluation, Tender Award, Government e Marketplace - GeM) etc.)	<ul style="list-style-type: none"> • Trainings on Government documentation, protocols, processes, understanding of tender, GeM portals etc. should be provided to all staff members. • Trainings to be provided to all officers in positions and refresher/ induction trainings to be conducted for new joiners.
Behavioural	Verbal communication; Liaisoning and Negotiation skills	<ul style="list-style-type: none"> • Communication trainings should be provided to all officer up to DS level.
	Multitasking and time management	<ul style="list-style-type: none"> • Trainings on multitasking and time management to be conducted for all officials to maintain healthy work life balance. • Advanced training for senior officers.
	Administrative and managerial skills	<ul style="list-style-type: none"> • Senior officials such as DS and above should be provided with advanced level trainings to upskill. • Induction / Refresher training to be provided for new joiners.
	Stakeholder and people management	<ul style="list-style-type: none"> • Trainings to handle and negotiate with stakeholders both internal and external shall be provided to the staffs for ease knowledge transfer through means of communication.
	Gender sensitization and anti-sexual harassment	<ul style="list-style-type: none"> • Such interpersonal trainings should be conducted at regular intervals and these trainings should be mandatory for all designations.
	Organizational skills (such as planning, delegation, knowledge of key responsibility areas, goal setting, team building etc.)	<ul style="list-style-type: none"> • Regular upskilling required to enhance organizational skills for all employees (particularly senior officers) to delegate matters effectively.
	Health and well-being, and stress management	<ul style="list-style-type: none"> • Trainings on balancing health to be provided to officers of all level.
	Adaptation to new skills and methodologies	<ul style="list-style-type: none"> • Regular upskilling is essential to pace up with the existing technological advancements and hence trainings should be provided to all officials to increase adaptability to new technologies and their operating procedures.

f) Parliament Section

The section is headed by the Joint Secretary. It manages the tasks of supervising and monitoring the parliamentary related matters to all wings and divisions and other sections in the Ministry. Ranging from the Q&A parliamentary sessions, to write notice, and preparing letters etc. The Section has other subordinate staff as well to conduct other administrative tasks.

Figure 28: Parliament Section

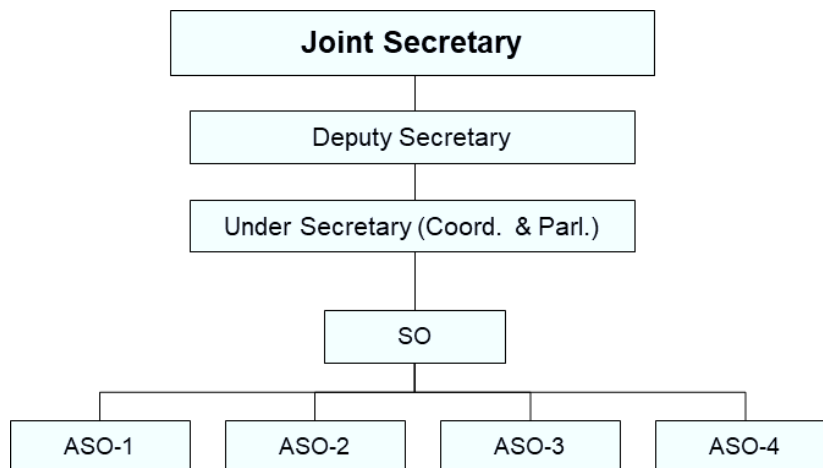

Key focus areas

- Parliamentary Assurances
- Starred and Unstarred Questions
- Coordination with various Wings/ Divisions/ Sections

Role of Parliament Section

- Parliamentary work pertaining to receipt and distribution of notices of the Parliament Questions, list of Starred/ Unstarred /Short Notice Questions etc. Preparation of sets of answers to Parliament Questions and delivering them to Lok Sabha and Rajya Sabha Sectt., Press Information Bureau etc.
- Parliamentary Assurances, Matters raised under the rule 377 of Lok Sabha, Special mentions in Rajya Sabha – compilation and updating there of To convene meetings of the Consultative Committee attached to this Ministry and coordination of the work connected therewith.
- To keep a track of legislative Proposals (Bills), their compilation pertaining to this Ministry.
- Work relating to various types of statements made in the Parliament pertaining to this Ministry.
- Coordination and follow up for the work (such as forwarding ATRs (including Hindi version) prepared by the concerned Wings to respective Secretariats of the Lok Sabha/Rajya Sabha, processing the names of officers to attend various Committee meetings of LS/Rs, monitor the submission of folders for meetings etc. relating to the Parliamentary Committees, such as committee on subordinate Legislation, Committee on papers laid, Committee on Govt. Assurances, Deptt. Related standing Committee, Committee on Estimates etc.
- To deals with references received from Lok Sabha and Rajya Sabha Sectt. Ministry of Parliamentary Affairs on Parliamentary matters.
- To arrange meetings for briefing the Minister (RT&H), Ministers of State(RT&H) for replying to Parliament questions, Calling Attention Motions, Half-an-Hour Discussions, consideration and padding of Legislative Business.
- Forwarding of answers to the Starred/Unstarred Parliament Questions to Lok/Rajya Sabha through e-mail.

Roles and functions of various officer levels:

Designation	Role and functions
Joint Secretary	<p>Overall in-charge of administration of the section and the following on key tasks on a regular basis.</p> <ul style="list-style-type: none"> Oversee the overall functioning of the Parliament Section and ensure smooth coordination of parliamentary activities. Supervise the preparation and compilation of answers to Parliament Questions, ensuring accuracy and adherence to guidelines. Coordinate with the Consultative Committee attached to the Ministry, convening meetings and facilitating discussions. Monitor legislative proposals (Bills) related to the Ministry and provide timely updates to the higher authorities. Handle references received from Lok Sabha and Rajya Sabha Secretariats and Ministry of Parliamentary Affairs, addressing parliamentary matters effectively.
Deputy Secretary (DS)	<ul style="list-style-type: none"> Assist in the preparation of sets of answers to Parliament Questions and their timely delivery to the Lok Sabha and Rajya Sabha Secretariats. Compile and update information on matters raised under Rule 377 of Lok Sabha and Special mentions in Rajya Sabha. Coordinate the submission of folders and relevant documents for various Committee meetings, such as the Committee on subordinate Legislation, Committee on papers laid, etc. Manage the processing of officers' names to attend Committee meetings and ensure compliance with procedural requirements. Assist in arranging meetings for briefing the Minister and Ministers of State on parliamentary matters.
Under Secretary (US)	<ul style="list-style-type: none"> Handle the day-to-day coordination and follow-up for parliamentary work, including forwarding Action Taken Reports (ATRs) to the Lok Sabha and Rajya Sabha Secretariats. Process the names of officers attending various Committee meetings and monitor the submission of required documents. Assist in the compilation and updating of parliamentary assurances and statements made in the Parliament related to the Ministry. Coordinate with the Press Information Bureau for the dissemination of information related to parliamentary activities. Manage the forwarding of answers to Starred/Unstarred Parliament Questions through electronic means.
Section Officer (SO)/ Assistant Section Officer (ASO)	<ul style="list-style-type: none"> Handle routine administrative tasks related to the Parliament Section. Assist in the organization of meetings, including those of the Consultative Committee, and ensure logistical arrangements. Maintain records and documentation related to legislative proposals and parliamentary activities. Support the preparation and delivery of various types of statements made in the Parliament. Provide administrative support for arranging meetings and briefings for the Minister and Ministers of State on parliamentary proceedings.

Based on the roles and functions, the domain competencies identified across various officer levels are:

Domain Competencies	JS	DS	US	SO	ASO
Parliamentary procedures/ CCEA / Cabinet matters to address the Q&A					

Domain Competencies	JS	DS	US	SO	ASO
Parliamentary bills, laws, and acts					
Compilation and updating of Parliamentary Assurances					
Issues Raised Under Rule 377 of the Lok Sabha, and Special Mentions in the Rajya Sabha					
Managing meetings of the Consultative Committee linked to the Ministry					
Sectoral Group of Secretaries (SGoS)					

Level of intervention as per competency need assessed

High	Moderate	Low
------	----------	-----

The behavioural and functional competencies mapped for the section are the follows:

Type	Competencies	JS	DS	US	SO	ASO
Functional	Central Portals (e-office, NIC Portal, Grievance Portal, VIP Portal, Bhoomirashi Portal and any other relevant portal)					
	MS Office Skills (Word, PowerPoint, Excel)					
	Government documentation (noting, drafting, cabinet notes, parliamentary answers, reports, Memorandum of Understanding etc.), reporting for parliamentary procedures, questions, and RTI queries					
	Financial procedures/ GFR/ Bill clearances/ PFMS					
	GRM (Grievance Redressal Mechanism), CPGRAMs and INGRAMs Portals					
	Government procurement protocols, processes, and tools (RFP, Tender Evaluation, Tender Award, Government e Marketplace – GeM) etc.)					
	Judicial Pronouncement and Restrictions, Audit Paras and Court Cases					
Behavioural	Verbal communication; Liaisoning and Negotiation skills					
	Multitasking and time management					
	Administrative and managerial skills					
	Stakeholder and people management					
	Gender sensitization and anti-sexual harassment					
	Organizational skills (such as planning, delegation, knowledge of key responsibility areas, goal setting, team building etc.)					
	Health and well-being, and stress management					

Type	Competencies	JS	DS	US	SO	ASO
	Adaptation to new skills and methodologies					

Level of intervention as per competency need assessed

High

Moderate

Low

Training Need Assessment

Type	Competencies	Need Assessment
Domain	Parliamentary procedures/ CCEA / Cabinet matters to address the Q&A	<ul style="list-style-type: none"> • Induction training to be provided to all new joiners • Intermediate level training for US and below
	Parliamentary bills, laws, and acts	<ul style="list-style-type: none"> • Induction training to be provided to all new joiners, along with refreshed training to all officers to keep them updated about latest legislations and rules • Intermediate level training for US and below
	Compilation and updating of Parliamentary Assurances	<ul style="list-style-type: none"> • Induction training to be provided to all new joiners • Intermediate level training for US and below
	Issues Raised Under Rule 377 of the Lok Sabha, and Special Mentions in the Rajya Sabha	<ul style="list-style-type: none"> • Intermediate level training for US and below
	Managing meetings of the Consultative Committee linked to the Ministry	<ul style="list-style-type: none"> • Induction training to be provided to all new joiners • Intermediate level training for US and below
	Sectoral Group of Secretaries (SGoS)	<ul style="list-style-type: none"> • Induction training to be provided to all new joiners • Intermediate level training for US and below
Functional	Central Portals (e-office, NIC Portal, Grievance Portal, VIP Portal, Bhoomirashi Portal and any other relevant portal)	<ul style="list-style-type: none"> • Trainings on portals should be provided as part of induction/ refresher trainings to increase functional efficiency of the staff members.
	MS Office Skills (Word, PowerPoint, Excel)	<ul style="list-style-type: none"> • Intermediate trainings on MS office should be provided for better documentation, report writing, data management etc. • Advanced training to US and below.
	Government documentation (noting, drafting, cabinet notes, parliamentary answers, reports, Memorandum of Understanding etc.), reporting for parliamentary procedures, questions, and RTI queries	<ul style="list-style-type: none"> • Trainings on Government documentation, protocols, processes, etc. should be provided to all staff members. • Trainings to be provided to all officers in positions and refresher/ induction trainings to be conducted for new joiners.
	Financial procedures/ GFR/ Bill clearances/ PFMS	<ul style="list-style-type: none"> • Basic knowledge of GFR/ Financial bills and operation of PFMS portal should be provided to all new joiners and other officers in position.
	GRM (Grievance Redressal Mechanism), CPGRAMs and INGRAMs Portals	<ul style="list-style-type: none"> • Trainings on portals should be provided as part of induction/ refresher trainings to increase functional efficiency of the staff members (DS and below).
	Government procurement protocols, processes, and tools (RFP, Tender Evaluation, Tender Award, Government e Marketplace - GeM) etc.)	<ul style="list-style-type: none"> • Trainings to be provided to all officers in positions and refresher/ induction trainings to be conducted for existing staff/ new joiners.

Type	Competencies	Need Assessment
	Judicial Pronouncement and Restrictions, Audit Paras and Court Cases	<ul style="list-style-type: none"> Mandatory trainings to handle matters related to court and other PMO related Q&A should be provided to all officers (DS & below)
Behavioural	Verbal communication; Liaisoning and Negotiation skills	<ul style="list-style-type: none"> Communication trainings should be provided to all officer up to DS level.
	Multitasking and time management	<ul style="list-style-type: none"> Trainings on multitasking and time management to be conducted for all officials to maintain healthy work life balance. Advanced training for senior officers (JS & DS)
	Administrative and managerial skills	<ul style="list-style-type: none"> Intermediate training to Officers US and below Induction / Refresher training to be provided for new joiners.
	Stakeholder and people management	<ul style="list-style-type: none"> Trainings to handle and negotiate with stakeholders both internal and external shall be provided to officers (DS & below).
	Gender sensitization and anti-sexual harassment	<ul style="list-style-type: none"> Interpersonal and gender sensitization trainings should be conducted at regular intervals and these trainings should be mandatory for all designations.
	Organizational skills (such as planning, delegation, knowledge of key responsibility areas, goal setting, team building etc.)	<ul style="list-style-type: none"> Requirement to enhance organizational skills for all employees (particularly senior officers) to delegate matters effectively.
	Health and well-being, and stress management	<ul style="list-style-type: none"> Importance of proper healthy wellbeing should be taught to individuals. Frequent trainings on balancing health for senior officers (JS & DS).
	Adaptation to new skills and methodologies	<ul style="list-style-type: none"> Regular upskilling is essential to pace up with the existing technological advancements and hence trainings should be provided to all officials to increase adaptability to new technologies and their operating procedures.

g) RTI Section

Figure 29: Organogram - RTI Section

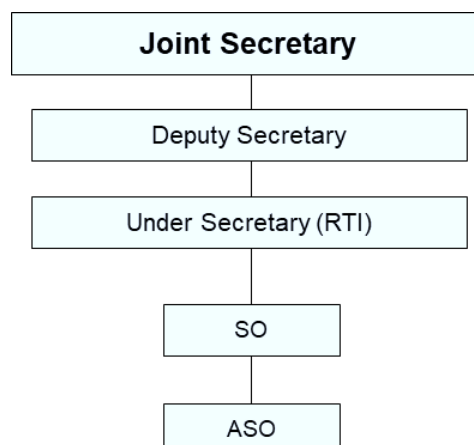

Key focus areas

- Implementation of Right to Information, 2005
- Processing of applications related to RTIs pertaining to MoRTH

Role of RTI Section

- Implementation of various provisions of the Right to Information Act, 2005 in the Ministry of Road Transport and Highways.
- Monitoring of updating of the information in website by NIC in consultation with the respective wing Heads.
- Monitoring of the dissemination of information about the Ministry under Section 4 (1) (b) of the RTI Act.
- Furnishing of quarterly information to the Central Information Commission for their Annual Report as per the provisions of RTI Act,2005.
- Setting up norms for the discharge of Ministry's functions as public authority.
- Implementation of rules, regulations, instructions framed/issued under the RTI Act by the DOP&T.
- Receiving of applications from the public, processing them for forwarding to the respective designated officers (de facto PIOs), ensuring of furnishing of reply to the public within the stipulated time period of 30 days and transfer of applications received under RTI Act to other concerned public authorities.
- Other miscellaneous works like, furnishing of information in respect of applications received under RTI Act to Minister and other higher officers, as and when asked, correspondence with and seeking clarifications from DOP&T on matters relating to the RTI Act.

Roles and functions of various officer levels:

Designation	Role and functions
JS	<ul style="list-style-type: none"> ○ Formulating policies related to the implementation of various provisions of the Right to Information (RTI) Act, 2005 within the Ministry. ○ Sets up norms for the discharge of the Ministry's functions as a public authority under the RTI Act, ensuring compliance with the legal framework. ○ Coordinates with different wings and designated officers to ensure effective implementation of RTI provisions and compliance with rules and regulations.
DS	<ul style="list-style-type: none"> ○ Monitors the updating of information on the Ministry's website by the NIC in consultation with the respective wing heads, ensuring that the information is accurate and up-to-date. ○ Oversees the dissemination of information about the Ministry under Section 4 (1) (b) of the RTI Act, making relevant information accessible to the public. ○ Furnishes quarterly information to the Central Information Commission for their Annual Report, as per the provisions of the RTI Act, 2005.
US	<ul style="list-style-type: none"> ○ Implement rules, regulations, and instructions framed/issued under the RTI Act by the Department of Personnel and Training (DOP&T). ○ Receive applications from the public, processes them for forwarding to the respective designated officers (de facto PIOs), and ensures that replies are furnished within the stipulated time period ○ Manage the transfer of applications received under the RTI Act to other concerned public authorities when necessary.
SO/ ASO	<ul style="list-style-type: none"> ○ Handle miscellaneous works related to the RTI Section, including furnishing information in response to applications received under the RTI Act to the Minister and other higher officers as required. ○ Engages in correspondence with and seeks clarifications from the DOP&T on matters relating to the RTI Act, ensuring that the Ministry's practices align with regulatory requirements.

Based on the roles and functions, the domain competencies identified across various officer levels are:

Domain Competencies	JS	DS	US	SO/ ASO

Domain Competencies	JS	DS	US	SO/ ASO
Awareness of CSMOP manual				
Awareness of RTI Act, 2005				
Furnishing of quarterly information to the Central Information Commission				

Level of intervention as per competency need assessed

High	Moderate	Low
------	----------	-----

The behavioural and functional competencies mapped for the section are the follows:

Type	Competencies	JS	DS	US	SO/ ASO
Functional	Central Portals (e-office, NIC Portal, Grievance Portal, VIP Portal, Bhoomirashi Portal and any other relevant portal)				
	MS Office (Word, PowerPoint, Excel)				
	Government documentation (noting, drafting, cabinet notes, parliamentary answers, reports, Memorandum of Understanding etc.), reporting for parliamentary procedures, questions, and RTI queries				
	Financial procedures/ GFR/ Bill clearances/ PFMS				
	GRM (Grievance Redressal Mechanism), CPGRAMs and INGRAMs Portals				
	Government procurement protocols, processes, and tools (RFP, Tender Evaluation, Tender Award, Government e Marketplace - GeM) etc.)				
Behavioural	Verbal communication; Liaisoning and Negotiation skills				
	Multitasking and time management				
	Administrative and managerial skills				
	Stakeholder and people management				
	Gender sensitization and anti-sexual harassment				
	Organizational skills (such as planning, delegation, knowledge of key responsibility areas, goal setting, team building etc.)				
	Health and well-being, and stress management				
	Adaptation to new skills and methodologies				

Level of intervention as per competency need assessed

High	Moderate	Low
------	----------	-----

Training Need Assessment:

Type	Competency	Training Need Assessment
Domain	Awareness of CSMOP manual	<ul style="list-style-type: none"> Induction material to be provided to all staff
	Awareness of RTI Act, 2005	<ul style="list-style-type: none"> Induction material to be provided to all staff
	Furnishing of quarterly information to the Central Information Commission	<ul style="list-style-type: none"> Regular workshops to US and below
Functional	Central Portals (e-office, NIC Portal, Grievance Portal, VIP Portal, Bhoomirashi Portal and any other relevant portal)	<ul style="list-style-type: none"> Trainings on portals should be provided as part of induction/ refresher trainings to increase functional efficiency of the staff members.
	MS Office Skills (Word, PowerPoint, Excel)	<ul style="list-style-type: none"> Trainings on MS office should be provided for better documentation, report writing, data management etc. Advanced training to US and below. Refresher/ induction training should be provided for all new joiners.
	Government documentation (noting, drafting, cabinet notes, parliamentary answers, reports, Memorandum of Understanding etc.), reporting for parliamentary procedures, questions, and RTI queries	<ul style="list-style-type: none"> Trainings on Government documentation, protocols, processes, etc. should be provided to all staff members. Trainings to be provided to all officers in positions and refresher/ induction trainings to be conducted for new joiners.
	Financial procedures/ GFR/ Bill clearances/ PFMS	<ul style="list-style-type: none"> Basic knowledge of GFR/ Financial bills and operation of PFMS portal should be provided to all new joiners and other officers in position.
	GRM (Grievance Redressal Mechanism), CPGRAMs and INGRAMs Portals	<ul style="list-style-type: none"> Trainings on portals should be provided as part of induction/ refresher trainings to increase functional efficiency of the staff members.
	Government procurement protocols, processes, and tools (RFP, Tender Evaluation, Tender Award, Government e Marketplace - GeM) etc.)	<ul style="list-style-type: none"> Trainings on Government documentation, protocols, processes, understanding of tender, GeM portals etc. should be provided to all staff members. Trainings to be provided to all officers in positions and refresher/ induction trainings to be conducted for new joiners.
Behavioural	Verbal communication; Liaisoning and Negotiation skills	<ul style="list-style-type: none"> Communication trainings should be provided to all officer up to DS level.
	Multitasking and time management	<ul style="list-style-type: none"> Trainings on multitasking and time management to be conducted for all officials to maintain healthy work life balance. Advanced training for senior officers.
	Administrative and managerial skills	<ul style="list-style-type: none"> Senior officials such as DS and above should be provided with advanced level trainings to upskill. Induction / Refresher training to be provided for new joiners.
	Stakeholder and people management	<ul style="list-style-type: none"> Trainings to handle and negotiate with stakeholders both internal and external shall be provided to the staffs for ease knowledge transfer through means of communication.
	Gender sensitization and anti-sexual harassment	<ul style="list-style-type: none"> Such interpersonal trainings should be conducted at regular intervals and these trainings should be mandatory for all designations.
	Organizational skills (such as planning, delegation, knowledge of key responsibility areas, goal setting, team building etc.)	<ul style="list-style-type: none"> Regular upskilling required to enhance organizational skills for all employees (particularly senior officers) to delegate matters effectively,
	Health and well-being, and stress management	<ul style="list-style-type: none"> Trainings on balancing health to be provided to officers of all level.

	Adaptation to new skills and methodologies	<ul style="list-style-type: none"> Regular upskilling is essential to pace up with the existing technological advancements and hence trainings should be provided to all officials to increase adaptability to new technologies and their operating procedures.
--	--	--

h) CR Section

Figure 30: Organogram - CR Section

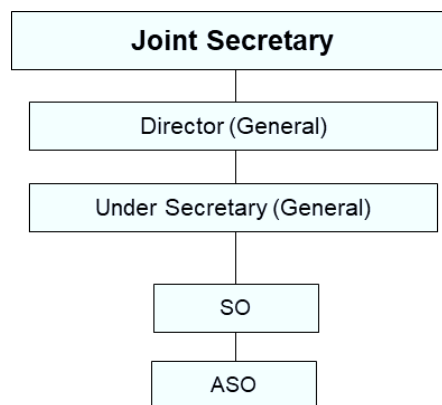

Key focus areas

- Grievance redressal
- Citizens Charter

Role of CR Section

- Dealing all the grievances forwarded by Department of Administrative reforms and Public Grievance/DPG/President Sectt. and other local grievances.
- Speedy movement of receipt and dispatch of various categories like Court Cases, Parliamentary references, VIP references, Most Immediate/Urgent Dak.
- Preparation and amendment of Citizens charter of the Ministry.

Roles and functions of various officer levels:

Designation	Role and functions
JS	<ul style="list-style-type: none"> Overseeing the handling of grievances forwarded by the Department of Administrative Reforms and Public Grievance (DARPG), DoPT, President's Secretariat, and other local grievances. Participates in the preparation and amendment of the Citizens Charter of the Ministry, defining the standards of service delivery and commitments to the public
DS	<ul style="list-style-type: none"> Processes and manages the handling of grievances received by the CR Section, coordinating with relevant departments and officers for timely resolution. Ensures the speedy movement of various categories of documents, including court cases, parliamentary references, VIP references, and most immediate/urgent mail Works on the implementation of the Citizens Charter, making necessary amendments as required to enhance the quality of services provided by the Ministry..
US	<ul style="list-style-type: none"> Deals with local grievances and coordinates with concerned authorities to address them promptly. Manages the receipt and dispatch of various categories of documents, ensuring efficiency and timely responses. Monitors the implementation of the Citizens Charter, gathering feedback, and suggesting

Designation	Role and functions
	improvements as necessary.
SO/ ASO	<ul style="list-style-type: none"> ○ Handles the day-to-day processing and resolution of grievances, including coordination with different sections and officers involved in addressing specific grievances. ○ Manages the receipt and dispatch of documents in the CR Section, ensuring that documents are routed to the appropriate departments for necessary action

Based on the roles and functions, the domain competencies identified across various officer levels are:

Domain Competencies	JS	DS	US	SO/ ASO
Awareness of CSMOP manual				
Awareness of handling grievances				
Awareness of managing citizen charter				
Handling approvals and sanctions of postal expenditure				
Managing receipts for various dispatch categories such as court cases etc.				

Level of intervention as per competency need assessed

High	Moderate	Low
------	----------	-----

The behavioural and functional competencies mapped for the section are the follows:

Type	Competencies	JS	DS	US	SO/ ASO
Functional	Central Portals (e-office, NIC Portal, Grievance Portal, VIP Portal, Bhoomirashi Portal and any other relevant portal)				
	MS Office (Word, PowerPoint, Excel)				
	Government documentation (noting, drafting, cabinet notes, parliamentary answers, reports, Memorandum of Understanding etc.), reporting for parliamentary procedures, questions, and RTI queries				
	Financial procedures/ GFR/ Bill clearances/ PFMS				
	GRM (Grievance Redressal Mechanism), CPGRAMs and INGRAMs Portals				
	Government procurement protocols, processes, and tools (RFP, Tender Evaluation, Tender Award, Government e Marketplace - GeM) etc.)				
Behavi	Verbal communication; Liaisoning and Negotiation skills				
	Multitasking and time management				

Type	Competencies	JS	DS	US	SO/ ASO
	Administrative and managerial skills	High	High	Low	High
	Stakeholder and people management	Low	High	High	High
	Gender sensitization and anti-sexual harassment	High	High	High	Low
	Organizational skills (such as planning, delegation, knowledge of key responsibility areas, goal setting, team building etc.)	Low	Low	High	High
	Health and well-being, and stress management	High	High	Low	Low
	Adaptation to new skills and methodologies	High	High	High	High

Level of intervention as per competency need assessed

High	Moderate	Low
------	----------	-----

Training Need Assessment:

Type	Competency	Training Need Assessment
Domain	Awareness of CSMOP manual	<ul style="list-style-type: none"> Induction material to be provided to all staff
	Awareness of handling grievances	<ul style="list-style-type: none"> Induction material to be provided to all staff
	Awareness of managing citizen charter	<ul style="list-style-type: none"> Induction material to be provided to all staff
	Handling approvals and sanctions of postal expenditure	<ul style="list-style-type: none"> Induction material to be provided to all staff
	Managing receipts for various dispatch categories such as court cases etc.	<ul style="list-style-type: none"> Basic training to be provided to officers (up to DS level)
Functional	Central Portals (e-office, NIC Portal, Grievance Portal, VIP Portal, Bhoomirashi Portal and any other relevant portal)	<ul style="list-style-type: none"> Trainings on portals should be provided as part of induction/ refresher trainings to increase functional efficiency of the staff members.
	MS Office Skills (Word, PowerPoint, Excel)	<ul style="list-style-type: none"> Trainings on MS office should be provided for better documentation, report writing, data management etc. Advanced training to US and below. Refresher/ induction training should be provided for all new joiners.
	Government documentation (noting, drafting, cabinet notes, parliamentary answers, reports, Memorandum of Understanding etc.), reporting for parliamentary procedures, questions, and RTI queries	<ul style="list-style-type: none"> Trainings on Government documentation, protocols, processes, etc. should be provided to all staff members. Trainings to be provided to all officers in positions and refresher/ induction trainings to be conducted for new joiners.
	Financial procedures/ GFR/ Bill clearances/ PFMS	<ul style="list-style-type: none"> Basic knowledge of GFR/ Financial bills and operation of PFMS portal should be provided to all new joiners and other officers in position.
	GRM (Grievance Redressal Mechanism), CPGRAMs and INGRAMs Portals	<ul style="list-style-type: none"> Trainings on portals should be provided as part of induction/ refresher trainings to increase functional efficiency of the staff members.
	Government procurement protocols, processes, and tools (RFP, Tender Evaluation, Tender Award, Government e Marketplace - GeM) etc.)	<ul style="list-style-type: none"> Trainings on Government documentation, protocols, processes, understanding of tender, GeM portals etc. should be provided to all staff members. Trainings to be provided to all officers in positions and refresher/ induction trainings to be conducted for new joiners.

Behavioural	Verbal communication; Liaisoning and Negotiation skills	<ul style="list-style-type: none"> Communication trainings should be provided to all officer up to DS level.
	Multitasking and time management	<ul style="list-style-type: none"> Trainings on multitasking and time management to be conducted for all officials to maintain healthy work life balance. Advanced training for senior officers.
	Administrative and managerial skills	<ul style="list-style-type: none"> Senior officials such as DS and above should be provided with advanced level trainings to upskill. Induction / Refresher training to be provided for new joiners.
	Stakeholder and people management	<ul style="list-style-type: none"> Trainings to handle and negotiate with stakeholders both internal and external shall be provided to the staffs for ease knowledge transfer through means of communication.
	Gender sensitization and anti-sexual harassment	<ul style="list-style-type: none"> Such interpersonal trainings should be conducted at regular intervals and these trainings should be mandatory for all designations.
	Organizational skills (such as planning, delegation, knowledge of key responsibility areas, goal setting, team building etc.)	<ul style="list-style-type: none"> Regular upskilling required to enhance organizational skills for all employees (particularly senior officers) to delegate matters effectively.
	Health and well-being, and stress management	<ul style="list-style-type: none"> Trainings on balancing health to be provided to officers of all level.
	Adaptation to new skills and methodologies	<ul style="list-style-type: none"> Regular upskilling is essential to pace up with the existing technological advancements and hence trainings should be provided to all officials to increase adaptability to new technologies and their operating procedures.

i) O&M Section

Figure 31: Organogram - O&M Section

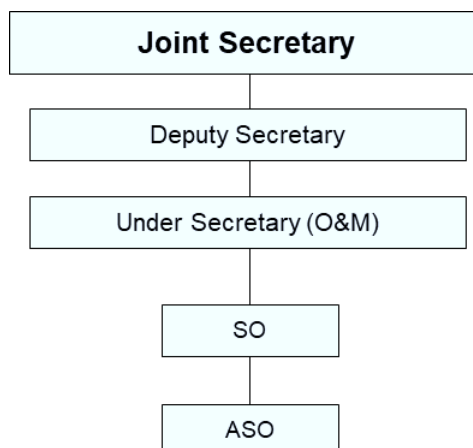

Role of OM Section

- All O&M matters which includes following:
 - O&M inspection of Sections/Desks in the Ministry.
 - Matters relating to Central Secretariat manual of office procedure.
 - Measures for toning up of effective and responsive administration in the Ministry and its lower formations.
 - Collection/Compilation of instructions relating to list of such subjects being dealt with in various sections of the Ministry.
 - Review and updation of instructions relating to level of final disposal of business allocated to the Ministry with reference to transaction of Business rules.
 - Compiling of status report on Review of Act, rules etc. in respect of the Ministry

- Record Management under the Public Records Act 1993 and the Public Records Rules, 1997 framed by the National Archives of India.
- Liaison with the DAR&PG and the National Archives of India on O&M matters.

Roles and functions of various officer levels:

Designation	Role and functions
JS	<ul style="list-style-type: none"> Conducting O&M inspections of Sections/Desks within the Ministry to assess and improve operational efficiency. Overseeing the implementation of measures outlined in the Central Secretariat Manual of Office Procedure for streamlined operations. Developing measures to enhance effective and responsive administration within the Ministry and its lower formations
DS	<ul style="list-style-type: none"> Reviewing and updating instructions related to the level of final disposal of business allocated to the Ministry in accordance with Transaction of Business Rules. Compiling status reports on the review of Acts, rules, and other relevant regulations concerning the Ministry.
US	<ul style="list-style-type: none"> Managing record-keeping processes under the Public Records Act 1993 and the Public Records Rules 1997, as framed by the National Archives of India. Maintaining liaison with the Department of Administrative Reforms and Public Grievances (DAR&PG) and the National Archives of India on O&M matters.
SO/ ASO	<ul style="list-style-type: none"> Ensuring the implementation of O&M measures and policies within the assigned sections of the Ministry. Compiling data and information relevant to O&M functions, supporting decision-making processes. Coordinating with other sections and departments for the effective execution of O&M initiatives within the Ministry.

Based on the roles and functions, the domain competencies identified across various officer levels are:

Domain Competencies	JS	DS	US	SO/ ASO
Awareness of CSMOP manual				
Knowledge of inspection of sections/ wings				
Awareness of Record Management under the Public Records Act 1993				
Knowledge of Public Records Rules, 1997				
Preparation of compiled report on review of Acts/Rules				

Level of intervention as per competency need assessed

High	Moderate	Low
------	----------	-----

The behavioural and functional competencies mapped for the section are the follows:

Type	Competencies	JS	DS	US	SO/ ASO
Functional	Central Portals (e-office, NIC Portal, Grievance Portal, VIP Portal, Bhoomirashi Portal and any other				

Type	Competencies	JS	DS	US	SO/ ASO
	relevant portal)				
	MS Office (Word, PowerPoint, Excel)				
	Government documentation (noting, drafting, cabinet notes, parliamentary answers, reports, Memorandum of Understanding etc.), reporting for parliamentary procedures, questions, and RTI queries				
	Financial procedures/ GFR/ Bill clearances/ PFMS				
	GRM (Grievance Redressal Mechanism), CPGRAMs and INGRAMs Portals				
	Government procurement protocols, processes, and tools (RFP, Tender Evaluation, Tender Award, Government e Marketplace - GeM) etc.)				
Behavioural	Verbal communication; Liaisoning and Negotiation skills				
	Multitasking and time management				
	Administrative and managerial skills				
	Stakeholder and people management				
	Gender sensitization and anti-sexual harassment				
	Organizational skills (such as planning, delegation, knowledge of key responsibility areas, goal setting, team building etc.)				
	Health and well-being, and stress management				
	Adaptation to new skills and methodologies				

Level of intervention as per competency need assessed

High

Moderate

Low

Training Need Assessment:

Type	Competency	Training Need Assessment
Domain	Awareness of CSMOP manual	<ul style="list-style-type: none"> Induction material to be provided to all staff
	Knowledge of inspection of sections/ wings	<ul style="list-style-type: none"> Induction material to be provided to all staff
	Awareness of Record Management under the Public Records Act 1993	<ul style="list-style-type: none"> Induction material to be provided to all staff
	Knowledge of Public Records Rules, 1997	<ul style="list-style-type: none"> Induction material to be provided to all staff
	Preparation of compiled report on review of Acts/Rules	<ul style="list-style-type: none"> Basic training to be provided to officers (up to DS level)
Functional	Central Portals (e-office, NIC Portal, Grievance Portal, VIP Portal, Bhoomirashi Portal and any other relevant portal)	<ul style="list-style-type: none"> Trainings on portals should be provided as part of induction/ refresher trainings to increase functional efficiency of the staff members.
	MS Office Skills (Word, PowerPoint, Excel)	<ul style="list-style-type: none"> Trainings on MS office should be provided for better documentation, report writing, data management etc.

		<ul style="list-style-type: none"> Advanced training to US and below. Refresher/ induction training should be provided for all new joiners.
	Government documentation (noting, drafting, cabinet notes, parliamentary answers, reports, Memorandum of Understanding etc.), reporting for parliamentary procedures, questions, and RTI queries	<ul style="list-style-type: none"> Trainings on Government documentation, protocols, processes, etc. should be provided to all staff members. Trainings to be provided to all officers in positions and refresher/ induction trainings to be conducted for new joiners.
	Financial procedures/ GFR/ Bill clearances/ PFMS	<ul style="list-style-type: none"> Basic knowledge of GFR/ Financial bills and operation of PFMS portal should be provided to all new joiners and other officers in position.
	GRM (Grievance Redressal Mechanism), CPGRAMs and INGRAMs Portals	<ul style="list-style-type: none"> Trainings on portals should be provided as part of induction/ refresher trainings to increase functional efficiency of the staff members.
	Government procurement protocols, processes, and tools (RFP, Tender Evaluation, Tender Award, Government e Marketplace - GeM) etc.)	<ul style="list-style-type: none"> Trainings on Government documentation, protocols, processes, understanding of tender, GeM portals etc. should be provided to all staff members. Trainings to be provided to all officers in positions and refresher/ induction trainings to be conducted for new joiners.
Behavioural	Verbal communication; Liaisoning and Negotiation skills	<ul style="list-style-type: none"> Communication trainings should be provided to all officer up to DS level.
	Multitasking and time management	<ul style="list-style-type: none"> Trainings on multitasking and time management to be conducted for all officials to maintain healthy work life balance. Advanced training for senior officers.
	Administrative and managerial skills	<ul style="list-style-type: none"> Senior officials such as DS and above should be provided with advanced level trainings to upskill. Induction / Refresher training to be provided for new joiners.
	Stakeholder and people management	<ul style="list-style-type: none"> Trainings to handle and negotiate with stakeholders both internal and external shall be provided to the staffs for ease knowledge transfer through means of communication.
	Gender sensitization and anti-sexual harassment	<ul style="list-style-type: none"> Such interpersonal trainings should be conducted at regular intervals and these trainings should be mandatory for all designations.
	Organizational skills (such as planning, delegation, knowledge of key responsibility areas, goal setting, team building etc.)	<ul style="list-style-type: none"> Regular upskilling required to enhance organizational skills for all employees (particularly senior officers) to delegate matters effectively.
	Health and well-being, and stress management	<ul style="list-style-type: none"> Trainings on balancing health to be provided to officers of all level.
	Adaptation to new skills and methodologies	<ul style="list-style-type: none"> Regular upskilling is essential to pace up with the existing technological advancements and hence trainings should be provided to all officials to increase adaptability to new technologies and their operating procedures.

j) Cash Section

Figure 32: Organogram - Cash Section

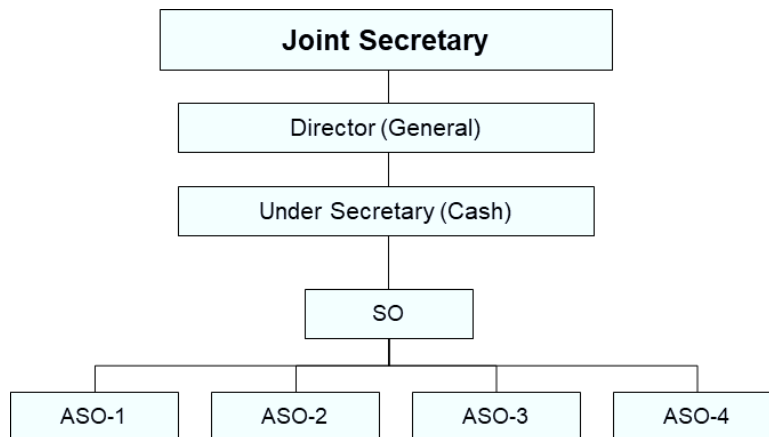

Key focus areas

- Maintaining accounts and cash

Role of Cash Section

- Depositing of fees received from the applicants with cash section and maintaining of its accounts.
- Monitoring of the disposal of the applications/requests from public by issuing reminders to the designated officers de facto PIOs).
- Publishing of names, designation, postal addresses and contact details of Central Public Information Officers and Public Information Officers, Appellate Authorities of the Ministry and other information such as notices regarding fees to be paid in respect of applications received from the citizens for information.
- Furnishing of quarterly information to the Central Information Commission for their Annual Report as per the provisions of RTI Act,2005.

Roles and functions of various officer levels:

Designation	Role and functions
JS	<ul style="list-style-type: none"> ○ Providing strategic oversight and direction for financial operations within the Cash Department. ○ Formulating policies and guidelines related to the deposition of fees, account maintenance, and financial processes. ○ Ensuring compliance with financial regulations, conducting audits, and implementing measures to improve financial efficiency. ○ Coordinating with other departments and stakeholders to facilitate smooth financial transactions and operations.
Director	<ul style="list-style-type: none"> ○ Overseeing the deposition of fees received from applicants, maintaining accurate accounts, and ensuring financial transparency. ○ Monitoring the disposal of applications/requests from the public and issuing reminders to designated officers (de facto PIOs) for timely resolution. ○ Preparing and submitting regular reports on financial transactions, fee collection, and application disposal to higher authorities.
US	<ul style="list-style-type: none"> ○ Publishing names, designations, postal addresses, and contact details of Central Public Information Officers (CPIOs), Public Information Officers (PIOs), Appellate Authorities, and other relevant information. ○ Issuing notices regarding fees for applications received from citizens for information, ensuring transparency in the fee payment process. ○ Furnishing quarterly information to the Central Information Commission for their Annual Report in accordance with the provisions of the RTI Act, 2005.

Designation	Role and functions
SO/ ASO	<ul style="list-style-type: none"> ○ Handling the day-to-day processing of financial transactions, including the deposition of fees and maintenance of accounts. ○ Maintaining accurate records of financial transactions, fee collections, and application disposals. ○ Tracking and recording the status of applications, ensuring timely follow-up and resolution. ○ Coordinating with other sections and departments for the seamless execution of financial and administrative functions within the Cash Department.

Based on the roles and functions, the domain competencies identified across various officer levels are:

Domain Competencies	JS	Director	US	SO/ ASO
Financial management				
Accounting skills				
Data analytics				
Knowledge on RTI Act				

Level of intervention as per competency need assessed

High	Moderate	Low
------	----------	-----

The behavioural and functional competencies mapped for the section are the follows:

Type	Competencies	JS	Director	US	SO/ ASO
Functional	Central Portals (e-office, NIC Portal, Grievance Portal, VIP Portal, Bhoomirashi Portal and any other relevant portal)				
	MS Office (Word, PowerPoint, Excel)				
	Government documentation (noting, drafting, cabinet notes, parliamentary answers, reports, Memorandum of Understanding etc.), reporting for parliamentary procedures, questions, and RTI queries				
	Financial procedures/ GFR/ Bill clearances/ PFMS				
	GRM (Grievance Redressal Mechanism), CPGRAMs and INGRAMs Portals				
	Project Management, controlling and reporting including various project management tools and techniques.				
	Government procurement protocols, processes, and tools (RFP, Tender Evaluation, Tender Award, Government e Marketplace - GeM) etc.)				
Behavi	Verbal communication; Liaisoning and Negotiation skills				
	Multitasking and time management				

Type	Competencies	JS	Director	US	SO/ ASO
	Administrative and managerial skills				
	Stakeholder and people management				
	Gender sensitization and anti-sexual harassment				
	Organizational skills (such as planning, delegation, knowledge of key responsibility areas, goal setting, team building etc.)				
	Health and well-being, and stress management				
	Adaptation to new skills and methodologies				

Level of intervention as per competency need assessed

High	Moderate	Low
------	----------	-----

Training Need Assessment:

Type	Competency	Training Need Assessment
Domain	Financial management	<ul style="list-style-type: none"> Induction/ refresher training to US & below
	Accounting skills	<ul style="list-style-type: none"> Induction/ refresher training to US & below
	Data analytics	<ul style="list-style-type: none"> Advanced training to US & below
	Knowledge on RTI Act	<ul style="list-style-type: none"> Induction material to be provided to all staff
Functional	Central Portals (e-office, NIC Portal, Grievance Portal, VIP Portal, Bhoomirashi Portal and any other relevant portal)	<ul style="list-style-type: none"> Trainings on portals should be provided as part of induction/ refresher trainings to increase functional efficiency of the staff members.
	MS Office Skills (Word, PowerPoint, Excel)	<ul style="list-style-type: none"> Trainings on MS office should be provided for better documentation, report writing, data management etc. Advanced training to US and below. Refresher/ induction training should be provided for all new joiners.
	Government documentation (noting, drafting, cabinet notes, parliamentary answers, reports, Memorandum of Understanding etc.), reporting for parliamentary procedures, questions, and RTI queries	<ul style="list-style-type: none"> Trainings on Government documentation, protocols, processes, etc. should be provided to all staff members. Trainings to be provided to all officers in positions and refresher/ induction trainings to be conducted for new joiners.
	Financial procedures/ GFR/ Bill clearances/ PFMS	<ul style="list-style-type: none"> Basic knowledge of GFR/ Financial bills and operation of PFMS portal should be provided to all new joiners and other officers in position.
	GRM (Grievance Redressal Mechanism), CPGRAMs and INGRAMs Portals	<ul style="list-style-type: none"> Trainings on portals should be provided as part of induction/ refresher trainings to increase functional efficiency of the staff members.
	Government procurement protocols, processes, and tools (RFP, Tender Evaluation, Tender Award, Government e Marketplace - GeM) etc.)	<ul style="list-style-type: none"> Trainings on Government documentation, protocols, processes, understanding of tender, GeM portals etc. should be provided to all staff members. Trainings to be provided to all officers in positions and refresher/ induction trainings to be conducted for new joiners.
Verbal communication; Liaisoning and Negotiation skills	<ul style="list-style-type: none"> Effective communication plays a crucial role in handling day 	

		<p>to day ministerial activities in both written and verbal form. It encourages effective dialogue. Negotiation, understanding on perspectives, building relationships and smooth transfer of knowledge.</p> <ul style="list-style-type: none"> Hence, communication trainings should be provided to all officer up to Director level.
	Multitasking and time management	<ul style="list-style-type: none"> Trainings on multitasking and time management to be conducted for all officials to maintain healthy work life balance. Advanced training for senior officers.
	Administrative and managerial skills	<ul style="list-style-type: none"> To run an efficient team, training should be provided for enhancing the managerial skills of the section staff. It will increase the sense of decision making, communication, strategic planning etc. Senior officials such as Director and above should be provided with advanced level trainings to upskill. Induction / Refresher training to be provided for new joiners.
	Stakeholder and people management	<ul style="list-style-type: none"> Trainings to handle and negotiate with stakeholders both internal and external shall be provided to the staffs for ease knowledge transfer through means of communication.
	Gender sensitization and anti-sexual harassment	<ul style="list-style-type: none"> To promote inclusivity, enhance organizational culture, prevent harassment at workplace, regular trainings should be provided on sensitive topics such as sexual harassment. Such interpersonal trainings should be conducted at regular intervals and these trainings should be mandatory for all designations.
	Organizational skills (such as planning, delegation, knowledge of key responsibility areas, goal setting, team building etc.)	<ul style="list-style-type: none"> Regular upskilling required to enhance organizational skills for all employees (particularly senior officers) to delegate matters effectively,
	Health and well-being, and stress management	<ul style="list-style-type: none"> Trainings on balancing health to be provided to officers of all level.
	Adaptation to new skills and methodologies	<ul style="list-style-type: none"> Regular upskilling is essential to pace up with the existing technological advancements and hence trainings should be provided to all officials to increase adaptability to new technologies and their operating procedures.

k) Hindi Section

Figure 33: Organogram - Hindi Section

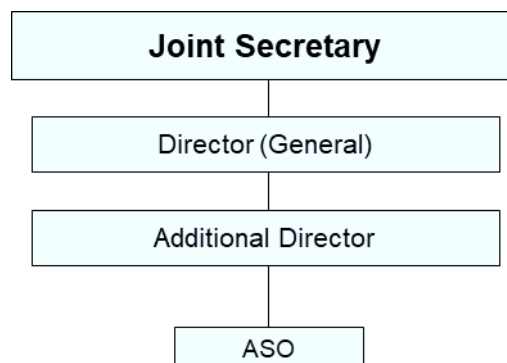

Key focus areas

- Translation of documents to Hindi
- Compliance with Official Languages Act

Role of Hindi Section

- Translation from English to Hindi and vice versa of all documents required to be sent to Parliament, viz. Parliament Questions and replies, Assurances Notifications, Resolutions etc. as also of all letters, Cabinet Notes, Action Taken Note on CAG's Paras, Minutes of the meetings of Consultative Committee and other Parliamentary Committees, Trade Agreements, Memorandum of Understanding (MOU) with different countries, performance Budget Annual Report Brief of the Audited Accounts and Annual Reports of the lower formations of the Ministry Estimates Committee, Public Accounts Committee, Departmental Magazine and various other documents received from time to time from various Sections of the Ministry.
- To take steps to ensure compliance of Official Languages Act, Rues, Annual Programme issued by the Department of official language etc. in the Ministry.
- To coordinate between Central Hindi Training Institutes, Department of official language and Establishment Sections of the Ministry for training in Hindi language/Hindi Stenography/Hindi Typing of the officers/staff of the Ministry. The trainees, in turn are nominated and relieved by the concerned Establishment Section of the Ministry.

Roles and functions of various officer levels:

Designation	Role and functions
JS	<ul style="list-style-type: none"> ○ Overall monitoring of the functioning of section ○ Coordinate with stakeholder departments for translation requirements
Director	<ul style="list-style-type: none"> ○ Support JS in managing the section works including coordination with stakeholder departments ○ Review (Proof read) translated document on case to case basis ○ Ensure overall quality of outputs of translated documents
Additional Director	<ul style="list-style-type: none"> ○ Proof read the outputs produced by ASO ○ Support Director in ensuring quality outputs
ASO	<ul style="list-style-type: none"> ○ Translation of documents to Hindi Language

Based on the roles and functions, the domain competencies identified across various officer levels are:

Domain Competencies	JS	Director	AD	ASO
Document Translation				
Language proficiency				
Understanding of technical and legal terminologies				
Proof reading				
Quality assurance				

Level of intervention as per competency need assessed

High	Moderate	Low
------	----------	-----

The behavioural and functional competencies mapped for the section are the follows:

Type	Competencies	JS	Director	AD	ASO
Functional	Central Portals (e-office, NIC Portal, Grievance Portal, VIP Portal, Bhoomirashi Portal and any other relevant portal)				
	MS Office (Word, PowerPoint, Excel)				
	Government documentation (noting, drafting, cabinet notes, parliamentary answers, reports, Memorandum of Understanding etc.), reporting for parliamentary procedures, questions, and RTI queries				
	GRM (Grievance Redressal Mechanism), CPGRAMs and INGRAMs Portals				
	Government procurement protocols, processes, and tools (RFP, Tender Evaluation, Tender Award, Government e Marketplace - GeM) etc.)				
Behavioural	Verbal communication; Liaisoning and Negotiation skills				
	Multitasking and time management				
	Administrative and managerial skills				
	Stakeholder and people management				
	Gender sensitization and anti-sexual harassment				
	Organizational skills (such as planning, delegation, knowledge of key responsibility areas, goal setting, team building etc.)				
	Health and well-being, and stress management				
	Adaptation to new skills and methodologies				

Level of intervention as per competency need assessed

High	Moderate	Low
------	----------	-----

Training Need Assessment:

Type	Competency	Training Need Assessment
Domain	Document Translation	<ul style="list-style-type: none"> Refresher training for AD and below
	Language proficiency	<ul style="list-style-type: none"> Refresher training for AD and below
	Understanding of technical and legal terminologies	<ul style="list-style-type: none"> Refresher training for AD and below
	Proof reading	<ul style="list-style-type: none"> Refresher training for AD and below
	Quality assurance	<ul style="list-style-type: none"> Advanced training for Director and below
Functional	Central Portals (e-office, NIC Portal, Grievance Portal, VIP Portal, Bhoomirashi Portal and any other relevant portal)	<ul style="list-style-type: none"> Trainings on portals should be provided as part of induction/ refresher trainings to increase functional efficiency of the staff members.
	MS Office Skills (Word, PowerPoint, Excel)	<ul style="list-style-type: none"> Trainings on MS office should be provided for better documentation, report writing, data management etc. Advanced training to US and below. Refresher/ induction training should be provided for all new

		joiners.
	Government documentation (noting, drafting, cabinet notes, parliamentary answers, reports, Memorandum of Understanding etc.), reporting for parliamentary procedures, questions, and RTI queries	<ul style="list-style-type: none"> • Trainings on Government documentation, protocols, processes, etc. should be provided to all staff members. • Trainings to be provided to all officers in positions and refresher/ induction trainings to be conducted for new joiners.
	GRM (Grievance Redressal Mechanism), CPGRAMs and INGRAMs Portals	<ul style="list-style-type: none"> • Trainings on portals should be provided as part of induction/ refresher trainings to increase functional efficiency of the staff members.
	Government procurement protocols, processes, and tools (RFP, Tender Evaluation, Tender Award, Government e Marketplace - GeM) etc.)	<ul style="list-style-type: none"> • Trainings on Government documentation, protocols, processes, understanding of tender, GeM portals etc. should be provided to all staff members. • Trainings to be provided to all officers in positions and refresher/ induction trainings to be conducted for new joiners.
Behavioural	Verbal communication; Liaisoning and Negotiation skills	<ul style="list-style-type: none"> • Effective communication plays a crucial role in handling day to day ministerial activities in both written and verbal form. It encourages effective dialogue. Negotiation, understanding on perspectives, building relationships and smooth transfer of knowledge. • Hence, communication trainings should be provided to all officer up to Director level.
	Multitasking and time management	<ul style="list-style-type: none"> • Trainings on multitasking and time management to be conducted for all officials to maintain healthy work life balance. • Advanced training for senior officers.
	Administrative and managerial skills	<ul style="list-style-type: none"> • To run an efficient team, training should be provided for enhancing the managerial skills of the section staff. It will increase the sense of decision making, communication, strategic planning etc. • Senior officials such as Director and above should be provided with advanced level trainings to upskill.
	Stakeholder and people management	<ul style="list-style-type: none"> • Trainings to handle and negotiate with stakeholders both internal and external shall be provided to the staffs for ease knowledge transfer through means of communication.
	Gender sensitization and anti-sexual harassment	<ul style="list-style-type: none"> • Such interpersonal trainings should be conducted at regular intervals and these trainings should be mandatory for all designations.
	Organizational skills (such as planning, delegation, knowledge of key responsibility areas, goal setting, team building etc.)	<ul style="list-style-type: none"> • Regular upskilling required to enhance organizational skills for all employees (particularly senior officers) to delegate matters effectively,
	Health and well-being, and stress management	<ul style="list-style-type: none"> • Trainings on balancing health to be provided to officers of all level.
	Adaptation to new skills and methodologies	<ul style="list-style-type: none"> • Regular upskilling is essential to pace up with the existing technological advancements and hence trainings should be provided to all officials to increase adaptability to new technologies and their operating procedures.

l) Vigilance Section

Figure 34: Organogram - Vigilance Section

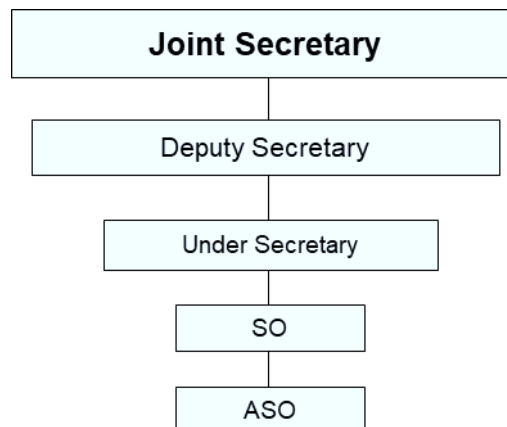

Key focus areas

- Receipt and processing of complaints of vigilance
- Implementation of Anti-corruption measures

Role of Vigilance

- Receipt and security of all complaints of vigilance nature addressed to the Department for disposal/ necessary action.
- Processing of reports received from CBI.
- Consultation with Central Vigilance Commission in vigilance cases involving Gazetted Officers.
- Departmental Proceedings in vigilance cases of officers/members of staff of the Ministry.
- Processing of the cases of appeal, representations and petitions filed in the Court wherever the penalty had been imposed by the Government after consultation with the Central Vigilance Commission.
- Action plan of the DOP&T on Anti-Corruption measures and implementation there of Processing of various periodical returns prescribed by DOP&T, CVC, PMO, Ministry of External Affairs & CBI.
- Vigilance Clearance in respect of officers and staff of the Ministry of Road Transport & Highways.
- Safe Custody of passports of officers of the Ministry.

Roles and functions of various officer levels:

Designation	Role and functions
JS	<ul style="list-style-type: none"> ○ Provide strategic oversight and direction for vigilance related activities ○ Formulating guidelines related to vigilance procedures and anti-corruption measures ○ Coordinate with government agencies including CVC, CBI etc for vigilance related matters ○ Conduct regular review and evaluation of vigilance work and framework
DS	<ul style="list-style-type: none"> ○ Oversee the receipt, security and handling of all complaints ○ Managing the processing of reports received from CVC/ CBI ○ Directing and overseeing departmental proceedings in vigilance cases involving officers and staff
US	<ul style="list-style-type: none"> ○ Facilitating consultation with CVC ○ Handling the processing of various periodical returns prescribed by DoPT, CVC etc. ○ Managing vigilance clearance proceedings for officers and staff
SO/ ASO	<ul style="list-style-type: none"> ○ Ensuring proper documentation and safe custody of passports of officers ○ Providing administrative support in processing of vigilance clearances ○ Maintaining records related to vigilance complaints and other relevant documents

Based on the roles and functions, the domain competencies identified across various officer levels are:

Domain Competencies	JS	DS	US	SO/ ASO
Case investigation skills				
Legal understanding and knowledge of relevant Acts and rules				
Documentation and record keeping				
Risk Management				

Level of intervention as per competency need assessed

High	Moderate	Low
------	----------	-----

The behavioural and functional competencies mapped for the section are the follows:

Type	Competencies	JS	DS	US	SO/ ASO
Functional	Central Portals (e-office, NIC Portal, Grievance Portal, VIP Portal, Bhoomirashi Portal and any other relevant portal)				
	MS Office (Word, PowerPoint, Excel)				
	Government documentation (noting, drafting, cabinet notes, parliamentary answers, reports, Memorandum of Understanding etc.), reporting for parliamentary procedures, questions, and RTI queries				
	Financial procedures/ GFR/ Bill clearances/ PFMS				
	GRM (Grievance Redressal Mechanism), CPGRAMs and INGRAMs Portals				
	Government procurement protocols, processes, and tools (RFP, Tender Evaluation, Tender Award, Government e Marketplace - GeM) etc.)				
Behavioural	Verbal communication; Liaisoning and Negotiation skills				
	Multitasking and time management				
	Administrative and managerial skills				
	Stakeholder and people management				
	Gender sensitization and anti-sexual harassment				
	Organizational skills (such as planning, delegation, knowledge of key responsibility areas, goal setting, team building etc.)				
	Health and well-being, and stress management				
	Adaptation to new skills and methodologies				

Level of intervention as per competency need assessed

High

Moderate

Low

Training Need Assessment:

Type	Competency	Training Need Assessment
Domain	Case investigation skills	<ul style="list-style-type: none"> Advanced training of Senior Officers
	Legal understanding and knowledge of relevant Acts and rules	<ul style="list-style-type: none"> Induction material to all staff
	Documentation and record keeping	<ul style="list-style-type: none"> Basic training to US and below
	Risk Management	<ul style="list-style-type: none"> Basic training to US and below
Functional	Central Portals (e-office, NIC Portal, Grievance Portal, VIP Portal, Bhoomirashi Portal and any other relevant portal)	<ul style="list-style-type: none"> Trainings on portals should be provided as part of induction/ refresher trainings to increase functional efficiency of the staff members.
	MS Office Skills (Word, PowerPoint, Excel)	<ul style="list-style-type: none"> Trainings on MS office should be provided for better documentation, report writing, data management etc. Advanced training to US and below. Refresher/ induction training should be provided for all new joiners.
	Government documentation (noting, drafting, cabinet notes, parliamentary answers, reports, Memorandum of Understanding etc.), reporting for parliamentary procedures, questions, and RTI queries	<ul style="list-style-type: none"> Trainings on Government documentation, protocols, processes, etc. should be provided to all staff members. Trainings to be provided to all officers in positions and refresher/ induction trainings to be conducted for new joiners.
	Financial procedures/ GFR/ Bill clearances/ PFMS	<ul style="list-style-type: none"> Basic knowledge of GFR/ Financial bills and operation of PFMS portal should be provided to all new joiners and other officers in position.
	GRM (Grievance Redressal Mechanism), CPGRAMs and INGRAMs Portals	<ul style="list-style-type: none"> Trainings on portals should be provided as part of induction/ refresher trainings to increase functional efficiency of the staff members.
	Government procurement protocols, processes, and tools (RFP, Tender Evaluation, Tender Award, Government e Marketplace - GeM) etc.)	<ul style="list-style-type: none"> Trainings on Government documentation, protocols, processes, understanding of tender, GeM portals etc. should be provided to all staff members. Trainings to be provided to all officers in positions and refresher/ induction trainings to be conducted for new joiners.
Behavioural	Verbal communication; Liaisoning and Negotiation skills	<ul style="list-style-type: none"> Effective communication plays a crucial role in handling day to day ministerial activities in both written and verbal form. It encourages effective dialogue. Negotiation, understanding on perspectives, building relationships and smooth transfer of knowledge. Hence, communication trainings should be provided to all officer up to DS level.
	Multitasking and time management	<ul style="list-style-type: none"> Trainings on multitasking and time management to be conducted for all officials to maintain healthy work life balance. Advanced training for senior officers.
	Administrative and managerial skills	<ul style="list-style-type: none"> To run an efficient team, training should be provided for enhancing the managerial skills of the section staff. It will increase the sense of decision making, communication, strategic planning etc. Senior officials such as DS and above should be provided with

		<p>advanced level trainings to upskill.</p> <ul style="list-style-type: none"> • Induction / Refresher training to be provided for new joiners.
	Stakeholder and people management	<ul style="list-style-type: none"> • Trainings to handle and negotiate with stakeholders both internal and external shall be provided to the staffs for ease knowledge transfer through means of communication.
	Gender sensitization and anti-sexual harassment	<ul style="list-style-type: none"> • Such interpersonal trainings should be conducted at regular intervals and these trainings should be mandatory for all designations.
	Organizational skills (such as planning, delegation, knowledge of key responsibility areas, goal setting, team building etc.)	<ul style="list-style-type: none"> • Regular upskilling required to enhance organizational skills for all employees (particularly senior officers) to delegate matters effectively,
	Health and well-being, and stress management	<ul style="list-style-type: none"> • Trainings on balancing health to be provided to officers of all level.
	Adaptation to new skills and methodologies	<ul style="list-style-type: none"> • Regular upskilling is essential to pace up with the existing technological advancements and hence trainings should be provided to all officials to increase adaptability to new technologies and their operating procedures.

2.6.2.9. Transport Research Wing (TRW)

TRW is involved in collection, compilation dissemination and analysis of data on Roads, Road Transport, Road Accidents, i.e. subjects which pertains to the Ministry of Road Transport & Highways. Besides it is responsible for rendering necessary research and data support to the various wings of Ministry of Road Transport and Highways for policy planning in transport sector.

Figure 35: Organogram - TRW

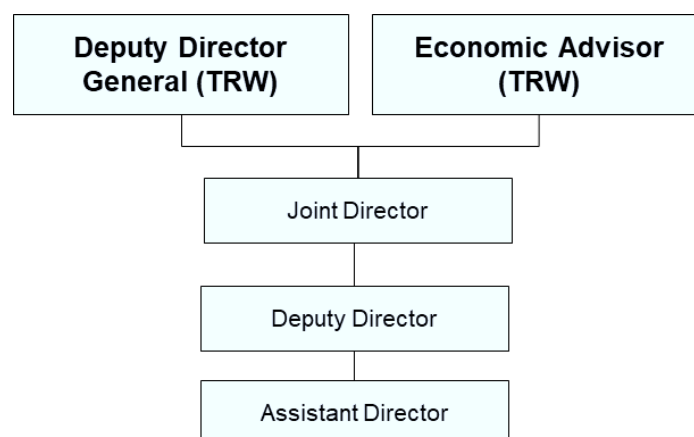

Key focus areas

- Data collection from relevant agencies
- Publication of Annual Yearbooks

Role of TRW

- Collection of data on the road and road transport sectors including road accidents
- Compilation and analysis of data on motor vehicles, structure and rates of motor vehicle taxes from various source agencies

- Publication of following year books –
 - Basic Road Statistics of India
 - Road Transport Year Book
 - Performance of State Road Transport Undertaking
 - Road Accidents in India

Roles and functions of various officer levels:

Designation	Role and functions
Deputy Director General (DDG)	In-charge overall administration of the section and the following on key tasks on a regular basis. <ul style="list-style-type: none"> ○ Supervising all data related matters for the Ministry ○ Approvals for final publications of the annual reports ○ Dealing with policy approvals and sanctions ○ Stakeholder management both internal and external ○ Hiring of contractual staff and consultants
Economic Advisor	Handling matters related to economics and statistical subjects. Some of the key tasks involve – <ul style="list-style-type: none"> ○ Deriving statistical inferences ○ Reviewing reports ○ Review and approvals on final publications of the annual reports ○ Preparing research reports on economic matters ○ Dealing with policy approvals and sanctions ○ High level data analysis ○ Stakeholder management both internal and external
Joint Director (JD)	Provides administrative support to the division. Major key roles include closely monitoring day to day tasks. <ul style="list-style-type: none"> ○ Matters related to data desilisation. ○ Reviewing matters related to inputs/information to MoSPI and other state government and central government agencies. ○ Assisting Publication of annual reports ○ High level data analysis ○ Stakeholder Management both internal/external
Deputy Director (DD)	Assists in other technical activities related to TRW. Some key tasks include – <ul style="list-style-type: none"> ○ Assisting Publication of annual reports – “Basic Road Statistics of India” (BRS) ○ Work related to iRAD/eDAR & monthly road accident data and other statistical matters. ○ Matters associated with Black spots. ○ Addressing issues related to NDSAP, WHO, DGQI ○ Dissemination of information/data for “Road Accidents in India” ○ Court cases / Committees on road accidents ○ Matters related to General Administration / coordination. ○ Stakeholder Management both internal / external
Assistant Director (AD)	Assists in the administrative tasks related to day-to-day activities and provides technical and administrative support. Key tasks include: <ul style="list-style-type: none"> ○ Collection, compilation, and analysis of data and ○ Report writing of publication i.e., "Road Accident in India", "Basic Road Statistics of India", "Road Transport Yearbook" and "Performance of State Road Transport Undertakings". ○ Providing inputs for Economic Survey to Department of Economic Affairs, Ministry of Finance. ○ Providing inputs/information to MoSPI and other state government and central government agencies. ○ Collection of black spot data from police department of all the States/UTs.

Based on the roles and functions, the domain competencies identified across various officer levels are:

Domain Competencies	DDG	EA	JD	DD	AD
Data visualization (graphical representation of data) with					

Domain Competencies	DDG	EA	JD	DD	AD
new tools and techniques for better data interpretation					
Data collection, compiling, and circulating time series data					
Statistics, economics, and data modelling					
Laws & regulations / policy matters related to roads, transport sector and relevant amendments					
Managing annual manual of the division - namely Basics Road Statistics, Road Transport Yearbook, Road Accidents in India, and Review of Performance of State Road Transport Undertaking					

Level of intervention as per competency need assessed

High	Moderate	Low
------	----------	-----

The behavioural and functional competencies mapped for the section are the follows:

Type	Competencies	DDG	EA	JD	DD	AD
Functional	Central Portals (e-office, NIC Portal, Grievance Portal, VIP Portal, Bhoomirashi Portal and any other relevant portal)					
	MS Office (Word, PowerPoint, Excel)					
	Government documentation (noting, drafting, cabinet notes, parliamentary answers, reports, Memorandum of Understanding etc.), reporting for parliamentary procedures, questions, and RTI queries					
	Financial procedures/ GFR/ Bill clearances/ PFMS					
	GRM (Grievance Redressal Mechanism), CPGRAMs and INGRAMs Portals					
	Government procurement protocols, processes, and tools (RFP, Tender Evaluation, Tender Award, Government e Marketplace - GeM) etc.)					
	Judicial Pronouncement and Restrictions, Audit Paras and Court Cases					
Behavioural	Verbal communication; Liaisoning and Negotiation skills					
	Multitasking and time management					
	Administrative and managerial skills					
	Stakeholder and people management					
	Gender sensitization and anti-sexual harassment					

Type	Competencies	DDG	EA	JD	DD	AD
	Organizational skills (such as planning, delegation, knowledge of key responsibility areas, goal setting, team building etc.)					
	Health and well-being, and stress management					
	Adaptation to new skills and methodologies					

Level of intervention as per competency need assessed

High	Moderate	Low
------	----------	-----

Training Need Assessment

Type	Competency	Training Need Assessment
Domain	Data visualization (graphical representation of data) with new tools and techniques for better data interpretation	<ul style="list-style-type: none"> Trainings various business tools to upskilling of the team. Advanced training required for DD & AD
	Data collection, compiling, and circulating time series data	<ul style="list-style-type: none"> New joiners should be given refresher/ induction training on the same. Advanced training for junior staff (DD & AD)
	Statistics, economics, and data modelling	<ul style="list-style-type: none"> Refresher/ induction training to be provided to new joiners and senior officers in position.
	Laws & regulations / policy matters related to roads, transport sector and relevant amendments	<ul style="list-style-type: none"> Trainings on laws related to transport sector to be provided to senior officials. Regular refresher training to be provided to existing staff.
	Managing annual manual of the division - namely Basics Road Statistics, Road Transport Yearbook, Road Accidents in India, and Review of Performance of State Road Transport Undertaking	<ul style="list-style-type: none"> Trainings on project management to be provided for better utilisation of resources, adaptability, more time management, and better on-site operations etc
Functional	Central Portals (e-office, NIC Portal, Grievance Portal, VIP Portal, Bhoomirashi Portal and any other relevant portal)	<ul style="list-style-type: none"> Trainings on portals should be provided as part of induction/ refresher trainings to increase functional efficiency of the staff members.
	MS Office (Word, PowerPoint, Excel)	<ul style="list-style-type: none"> Trainings on MS office should be provided for better documentation, report writing, data management etc. Refresher/ induction training should be provided for all new joiners
	Government documentation (noting, drafting, cabinet notes, parliamentary answers, reports, Memorandum of Understanding etc.), reporting for parliamentary procedures, questions, and RTI queries	<ul style="list-style-type: none"> Trainings on Government documentation, protocols, processes, etc. should be provided to JD & below. Refresher/ induction trainings to be conducted for new joiners.
	Financial procedures/ GFR/ Bill clearances/ PFMS	<ul style="list-style-type: none"> Basic knowledge of GFR/ Financial bills and operation of PFMS portal should be provided to all new joiners and existing officers in position.
	GRM (Grievance Redressal Mechanism), CPGRAMs and INGRAMs Portals	<ul style="list-style-type: none"> Trainings on portals should be provided as part of induction/ refresher trainings to increase functional efficiency of all staff members.
	Government procurement protocols, processes, and tools (RFP, Tender Evaluation, Tender Award, Government	<ul style="list-style-type: none"> Trainings on Government documentation, protocols, processes, understanding of tender, GeM portals etc. should

	e Marketplace - GeM) etc.)	<p>be provided to all staff members.</p> <ul style="list-style-type: none"> • Trainings to be provided to all officers in positions and refresher/ induction trainings to be conducted for new joiners.
	Judicial Pronouncement and Restrictions, Audit Paras and Court Cases	<ul style="list-style-type: none"> • Basic trainings to handle matters related to court and other PMO related Q&A should be provided to all officers. • Trainings should be made mandatory.
Behavioural	Verbal communication; Liaisoning and Negotiation skills	<ul style="list-style-type: none"> • Advanced communication trainings should be provided across all designation levels, since TRW interacts a lot with other MDOs and State Departments for data collection and dissemination
	Multitasking and time management	<ul style="list-style-type: none"> • Trainings on multitasking and time management to be conducted for senior officials and new joiners to maintain healthy work life balance.
	Administrative and managerial skills	<ul style="list-style-type: none"> • Officials JD & Below should be provided with advanced level trainings to upskill. • Induction / Refresher training to be provided for new joiners.
	Stakeholder and people management	<ul style="list-style-type: none"> • Advanced Trainings to handle and negotiate with stakeholders both internal and external shall be provided to the staffs for ease knowledge transfer through means of communication.
	Gender sensitization and anti-sexual harassment	<ul style="list-style-type: none"> • To promote inclusivity, enhance organizational culture, prevent harassment at workplace, regular trainings should be provided on sensitive topics such as sexual harassment. • Such interpersonal trainings should be conducted at regular intervals and these trainings should be mandatory for all designations.
	Organizational skills (such as planning, delegation, knowledge of key responsibility areas, goal setting, team building etc.)	<ul style="list-style-type: none"> • Regular upskilling required to enhance organizational skills for all employees to delegate matters effectively. Advanced training required for all officers.
	Health and well-being, and stress management	<ul style="list-style-type: none"> • Trainings on balancing health to be provided to officers of all levels.
	Adaptation to new skills and methodologies	<ul style="list-style-type: none"> • Regular upskilling is essential to pace up with the existing technological advancements and hence trainings should be provided to all officials to increase adaptability to new technologies and their operating procedures.

2.6.2.10. Indian Academy of Highway Engineers (IAHE)

IAHE is headed by Director. Its core aim is to provide trainings to technical professionals on various courses ranging from domain specific skills to Management Development programs. It trains professionals who are new to the sector as well as the experienced officers. It promotes cooperation and knowledge transfer for both national and international stakeholders. It has other supporting technical staff too such as SE, EE, AEE etc.

Figure 36: Organogram – IAHE

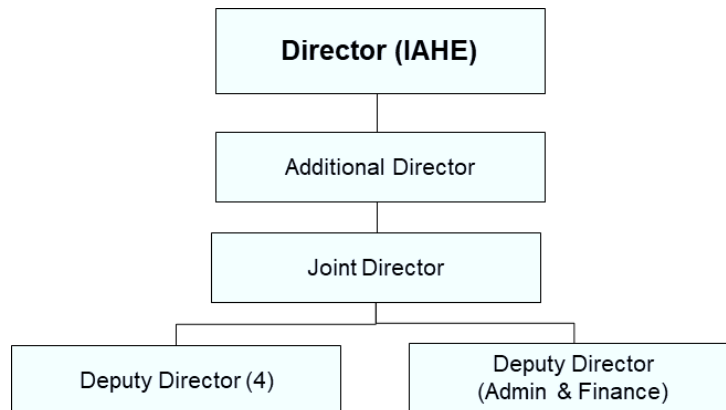

Key focus areas

- Training of Officers under MoRTH

Role of IAHE

- Impart training to professionals of Highway Sector at entry level and during service at different levels of Central & State Govts., Public and Private sectors.
- Help highway sector engineers build up character and develop an all-round personality as a part of Human Resource Development.
- Assist various organizations in developing their training institutes and training of their faculty.
- Promote co-operation and foster exchange of knowledge, ideas and experience in all the sphere of highway engineering among engineers in India and Abroad.
- Impart training to Highway Professionals from various Afro-Asian countries, Countries under SAARC, Technical Cooperation Scheme (TCS) Colombo Plan, India Africa Forum Summit (IAFS), India Technical & Economic Cooperation (ITEC), ASEAN-India Fund (AIF).

Roles and functions of various officer levels:

Designation	Role and functions
Director	<p>In-charge overall administration of the section and the following on key tasks on a regular basis.</p> <ul style="list-style-type: none"> ○ Provide strategic leadership and overall management of IAHE, ensuring the effective implementation of its training programs and objectives. ○ Develop and review training modules for professionals in the highway sector at entry and various service levels. ○ Foster collaboration with Central and State Governments, Public and Private sectors to enhance the quality of training and human resource development in the highway engineering sector. ○ Promote international cooperation by facilitating the exchange of knowledge, ideas, and experiences in highway engineering with professionals both in India and abroad. ○ Represent IAHE in national and international forums, contributing to the advancement of highway engineering education and practices.
Additional Director (AD)	<ul style="list-style-type: none"> ○ Assist the Director in formulating and implementing the strategic vision and policies of IAHE. ○ Oversee the development of training programs aimed at building the character and all-round personality of highway sector engineers. ○ Collaborate with various organizations to support the establishment and enhancement of their training institutes and the training of their faculty. ○ Contribute to the promotion of knowledge exchange and cooperation within the highway engineering community at national and international levels. ○ Play a key role in organizing training programs for professionals from Afro-Asian countries, SAARC, Colombo Plan, IAFS, ITEC, and ASEAN-India Fund.

Designation	Role and functions
Joint Director (JD)	<ul style="list-style-type: none"> ○ Manage specific training programs and initiatives within IAHE, ensuring their alignment with organizational goals. ○ Coordinate with internal and external stakeholders to enhance the quality and relevance of training modules. ○ Support the Director and Additional Director in fostering collaboration and knowledge exchange in the field of highway engineering. ○ Oversee the training of highway professionals from various countries under international cooperation schemes. ○ Contribute to the continuous improvement of training methodologies and curriculum
Deputy Director (DD)	<ul style="list-style-type: none"> ○ Assist in the development and execution of training programs for professionals in the highway sector. ○ Coordinate with internal teams to ensure the smooth delivery of training modules and workshops. ○ Support the Additional Director and Joint Director in fostering collaboration with organizations for the establishment and improvement of training institutes. ○ Play a role in promoting cooperation and knowledge exchange among highway engineers both nationally and internationally. ○ Contribute to the planning and execution of training programs for professionals from different countries participating in international cooperation schemes. ○ Explore opportunities to leverage technology for improved financial management, reporting, and administrative functions.
Deputy Director (Admin & Finance)	<ul style="list-style-type: none"> ○ Oversee the financial operations of IAHE, including budgeting, financial planning, and expenditure control. ○ Prepare annual budgets, monitor financial performance, and provide regular financial reports to the Director and other relevant authorities. ○ Manage administrative functions, including personnel management, facility maintenance, and procurement activities. ○ Implement and maintain administrative policies and procedures to ensure smooth day-to-day operations. ○ Coordinate with internal and external auditors to facilitate audits and implement recommendations for process improvements.

Based on the roles and functions, the domain competencies identified across various officer levels are:

Domain Competencies	Director	AD	JD	DD	DD (Admin & Fin)
Training needs assessment and identification of training requirements					
Capacity building of individual and organization					
Preparation of training calendars, training, plan, co-ordination with trainers and experts					
Preparation of curriculum for various trainings & certifications					
Promotion of training activities and registration of candidates for training programs					
International cooperation on knowledge sharing and training					
Event management and program management					
Training tools, techniques for classroom and online training					

Level of intervention as per competency need assessed

High

Moderate

Low

The behavioural and functional competencies mapped for the section are the follows:

Type	Competencies	Director	AD	JD	DD	DD (Admin & Fin)
Functional	Central Portals (e-office, NIC Portal, Grievance Portal, VIP Portal, Bhoomirashi Portal and any other relevant portal)					
	MS Office (Word, PowerPoint, Excel)					
	Financial procedures/ GFR/ Bill clearances/ PFMS					
	GRM (Grievance Redressal Mechanism), CPGRAMs and INGRAMs Portals					
	Emerging Technologies and knowledge management					
	Government procurement protocols, processes, and tools (RFP, Tender Evaluation, Tender Award, Government e Marketplace - GeM) etc.)					
Behavioural	Verbal communication; Liaisoning and Negotiation skills					
	Multitasking and time management					
	Administrative and managerial skills					
	Stakeholder and people management					
	Gender sensitization and anti-sexual harassment					
	Organizational skills (such as planning, delegation, knowledge of key responsibility areas, goal setting, team building etc.)					
	Health and well-being, and stress management					
	Adaptation to new skills and methodologies					

Level of intervention as per competency need assessed

High

Moderate

Low

Training Need Assessment

Type	Competency	Training Need Assessment
Domain	Training needs assessment and identification of training requirements	<ul style="list-style-type: none"> Intermediate to advanced level training for the AD & above.
	Capacity building of individual and organization	<ul style="list-style-type: none"> Intermediate to advanced level training curriculum to be designed for capacity building of the JD & above.
	Preparation of training calendars, training, plan, co-ordination with trainers and experts	<ul style="list-style-type: none"> New joiners should be given refresher/ induction training on preparation of training needs calendar, coordination and other relevant skills. (for JD & below)
	Preparation of curriculum for various trainings & certifications	<ul style="list-style-type: none"> Intermediate to advanced level training curriculum to be designed on various trainings and certifications. (for JD & below)
	Promotion of training activities and registration of candidates for training programs	<ul style="list-style-type: none"> Intermediate to advanced level training curriculum to be designed. (for AD & below)
	International cooperation on knowledge	<ul style="list-style-type: none"> Trainings should be conducted for all officers on international

	sharing and training	<p>cooperation.</p> <ul style="list-style-type: none"> Advanced level training for senior officers (AD & above)
	Event management and program management	<ul style="list-style-type: none"> Trainings on project management to be provided for event management to Staff (JD & below)
	Training tools, techniques for classroom and online training	<ul style="list-style-type: none"> Trainings various business tools to upskilling of the team and classroom leanings for officers (for JD & DDs)
Functional	Central Portals (e-office, NIC Portal, Grievance Portal, VIP Portal, Bhoomirashi Portal and any other relevant portal)	<ul style="list-style-type: none"> Trainings on portals should be provided as part of induction/ refresher trainings to increase functional efficiency of the staff members.
	MS Office (Word, PowerPoint, Excel)	<ul style="list-style-type: none"> Trainings on MS office should be provided for better documentation, report writing, data management etc. Refresher/ induction training should be provided for all new joiners. Advanced training for JD & below
	Financial procedures/ GFR/ Bill clearances/ PFMS	<ul style="list-style-type: none"> Trainings on Government documentation, protocols, processes, etc. should be provided to all staff members. Trainings to be provided to all officers in positions and refresher/ induction trainings to be conducted for new joiners.
	GRM (Grievance Redressal Mechanism), CPGRAMs and INGRAMs Portals	<ul style="list-style-type: none"> Basic knowledge of GFR/ Financial bills and operation of PFMS portal should be provided to all new joiners and other officers in position.
	Emerging Technologies and knowledge management	<ul style="list-style-type: none"> Trainings on emerging technologies and knowledge management for all officers.
	Government procurement protocols, processes, and tools (RFP, Tender Evaluation, Tender Award, Government e Marketplace - GeM) etc.)	<ul style="list-style-type: none"> Trainings on Government documentation, protocols, processes, understanding of tender, GeM portals etc. should be provided to all staff members. Trainings to be provided to all officers in positions and refresher/ induction trainings to be conducted for new joiners.
Behavioural	Verbal communication; Liaisoning and Negotiation skills	<ul style="list-style-type: none"> Advanced communication trainings for senior officers (JD & above)
	Multitasking and time management	<ul style="list-style-type: none"> Trainings on multitasking and time management to be conducted for senior officials (JD & above).
	Administrative and managerial skills	<ul style="list-style-type: none"> Officials (AD & below) should be provided with advanced level trainings to upskill.
	Stakeholder and people management	<ul style="list-style-type: none"> Officials (AD & below) should be provided with advanced level trainings to upskill.
	Gender sensitization and anti-sexual harassment	<ul style="list-style-type: none"> To promote inclusivity, enhance organizational culture, prevent harassment at workplace, regular trainings should be provided on sensitive topics such as sexual harassment. Such interpersonal trainings should be conducted at regular intervals and these trainings should be mandatory for all designations.
	Organizational skills (such as planning, delegation, knowledge of key responsibility areas, goal setting, team building etc.)	<ul style="list-style-type: none"> Regular upskilling required to enhance organizational skills for all employees to delegate matters effectively.
	Health and well-being, and stress management	<ul style="list-style-type: none"> Trainings on balancing health to be provided to officers of all level.
	Adaptation to new skills and methodologies	<ul style="list-style-type: none"> Advanced trainings should be provided to all officials to increase adaptability to new technologies and their operating procedures.

3. Review of Existing Capacity

3.1. Existing Training Calendar

Several training initiatives have been conducted before as well for the capacity building of the Ministry of Road Transport & Highways. Indian Academy of Highway Engineers (IAHE) along with other educational institutes like premium IITs/IIMs have supported in the preparation of the training modules and calendars. IAHE prepares an annual calendar of various trainings with respect to various verticals of the Ministry. Most of the trainings at IAHE are focused for technical upskilling and enhancing knowledge in the good industry practices. Special courses are conducted for newly appointed trainee officers for technical domain such as AEE, EE, SE etc. Details such as training dates, timings, venue are provided in the training calendar. Some of the key training areas of IAHE include –

- Road safety
- Highway engineering
- Construction management
- Planning, Designing and
- Other Refresher training modules for existing officers.

Similar to Indian Academy of Highway Engineers (IAHE) is the Institute of Secretariat Management (ISTM) organizes a training calendar on annual basis for all government employees ranging from Group A officers to all others. The trainings are conducted for various domain centric topics and officers can register themselves for those training relevant to their work or any other related to enhancement of behavioral and functional skills.

Mode of the trainings and duration can differ depending upon the course content. Trainings can either be conducted on online mode, offline mode or on hybrid model as well. Some of the relevant trainings on ISTM include –

- *Financial Planning*
- *Administrative trainings*
- *Leadership training courses such as Management etc.*
- *Budget and Planning*
- *Technical trainings such as MS Office, and other relevant software's etc.*

The annual training calendar of Indian Academy of Highway Engineers (IAHE) is given in the figure below:

Figure 37: Training Calendar of IAHE - FY 2023-24

 Indian Academy of Highway Engineers (IAHE) Ministry of Road Transport & Highways, Govt. of India				Training Calendar for the year 2023-2024																					
S. No.	Name of Training Programme	Training Period	Participation Level / Equivalent to	Apr 2023 Dates	May 2023 Dates	Jun 2023 Dates	Jul 2023 Dates	Aug 2023 Dates	Sep 2023 Dates	Oct 2023 Dates	Nov 2023 Dates	Dec 2023 Dates	Jan 2024 Dates	Feb 2024 Dates	Mar 2024 Dates										
1	Modern Topographic Surveying Methods	5 days	EE/AE/JE					7-11				4-8													
2	Road Safety Engineering & Auditing	5 days	SE/EE/AE							9-13					11-15										
3	Geometrics Design of Highways using CAD Tools	5 days	EE/AE						11-15				8-12												
4	Design, Construction & Maintenance of Flexible Pavement	5days	EE/AE/JE		15-19				4-9																
5	Design, Construction & Maintenance of Rigid Pavement	5 days	EE/AE/JE		22-26				18-22																
6	Design of Box Culvert, RCC Voided Slab, RCC Slab, T-Beam Girder Bridge on Open Foundation	5 days	EE/AE			19-23								5-9											
7	Design of PSC (Cast-in-Situ, Precast Girder with Cast-in-Situ Slab) Superstructure Bridge on Pile/Well Foundation	11 days	EE/AE			12-23						11-22													
8	Preparation of Detailed Project Report for Highway Projects including Bridges	6 days	EE/AE/JE				3-8																		
9	Engineering, Procurement and Construction (EPC) Contract for Highway Projects	3 days	CE/SE/EE/AE					16-18					15-17												
10	Public Private Partnership (PPP) Contract for Highway Projects	5 days	CE/SE/EE/AE							9-13															
11	Pre-construction Activities for Highway Projects	3 days	EE/AE/JE			26-28								6-8											
12	Highway Development & Maintenance Investment Decision	3 days	CE/SE/EE/AE									4-6													
13	Construction, Quality Control & Maintenance of Structures	6 days	EE/AE/JE				3-8			9-14															
14	Planning, Design, Construction & Maintenance of Hill Roads	5 days	EE/AE/JE				24-28																		
15	Refresher Course for EEs	6 days	EE							30-04															
16	Refresher Course for SEs	5 days	SE										15-19												
17	Management Development Programme for Mid-level Officers (EE & SE)	3 days	SE/EE							3-5															
18	Management Development Programme for Senior Officers (CE & E-in-C)	2 days	E-in-C/CE									26-27													
19	Asset Management for Highways	5 days	SE/EE/AE				10-14							19-23											
20	Contract Management & Dispute Resolution in Highway Projects	5 days	CE/SE/EE/AEE	10-14						30-03															
21	Design & Construction of High Embankments with Free Slope/RE wall/Retaining Wall, Ground Treatment of Soft Soil	5 days	EE/AE/JE				17-21				20-24														
22	Surface & Subsurface Drainage Management	3 days	EE/AE/JE						4-6																
23	Intelligent Transportation System Applications for Highways	3 days	SE/EE/AE					21-23																	
24	Operation, Maintenance & Tolling of Highways	3 days	EE/AE/JE							4-6				13-15											
25	Material Testing Procedure & hands on practices	5 days	AE/JE							16-20															
26	Use of Waste materials in Highway Construction	3 days	EE/AE/JE								6-8														
27	Design, Construction, Maintenance and Operation of Tunnels	3 days	SE/EE/AE			19-21								13-15											
28	Slope Management in Hill Roads & Landslide Mitigation	3 days	EE/AE/JE		08-10				25-27																
29	The Control of National Highways (Land & Traffic)	2 days	EE/AE/JE												4-5										
30	Design, Construction, Maintenance and Operation of Expressway	5 days	SE/EE/AE		8-12							11-15													
31	Project Management	4 days	SE/EE/AE					21-24				26-29			11-14										
32	Good Construction Practices	5 days	SE/EE/AE					28-1			20-24														
33	Expansion Joints	2 days	SE/EE/AE			1-2																			
Fee for Indian Participants			Fee for Foreign Participants			Fee is including accommodation on twin sharing basis and meals, payable to IAHE, Bank of India a/c 712212100000311, IFSC: BKID0007122, GSTIN: 09AABA12196K1ZD, PAN No AABA12196K, in advance for Registration.																			
MoRTH, NHAI, NHIDCL, BRO, MES, State PWDs, CPWD, Indian Railways, Central/State PSUs/Corps/Universities, etc.			Consultants, Contractors and other Private Sector Organizations													INR 10,000 per participant per day + 18% GST (payable in USD)									
Nil			INR 5000/participant/day + 18% GST																						
Nominations must reach at least 15 days before start of the programme and ensure participation of nominated officers. Online registration may be made on hyperlink of the programme. Tailor-made sponsored training programmes as per the requirements of Central/State Govt. Departments and Private Sector Organizations are also organized on request. Please contact Director, IAHE, A-5, Sector-62, Noida-201309 (UP), India at Email iahe-training@gov.in, director-iahe@gov.in, www.iahe.org.in for details.																									

3.2. Root Cause Analysis

After the stakeholder discussions, the following issues were identified at an organizational level –

Table 4: Root Cause Analysis of Competency Gap

S. No	Gap Identified	Remarks
1.	Lack of Comprehensive Training Programs	<ul style="list-style-type: none"> • Many training programs are not up to date with industry best practices, with frequent refresher courses for continuous learning. • Officers have limited access/ knowledge of online courses and resources which they can use to enhance their capacity. • Most of the trainings are conducted by IAHE, which has limited capacity. There is a need to increase collaboration with other agencies/ institutes to provide functional & domain training to officers. • Mandatory trainings for enhancement of functional and behavioral skills shall be conducted regularly for the staff • Trainings to maintain an effective work life balance and learning of best practices such as meditation techniques to increase focus, resilience and reduce stress
2.	Limited Manpower	<ul style="list-style-type: none"> • Frequent officer turnover, both intra and inter Department/ Ministry, disrupts training and development efforts • Existing officers often handle multiple responsibilities, leading to overwork and reduced time availability for competency development initiatives. • Officers are handling multiple tasks may find it challenging to focus on developing specialized competencies, leading to diluted skill sets. • Unclear lines of accountability often lead to inefficiencies and a lack of ownership of initiatives and activities. • Inconsistent allocation of resources to various projects impacts project prioritization and completion.
3.	Ineffective Knowledge Sharing	<ul style="list-style-type: none"> • Officers have limited exposure to cross-functional roles and responsibilities. • Limited constructive performance feedback, hindering competency development. • Legacy systems/ processes and technology/ digital solutions impede data sharing, analysis, and collaboration. • More trainings on project management shall be conducted to improve peer-to-peer on job learnings • Group learning culture should be promoted to enhance leadership values
4.	Inadequate Succession Planning	<ul style="list-style-type: none"> • Lack of Capacity Development Plan to address officers' unique competency needs. • Lack of induction programs for officers to enable them to understand organizational culture, their role and technical aspects of the activities undertaken.
5.	Ineffective Performance Management	<ul style="list-style-type: none"> • Overreliance on top-down decision-making leads to a lack of agility and responsiveness to changing needs. • Lack of clear performance metrics and key performance indicators (KPIs). • Insufficient emphasis on creating actionable development plans based on performance evaluations. • Proper feedback mechanism shall be introduced for continuous improvements among the staff members • Clear goal setting in line with individual and organizational goals

3.3. Recognition/ Motivation

The table below lists some of the incentives/ motivations that can help MoRTH cultivate a skilled and motivated workforce committed to continuous improvement include –

Table 5: List of identified incentives/ motivations

S. No	Incentives / Motivation	Description
1.	Professional Development Opportunities	<ul style="list-style-type: none"> • Providing customized training programs/ workshops and courses to enhance skills and knowledge relevant to their roles and responsibilities. • Assessment of staff members needs aspirations to learn and grow and setting suitable opportunities to learn • Creating job rotational and cross vertical opportunities for the employees • Introduction to more online learning resources
2.	Career advancement pathways	<ul style="list-style-type: none"> • Creating a clear career progression plan for each officer that reward them for acquiring the required and new skills and qualifications
3.	Financial incentives	<ul style="list-style-type: none"> • Providing bonuses, scholarships, and financial rewards (Gift Coupons etc.) for completing capacity building activities successfully.
4.	Recognition and awards	<ul style="list-style-type: none"> • Acknowledge and recognize their achievement in capacity building initiatives through awards and organization-wide recognition
5.	Flexible work arrangements	<ul style="list-style-type: none"> • Allow flexible work arrangements to accommodate officers' participation in training and development programs. • More trainings based on self-paced learning model to increase participation along with work commitments
6.	Mentorship and support	<ul style="list-style-type: none"> • Align mentors or coaches for officers who guide them in their capacity development journey and offer them advise and encouragement.

4. Enabling Environment

To study the enabling environment of the Ministry of Road Transport and Highways (MoRTH), it is essential to study the current structure for proposing recommendations for its enhancement, particularly in terms of organizational processes, protocols, and capacity building. The current state analysis includes organizational process, people management, adherence to relevant protocols and guidelines, analysis of gaps, and propose interventions as per relevant gaps.

This report provides a comprehensive overview of organizational processes and functions, encompassing personnel management, as well as the evaluation of hard and soft infrastructure. The inputs for this section are based on consultations with key stakeholders within the MoRTH. Proposed interventions were developed through focused group discussions and individual consultations with senior officers of the Ministry. As outlined in the subsequent section, the procedures and protocols within various domains of the Ministry align with widely accepted guidelines for central government Ministries and Departments (MDOs).

4.1. Organizational Processes and Functioning

4.1.1. Business Processes, Protocols and SOPs followed

The operational framework of India's government entities must adapt to the evolving landscape of the private sector and the global competition, necessitating a continuous enhancement of structures, processes, and protocols. This evolution is crucial not only for sustaining growth but also for attracting and retaining top talent. Achieving this requires an ongoing commitment to upgrading efficiency in handling information, expediting issue resolution, and maintaining quality while adhering to established procedures.

In line with this imperative, various departments of the Government of India (GoI) have undertaken initiatives over the past decade, exemplified by the introduction of the e-Office system. This comprehensive suite comprises applications such as the File Management System (eFile), Knowledge Management System (KMS), Work from Anywhere (WAW) Portal, and the Smart Performance Appraisal Report Recording Online Window (SPARROW).

Additionally, the Department of Administrative Reforms and Public Grievances (DARPG), serving as a nodal agency for organizational methodologies, has delineated procedures for secretariat work in the Central Secretariat Manual of Office Procedure (CSMOP). MoRTH adheres to this guidebook for its processes and protocols. The CSMOP procedures strive to strike a balance between considerations of speed, quality, transparency, and propriety. Given the dynamic nature of governance, this equilibrium cannot be rigidly fixed and requires periodic reassessment. The adoption of these procedures follows a careful examination of methods and practices in various Ministries, Departments, and Offices of the Government of India.

The CSMOP not only outlines essential procedures for efficient information and file management but also allows for flexibility through the issuance of departmental instructions. These instructions can supplement or modify, within broad limits, the prescribed procedures to accommodate special conditions and requirements. Each department, including MoRTH, is encouraged to establish suitable arrangements, including inspections, to ensure compliance with the manual and departmental instructions.

The CSMOP provides comprehensive guidelines across various aspects, including:

- Functionaries and Functions
- Decision Making in Government
- Management of Document/DAK Receipts
- File Management System
- Guidelines on Noting

- Communication, Forms, Channels, and Procedure
- Guidelines on Drafting of Communications
- Records Management
- Knowledge Management
- Monitoring of Timely Disposal
- Security of Official Information and Documents
- Annual Action Plan & Citizen's/Client's Charter e-Office Digitization Framework
- Inspection

While this section delves into the specific business processes, protocols, and SOPs followed in MoRTH, it's important to note that these practices are commonly observed across various Ministries and Departments. The subsequent section will focus on administrative processes, operating procedures, internal regulations, and policies, encompassing performance management systems, employee management, and capacity-building mechanisms.

4.1.2. Personnel Management

Similar to business processes and SOPs for business functions, the Ministry undertakes personnel management, as per the commonly followed guidelines existent across the government functionary. The personnel management can be broadly divided into performance management, employee management and capacity building mechanism, detailed as below:

Performance Management

Performance Management in Ministry is an ongoing process that involves collaboration between supervisors and employees. This process is monitored through a structured performance management system, which includes the creation of Annual Performance Assessment Reports (APAR). The format of the report may vary based on the officer's level and seniority.

As part of APAR the broad parameters for assessment of performance include:

- Work output: includes accomplishment of work allocated, quality of output, performing unforeseen tasks and analytical ability;
- Functional competency: includes working knowledge of rules, regulation, procedures around the function and ability to apply them correctly, strategic planning ability, decision making ability, coordination ability, ability to motivate and develop subordinates and take initiative;
- Personal attributes: includes attitude to work, sense of responsibility, maintaining discipline, communication skills, leadership qualities, capacity to work in a team, capacity to adhere to time schedule, interpersonal relations, overall bearing, and personality.

The procedure to prepare the APAR are as follows:

- At the beginning of the year, the Reporting Officer, a Senior Officer, sets targets for each Junior Officer.
- The concerned government officer (reportee) initiates the APAR, providing a brief description of duties, set targets, achievements, shortfalls, and encountered constraints.
- The Reporting Officer assesses performance and submits the assessment to a Reviewing Officer, a senior officer, for further review.
- The dual-level assessment by Reporting and Reviewing Officers ensures objectivity and fairness.

The processes to complete the APAR and its final taking on record are as follows:

- i. The Annual Performance Assessment Report (APAR), encompassing the overall grade and integrity assessment, is communicated to the respective officer, accompanied by remarks from both the Reviewing Officer and the Accepting Authority.
- ii. Upon receiving the APARs, the department responsible for maintaining these records discloses the reports to the officers in question.
- iii. The reportee, or concerned officer, has the opportunity to provide representations against the entries. The final grading is then conducted within fifteen days from the date of receiving the entries in the APAR. Representations are confined to factual observations related to attributes, work output, etc.
- iv. The competent authority reviews the representation, consulting with both the Reporting and/or Reviewing Officer, and impartially decides the matter based on the material provided. This decision is made within a period of thirty days from the date of receiving the representation.
- v. Following due consideration, the competent authority may either reject or accept the representation made by the reportee and adjust the APAR accordingly. The final grading decision of the competent authority is communicated to the concerned officer within fifteen days of receiving the decision from the APAR section¹.

Employee Management

Employee Management at MoRTH encompasses a broad spectrum, including the development, management, and interaction with employees. The primary objective is to equip the employees with the necessary tools and advantages, facilitating the achievement of their individual goals.

Internal Issue Resolution:

Internal issues within the Wings/ Divisions/ Sections are effectively managed and resolved by officers at the Director or Under Secretary level. This proactive approach ensures swift and efficient resolution of challenges that may arise, promoting a harmonious working atmosphere.

Gender Sensitivity and Inclusivity:

The Ministry places a strong emphasis on gender sensitivity and inclusivity. Formal mechanisms are in place to address any issues related to these aspects.

In alignment with the Prevention of Sexual Harassment (PoSH) Act, the Ministry has established an Internal Complaints Committee², chaired by Under Secretary Level officers. The Committee also includes Co-opted member from NGO. This committee is dedicated to addressing matters related to the prevention, prohibition, and redressal of sexual harassment at the workplace. Any women employee of the Ministry with grievance regarding sexual harassment may contact/submit her grievance to the Chairperson/members of the Internal Complaints Committee.

Recognizing the importance of providing a secure platform for women to register complaints related to sexual harassment, Ministry is part of the Sexual Harassment Electronic Box (SHe-Box) initiative. This effort by the Government of India, managed by the Ministry of Women & Child Development, offers a single-window access for women, irrespective of their work status.

Should a female employee encounter challenges in registering a PoSH case with the Internal Complaints Committee, she has the option to register her complaint through the SHe-Box. Upon submission, the complaint is directly sent to the concerned authority with jurisdiction to investigate the matter and take appropriate action.

¹ <https://documents.doptirculars.nic.in/D2/D02ser/BROCHURE-CR.pdf>

² <https://morth.nic.in/sites/default/files/establishment/1-Order-Internal-ICC.pdf>

Capacity Building Mechanism

Ministry regularly conducts mandatory and non-compulsory trainings for its officers at Indian Academy of Highway Engineers (IAHE), iGOT and ISTM. The trainings provided to both technical and administrative officers, include design, construction and maintenance of highways, road safety audit, project management, stress management, In-service training (subject specific) etc. In addition to these, there also certain trainings conducted periodically for all officers at the time of promotions.

Ministry is currently facing manpower crunch, primarily attributed to the transfer of existing officers and introduction of several new work streams. This surge in workload poses challenges for officers to attend requisite training programs, even when these training programs are available and awareness exists.

Despite these constraints, officers have actively participated in training programs held throughout the year. These programs cover a wide array of topics, including public private partnerships, preparation of DPRs, office management, financial management, RTI, records management, good governance, noting & drafting, management services, presentation skills, administrative vigilance, secretariat skills, and e-office, among others.

The challenge of making time for training programs while discharging the demanding roles and responsibilities specifically by officers at senior levels is likely to remain a challenge. Hence the Ministry could consider setting a minimum number of trainings to be completed by senior office of level JS and above, to 2 online training programs and one training program to be attended in person, physical presence.

Additionally, the programs conducted by IAHE are based on its assessment of the needs for the highway sector and the subject of the program can vary from one calendar year to another. Also these programs are design for a batch of approx. 20 participants, Therefore, while the current programs offered by IAHE have been included in this document, the Ministry may consider the nomination of approx. 5 participants for the relevant programs, updated and revised by IAHE from time to time.

Challenges in Training Uptake:

There are some challenges in the training uptake process. These include the absence of a monitoring mechanism or assessments, resulting in a perceived lack of seriousness among participants and low retention of knowledge.

Feedback Mechanism:

One notable observation is the absence of a formal procedure for collecting employee feedback, where officers can express their concerns and provide suggestions for improvement. Recognizing the importance of constructive feedback, exploring ways to implement a robust feedback mechanism to address the evolving needs and training uptake.

4.1.3. Hard & Soft Infrastructure

The Ministry assess the infrastructure availability and gaps on regular basis to understand the current dynamics and takes steps accordingly to facilitate the adequacy of the infrastructure to meets the needs of the employees, furniture ergonomics, physical infrastructure for basic amenities, and supplying other necessary items. Timely reviews are conducted to assess the situation. Apart from the hard physical infrastructure requirements, the Ministry also focus on soft infrastructure such –

- **File Management system** – It is an essential component of the administrative operations. Depending on the volume of work and the nature of topics assigned to the Ministry or its Wings/ Divisions/ Sections, the goals for file management may vary. DARPG has set timeframes for

reference disposal, and the Ministry has shown success in adhering to these timelines even before the stipulated deadlines. The Ministry's adherence to the guidelines set by CSMOP and DARPG showcases its commitment to effective file management practices. By maintaining quantitative goals, adapting to workload variations, and proactively managing file disposal within stipulated timelines, the Ministry ensures efficiency, compliance, and accessibility of records. This approach underscores the significance of systematic file management in maintaining organizational effectiveness and regulatory compliance.

- **e-Office** – The e-office system plays a pivotal role in creating an efficient and transparent digital workspace. Achieving a Simplified and Transparent Working Environment. It has helped in establishing a simplified, responsive, effective, and transparent working environment for all government offices, ensuring a transparent and efficient flow of files within the Ministry. Formal training is provided to specific personnel categories (PPSs, PSs, PAs, Stenos) in the Ministry for timely disposal of files in line with CSMOP guidelines.
- **E-DAR Application** – Ministry has developed Electronic Detailed Accident Report (e-DAR), erstwhile Integrated Road Accident Database (iRAD), which is a central repository for reporting, management, claim processing and analysis of road accidents data to enhance road safety in the Country. The application has been rolled out in all States and UTs for live data entry. The application will be used for monitoring and analysis of road accidents data and effective decision making.

Work Environment

A positive work environment plays a pivotal role in influencing employee health, relationships at work, teamwork, and overall well-being. The Ministry recognizes this and has taken strategic initiatives to foster a harmonious and safe workplace.

General Section within the Ministry is tasked with overseeing the physical infrastructure and maintenance of the complex. The section's mandate is to ensure the preservation of physical infrastructure, encompassing security, parking, and the management of contract workers responsible for sanitation and cleanliness. The Section monitors and regulates cleanliness and sanitation in the Ministry like COVID related sanitization of premises, supply and maintenance of green potted plants in the building premises, creation of water and sanitation infrastructure and pest/termite control, disposal of old furniture, digitization of documents and weeding out of obsolete files to clear out space for productive use, maintenance of waste management equipment and infrastructure and Swachh Awareness activities for the staff including cleanliness drives, etc.

4.1.4. Methods Adopted for External & Internal Communication, Citizen Outreach, Stakeholder Communication, etc.

Since, MoRTH is involved multiple activities including development and maintenance of National Highways, Transport & Logistics polices, Road Safety activities etc., there is extensive need for outreach, coordination, and consultations. The Ministry interacts with other ministries at the central level and also departments/ sections dealing with related issues at the state level. At the central level, the Ministry closely works in tandem with the Ministry of Heavy Industries, Ministry of Home Affairs, Ministry of Health & Family Welfare, Ministry of Education, Niti Aayog etc.

Further, at the state level, the Ministry also interacts with state government departments looking after road development and transport in the states. For example, this includes State Public Works Departments (PWDs), State Regional Transport Office (RTOs), State Police Department etc.

Various communication activities that are adopted to communicate with both internal and external stakeholders, are described under the following heads:

Communication And Coordination

The communication and coordination function in the Ministry is divided into the following sub-components, that have defined structure and protocol:

- **Inter-Ministerial Coordination:** For inter-ministerial coordination, the Establishment division has allocated specific ministries to various Wings/ Divisions in the Ministry. In the matters involving finance, inter-ministerial communication is restricted to e-Office. Ministry facilitates consultation between concerned ministries and departments that are relevant for a set of activity. The inputs are also collected from the concerned states and industry stakeholder. This ensures a consultative and inclusive approach for decision-making and policy formation by taking inputs that are received from all the relevant stakeholders.
- **Intra-departmental Communication:** For intra-departmental communication, a formal channel of submission is used through which all formal communications, information flows and file movements take place in the Ministry. Internal administrative communication is initiated and coordinated by the O&M department under its allocated tasks through Office Memorandum (OM). Any other communication between the sections and the divisions related to subject matter queries and concurrences takes place directly through e-mails and files where the communication are direct replies or notes.
- **Inter-departmental Communication:** Sections dealing with attached or subordinate offices, autonomous bodies, directly communicate with them through assigned dealing hand (on case-to-case basis, it may be a single point of contact or a group of people). Each section is assigned a department, ministry, office of Gol, etc., hence communication takes place in coordinated manner.

In addition to above, the Ministry also adheres to various communication mechanisms to ensure citizen-centric approach. These include Citizen Charter, Right to Information and Grievance Redressal.

Citizen's Charter

Citizen's Charter ensures that the organization commits towards quality, standard timeframe of service delivery, transparency, grievance redressal mechanism and accountability.

The components of the Citizen's Charter include details of business, coordinated by the Ministry; expectations from the service recipients; details of services provided to each client group; details of the grievance redressal mechanism and how to access it.

The Citizen's Charter is typically updated on bi-annual basis by the O&M section of Ministry.

Right to Information

The Right to Information Act, 2005 mandates timely response to requests made by citizens for availing government information. RTI Portal Gateway has been created where citizens can search for details of the first Appellate Authorities, PIOs, etc. amongst others. It also provides access to the RTI related information, any disclosures that have been published on the web by public authorities under the Government of India and state governments.

The responses given by the RTI division in Ministry are subject to the nature of the query. The RTI Section first analyze the RTI requests and then it is shared with the relevant Wing/ Division/ Section for reply.

Grievance Redressal

Grievance Redressal is a term that primarily covers receiving and processing of complaints from citizens / consumers, but a wider definition includes actions taken on issue raised by citizens that help them avail more services effectively.

Within the Ministry, the respective sections have 30 days to resolve a grievance / respond back. The task of timely disposal of RTI and Public Grievances is allocated to a dealing hand (refers to the officer who acts as point of contact for the department, it can be officer at ASO or SO level), who would prepare and approve the response via the channel of submission. The CR section in Ministry does grievance disposal in 2 parts: (i) the internal review, and (ii) the official review. CR section is responsible speedy resolution of all grievances.

Currently, there is no formal process to identify, analyze or resolve the root cause of any grievance in the Ministry.

4.1.5. Knowledge Management

There is a need for a dedicated Knowledge Management System (KMS), that stores and retrieves knowledge to improve understanding, and collaboration, as well as ensures process alignment.

As per the CSMOP, the term Knowledge Management refers to the handling of a single file and the components of a file shall include:

- Note for the Successor: induction material from the predecessor to be able to understand the work allocation and should have supporting documents to maintain institutional memory.
- Standard Process Sheet: it provides checkpoints to process cases of repetitive nature.
- Standing Guard File: it is a repository of all decisions taken on a particular subject matter collated at a single point.
- Standing Note: it is a continuing note that explains matters like the history and development of a policy, procedure for amendment and formulation, etc. The note serves as a complete background material for review of the existing policy or procedure.
- Precedent Book: it is a register that maintains in a prescribed format important noting and decisions that have an affirmative or precedent value for ready reference.
- Reference Folder: it is a folder that is maintained by individual officers and contains basic details, rules, instructions, guidelines, etc. on a specific topic, as considered necessary by the officer, which is of immediate use for processing a case.

The e-Office of MoRTH has an integrated KMS, which can be accessed by the officers in the Ministry. This system acts as a repository for the information generated in the Ministry. The KMS automatically updates any documents uploaded in notification panel onto the centralized repository.

Presently, the e-Office KMS cloud operates below its full capacity, functioning primarily as a notification panel for displaying orders, memorandums, and notices. The existing underutilization stems from a limited understanding among officials and a gradual adoption of the digital system.

In addition to managing knowledge, Ministry requires a systematic process for knowledge transfer. Currently, within the Ministry, there is no formal mechanism for knowledge transfer, relying primarily on "learning by doing" or "learning from peers." New entrants receive informal orientation about their roles and responsibilities, with introductory training provided for the e-Office. Asset transfer occurs through the handing over of notes and files, whether they are in online or offline formats.

This lack of a formal "knowledge transfer" mechanism has impacted the seamless transition of responsibilities and information flow. It results in a lack of understanding of priority tasks, commonly adopted methods and processes, best practices, etc., across various work streams.

Capacity Requirement & Development

The induction of government officers (permanent posts) has two channels: Central Secretariat Staff (CSS) or officers recruited and deputed through Civil Services. However, for contractual employees

the recruitment is undertaken through GEMS portal through open bidding and through advertisement and interviewing young professionals and interns that takes place from time to time.

There is a formal procedure in Ministry to allocate additional charges to officials. And additional charges are allocated as “order-based” or “need-based”. MoRTH has a system for approving and posting additional charge, but no DoPT mandate or procedure has been set for the same.

The Ministry doesn't have a formal procedure to identify training needs of the officials. Generally, a training calendar is issued by IAHE, and officials nominate themselves for a training on a need basis, which is then processed by the Establishment or Administration section.

4.2. Business Process Evaluation

Table 6: Business Process Evaluation

KPI	Evaluation Criteria	Rating (Y/N)	Capacity Building Recommendation	
			Individual	Organizational
Process Management and responsibility	Are comprehensive management systems established to oversee the entire workflow?	N	<ul style="list-style-type: none"> No process management tool is currently available at individual level. Various portals are introduced to work on such as for grievance redressal etc. not for process management. The currently followed measures are as per the channel of work mentioned in the CSMP manual. All employees must be trained in the available management tools and briefed about adhering to process and organizational structures mentioned in their manuals. 	<ul style="list-style-type: none"> MoRTH may utilize the Establishment division to analyze skills, competency, work allocation and service delivery of the existing officials within the reporting structure and timeline of task disposal for promoting better efficiency of officers. There is a need to allocate defined roles to the Multi-Tasking Staff at the department. As per the consultations, the Department has “overqualified” MTS staff, who can be leveraged for “other technical responsibilities” apart from “mandated office work.” For ASO/SO and US level officers, “job rotation” across different verticals can help in building their “conceptual knowledge” and also help them better understand “relatedness across different divisions and verticals. Reduce instances of multiple reporting channels for operations within the Department While the existing system supports workflow management, there is a need to upgrade it to include clear accountability, consider other urgent and uncertain deliverables handled etc. Induction /Refresher module is suggested to include small e – modules on management tools.
	What types of management tools are utilized – online, offline, or a combination of both?	N		
	Do the project management tools integrate seamlessly with other systems and processes within the MDO?	N		
	Are the processes clearly outlined and well-defined?	N		
	Do these processes encompass all facets of the schemes or programs?	N		
	Is there a standard operating procedure (SoP), manual, guide, or FAQs for these processes?	Y		
	Are all relevant staff members adequately familiar with these processes?	N		
Documentation Process, Noting, Drafting, report writing	Are there any relevant process / trainings for documentation readily accessible to all relevant staff members?	N	<ul style="list-style-type: none"> Courses on documentation skills such as MS Office, documentation procedures for government officials etc. More trainings are suggested for report writing, Noting, drafting etc. for officers. Trainings can be accessed form portals like iGOT, and few trainings are conducted on physical model as well by ISTM. 	<ul style="list-style-type: none"> MoRTH should focus on introducing some project management tools for monitoring of work, streamlining processes, aligning proper resources etc. Enabling such tools into the process will enhance the management of tasks as well as quality of documentation as well.

KPI	Evaluation Criteria	Rating (Y/N)	Capacity Building Recommendation	
			Individual	Organizational
Data Management	Is performance data collected and systematically analyzed throughout the project/scheme period?	N	<ul style="list-style-type: none"> • Courses and training programs in impact analysis and evaluation methods are recommended for officers across all hierarchical levels. • Trainings can be accessed form portals like iGOT, and few trainings are conducted on physical model as well by ISTM. 	<ul style="list-style-type: none"> • MoRTH is currently developing a dashboard to regularly update project and scheme data. • Post its launch, comprehensive training sessions will be essential for all staff to efficiently utilize this tool.
	Does the organization take ownership of this analysis?	N		
	Is this data utilized to inform and support decision-making for both ongoing and future projects/schemes?	Y		
	Are the employees adequately trained in utilizing data analysis tools?	N		
	Are senior personnel well-equipped to utilize such analysis and evidence for decision-making purposes?	N		
Performance evaluation/assessment	Are there explicit performance metrics to gauge success, efficiency, and effectiveness of the process?	N	<ul style="list-style-type: none"> • Training programs covering Performance Enhancement, Workplace Efficiency, Data-Driven Governance, and Quality Enhancement are recommended for officers at every level. Moreover, specialized sessions on "Robust Leadership" and "Effective Team Management" are proposed for senior officers. 	<ul style="list-style-type: none"> • Ministry needs to strengthen this aspect of performance management and task monitoring. • Delays have been identified and process needs to be streamlined for effective internal management.
	Is there a specified schedule for concluding each stage of the process?	N		
	Are there any unnecessary repetitions or overlaps in time or labor within the process?	N		
	Is there a functional system in place to monitor the performance of the process?	N		
	Is the process regularly assessed to ascertain its effectiveness in achieving planned objectives?	N		
	Are employees familiar with the performance benchmarks for the process?	N		
	Do staff actively engage in the evaluation process and provide feedback?	N		

KPI	Evaluation Criteria	Rating (Y/N)	Capacity Building Recommendation	
			Individual	Organizational
Personnel Management and coordination	Are there established channels for resolving internal employee issues effectively?	Y	<ul style="list-style-type: none"> • Training programs focusing on leadership, communication skills, and government rules and procedures are recommended, particularly tailored for senior officers. • Trainings to prevent sexual harassment in the workplace are also suggested. 	<ul style="list-style-type: none"> • Encourage team building activities within the workplace. • Promote collaboration through brainstorming sessions, an attempt to prevent creation of 'silos' in the workplace and enhance efficiency. • For dispute resolution internally rules as per CSMOP are followed. • To conduct regular performance reviews for better officers to upskill them regularly and provide relevant trainings.
	Does the department create a conducive environment for effectively managing cases related to sexual harassment?	Y		
	Is there a formalized procedure in place for collecting employee feedback?	N		
	Do employees actively engage in regular capacity-building initiatives and training programs?	N		
Effective communication	Do effective channels of coordination/communication exist within the department across sections and divisions?	Y	<ul style="list-style-type: none"> • Trainings on effective communication, negotiation with stakeholders, managing international delegates has been identified for skilling of officers. 	<ul style="list-style-type: none"> • Ministry has adopted central government portals for updating of matters and provide official communications.
	Are there well-established channels of coordination/communication with other MDOs, either directly or indirectly?	Y		
	Does the department incorporate digital tools to facilitate communication?	Y		
	Are there established channels to handle references and communications from high public offices (such as PMO, Parliament, Cabinet Committees, etc.)?	Y		
Risk Mitigation	Are the identified process-related risks appropriately identified and managed?	N	<ul style="list-style-type: none"> • Risk management has been identified as one of the weak areas. • Refresher / induction training to be provided to upskill officers on the importance of risk and how to mitigate the same. • Various trainings are also conducted by ISTM and on Karma Yogi portal 	<ul style="list-style-type: none"> • At the Ministry level, there should be a proper SOP designed to follow as a process of necessary checks to consider any important decision.
	Does the SoP/manual/guide/FAQs encompass risk management?	N		
	Are employees adequately knowledgeable about risk management procedures?	N		

KPI	Evaluation Criteria	Rating (Y/N)	Capacity Building Recommendation	
			Individual	Organizational
Right to Information	Is there any dedicated portal in the Ministry to handle RTI related matters?	Y	<ul style="list-style-type: none"> Ministry needs to work on strengthening the RTI management. There should be a proper record management and authentication process to handle RTI matters. 	<ul style="list-style-type: none"> The Ministry / concerned section may undertake root cause analysis of RTIs received which may enable it to not only reduce RTIs, but also update or better its information dissemination practices. There should be a shift in focus from disposal of RTIs to analysis of RTIs received to understand the nature of information sought and the reason for the same. The RTI section could consider publicly disclosing the relevant RTI data on its website or specific portals/dashboards, thereby aiding citizens in better understanding the department's operations.
	Are the officers trained to handle matters related to RTI?	N		
	Is there proper record management of the RTI responses?	N		
	Are the post-analysis findings of the RTI responses accessible to the staff for the department's improved functioning?	N		
	Are the RTI responses authenticated?	N		
	Is there categorization and comprehensive scrutiny of responses based on section/divisions to identify root causes?	N		
Grievance Redressal and Public Relations	Is there any adherence to deadline for handling public grievances?	N	<ul style="list-style-type: none"> Various courses have been suggested to train officials on grievance management. Several Portals are also processed to manage public related. MoRTH being the head body receives the cases at a higher rate hence, there is a crucial requirement to fasten the process of grievance redressal for citizen convenience. Various courses are provided on training platforms such as Karma yogi portal, ISTM etc. 	<ul style="list-style-type: none"> The Department may inculcate the practice to identify core grievance prone areas and streamline their system to eliminate root cause of grievances. Each division/section should categorize the received grievances to enhance the refinement of various processes or administrative tasks within the Department.
	Are there proper grievance disposal mechanisms?	Y		
	Is there systematic monitoring and tracking of disposal rates and cases of these grievances across sections/divisions?	Y		
	Is there an investigation into the root causes of incoming grievances by the relevant authority in the MDO?	N		
	Does the institution promote the formal resolution of grievances and complaints received via social media platforms?	Y		

KPI	Evaluation Criteria	Rating (Y/N)	Capacity Building Recommendation	
			Individual	Organizational
Public Focus (Citizen centricity)/ Service Provision	Is there regular updating of the Ministry's vision and functions declaration communicated to the citizenry or the public?	N	<ul style="list-style-type: none"> A refresher course/ induction material to be designed for new joiners and officers in position to increase awareness of Citizen charter, along with Vision, mission, and future goals of the citizen charter. 	<ul style="list-style-type: none"> Ministry should update the Citizen charter to increase awareness. Regular and periodic monitoring of processes, along with reviews of protocols and final outcomes, unveil existing system gaps and identify potential focus areas for improvement.
	Is there an accessible Grievance Redressal mechanism provided for the public?	Y		
	Is the Department ensuring that clients/public are informed about the timeline for service delivery?	Y		
	Is the Ministry effectively organizing and presenting its array of services to both its clients and the public?	Y		
Information Management & Knowledge transfers	Are adequate tools for Knowledge Management (KM) accessible to the staff throughout the MDO?	Y	<ul style="list-style-type: none"> It is essential to consider incorporating a brief e-module /physical training on Knowledge Management during the induction process. This module can also be provided to all officers, serving as a refresher / induction training, 	<ul style="list-style-type: none"> Regular updates and refinement of the Knowledge Management System (KMS) are necessary. It has identified that MoRTH requires a smooth KMS functioning and hence trainings are suggested to enhance the same. The current KMS within MoRTH aligns with the Central Secretariat Manual of Office Procedure. The transition to include new modes of information management still remains unfulfilled. Presently, the existing e-office KMS cloud is underutilized, primarily functioning as a notification panel.
	Are all concerned individuals adequately educated in KM procedures and practices?	N		
	Is the KMS compilation and updates regularly reviewed by concerned authorities?	N		
	Does the MDO undertake formal and systematic KM transfer procedures?	N		
	Does the project management system encompass the involvement of all stakeholders?	Y	<ul style="list-style-type: none"> Courses have been recommended for enhancing stakeholder engagement based on the responsibilities and roles of different officers. 	<ul style="list-style-type: none"> Data/ record management of the stakeholders needs to be improved for both internal and external stakeholders. Effective communication needs to be practiced for better governance of matters. Trainings on effective communication is must to foster clear knowledge

KPI	Evaluation Criteria	Rating (Y/N)	Capacity Building Recommendation	
			Individual	Organizational
Stakeholder Governance	Does the internal Statement of procedures and guidelines cover the stakeholder management, relationship governance with other authorities?	N		transfers and building network and trust.
	Are stakeholders involved and consulted throughout the process as per requirement?	Y		<ul style="list-style-type: none"> • Timely consultations need to involve in the processes for identification of the key focus areas. Trainings can be provided to cover the gaps and implementation plan can be created. • Involvement of stakeholders for important matters of discussions to be encouraged to work on latest viewpoints.

5. Capacity Building Plan

5.1. Approach & methodology

The main objective of the study is to improve the overall efficiency of the employees of Ministry of Road Transport & Highways. Before creating Annual Capacity Building Plan, various assessments and surveys were conducted to streamline the approach and methodology for creating capacity building plan.

The report covers analysis under various lenses such as alignment with national priorities, citizen centricity and overall organizational goals. Focus of the report is to enhance the capacity at Institutional, Organizational, and Individual level. The Final plan comprises of the relevant set of trainings proposed for functional, behavioral and domain specific skillsets based on the gap assessments.

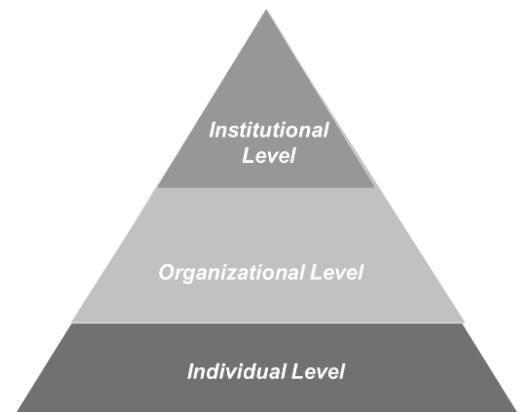

The strategy used for the exercise is depicted in the figure below. As shown, an as-is analysis based on secondary research and official documentation available on the department's organizational structure was conducted. To understand the roles & responsibilities more Later, a primary survey was floated among all the designations from Assistant Section Officer (ASO) to Additional Secretary (AS) Level to record their inputs for the level of competencies and assess the requirements of the skills. Challenges and interventions required were recorded based on the inputs received during Stakeholder consultations. The figure below shows the schematic representation of the Approach and Methodology with the involved steps –

Figure 38: Overall Approach of Exercise

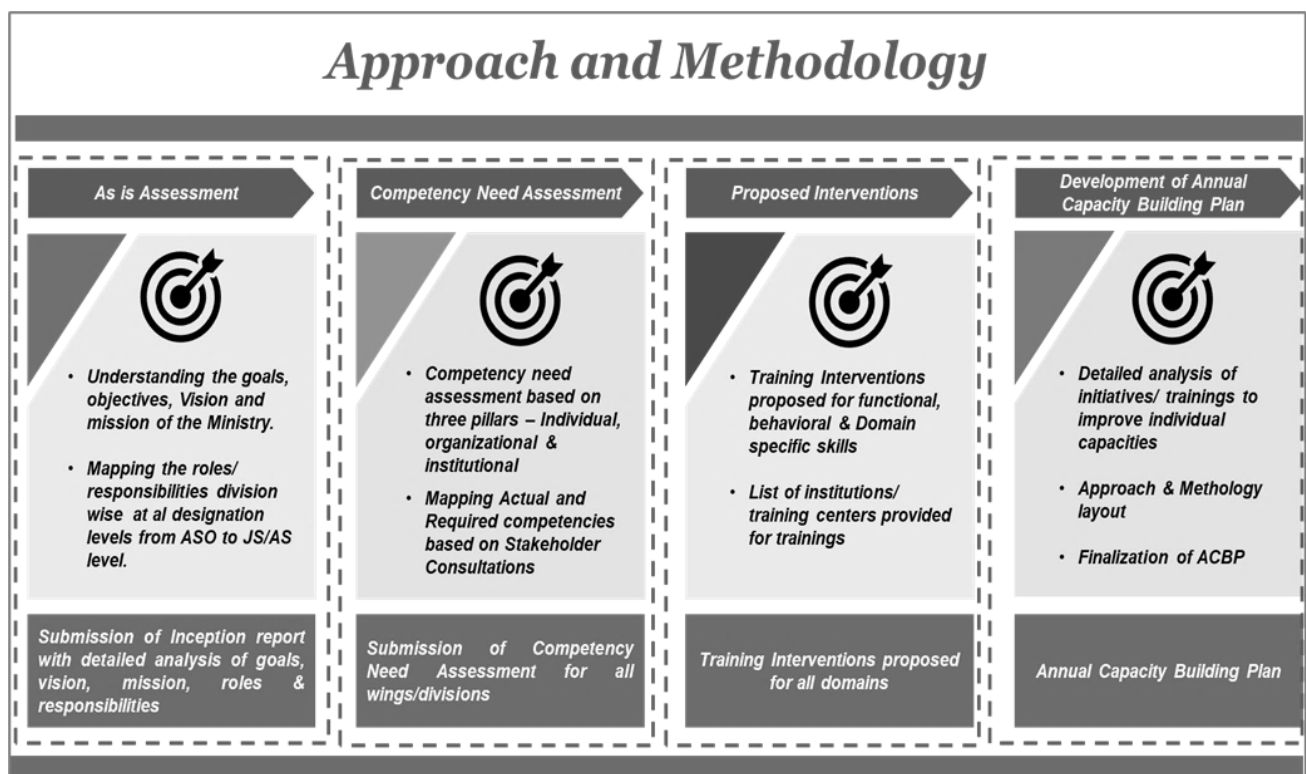

As a part of as – is assessment the goals, objectives and vision, mission is mapped for the MDO. From the responses covered in the survey while consulting the stakeholders, the pain points, challenges, and the areas that required interventions could be identified.

During the meeting with Capacity Building Unit (CBU) of MoRTH held on 18th May 2023 in Transport Bhawan, it was decided that Functional and Behavioural competencies will be Division/ Section agnostic and Domain competencies will be specific to particular Division/ Section.

The figure below shows the consultation process that was followed to record inputs from the stakeholders across various wings. This helped in reporting, identifying the challenges, proposing a proper road map for the bringing in improved interventions for the Ministry of Road Transport and Highways. The consultation process with interactions with senior officials, continued with mid senior and junior level officers. Officers were requested to fill a primary survey for recording the inputs.

Figure 39: Consultation process adopted

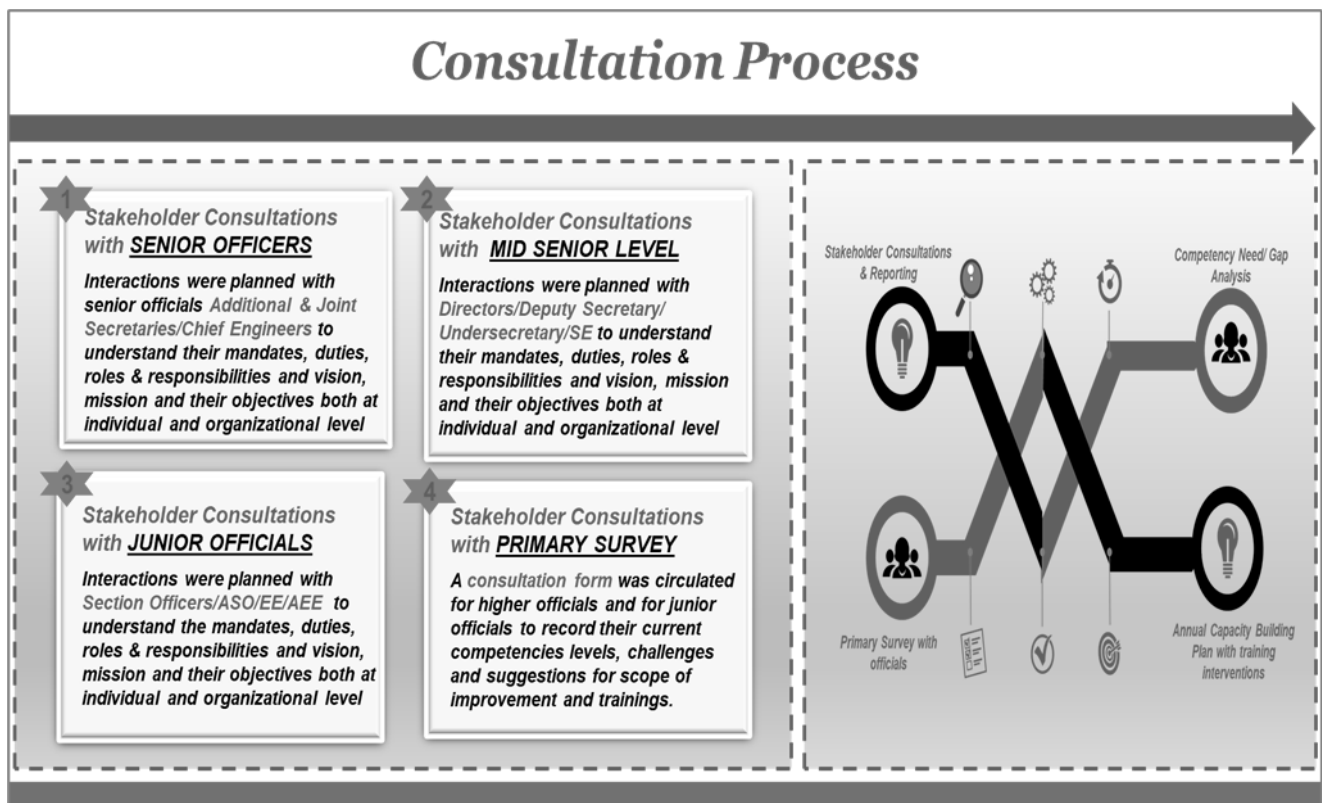

Specific set of trainings are proposed from various institutions covering all functional, behavioral and domain specific set of trainings were prepared. Ideas to consider MoUs with world class institutions for the training and development of senior officials is also proposed as a part of capacity building initiative.

5.2. Competencies Identified and Capacity Building Interventions Suggested: Division Agnostic

Functional and behavioral skills required for the officers at the individual level across various Wings/ Divisions/ Sections of MoRTH are overlapping in nature. This section provides the consolidated list of functional and behavioral competencies required to complement the domain knowledge and technical know-how (division specific domain competencies are discussed in the next section).

Hence, this section carries out competency assessment across two categories:

- **Behavioral competencies** include competencies related to behavior and soft skills such as negotiation skills, self-motivation, interpersonal skills, etc. One of the most important competencies under this segment is the citizen centricity/stakeholder focus capability.
- **Functional competencies** include competencies related to the functional aspects of the division such as MS office skills, financial procedures, grievance redressal, etc. and most importantly, technological know-how.

These competencies include combination of theoretical and practical knowledge, cognitive skills, adoption of technology and automation, values, and behavior to improve performance. These competencies and suggested trainings have been identified basis the three-lenses: National priorities, citizen centricity, and Emerging technologies. The table below illustrates the behavioral and functional competency requirements across all Wings of the Ministry.

Table 7: Division-agnostic competency requirements

#	Competency	Areas of Work Responsibility	Competency Requirements Identified	Lenses addressed
1)	Behavioral Competency	Coordination with stakeholders/ private players	<ul style="list-style-type: none"> • Verbal communication; Liaisoning and Negotiation skills • Multitasking and time management • Administrative and managerial skills • Stakeholder and people management 	<ul style="list-style-type: none"> • National priorities • Citizen centricity
		Coordination with other Ministries and Parliamentary matters	<ul style="list-style-type: none"> • Gender sensitization and anti-sexual harassment • Organizational skills (such as planning, delegation, knowledge of key responsibility areas, goal setting, team building etc.) 	<ul style="list-style-type: none"> • National priorities • Citizen centricity
		Negotiate with foreign governments and agencies	<ul style="list-style-type: none"> • Health and well-being, and stress management 	<ul style="list-style-type: none"> • National priorities
		Easy grievance redressal mechanisms	<ul style="list-style-type: none"> • 8Adaptation to new skills and methodologies 	<ul style="list-style-type: none"> • National priorities • Citizen centricity
		Improvement in the best practices		<ul style="list-style-type: none"> • National priorities • Citizen centricity • Emerging technologies
		Team building, leadership and effective governance		<ul style="list-style-type: none"> • National priorities • Citizen centricity • Emerging technologies
		Citizen centric work	<ul style="list-style-type: none"> • Gender sensitization and anti-sexual harassment 	<ul style="list-style-type: none"> • Citizen centricity
2)	Functional Competency	Skills for Data handling	<ul style="list-style-type: none"> • MS Office (Word, PowerPoint, Excel) 	<ul style="list-style-type: none"> • National priorities • Emerging technologies
		Procurement and Contract management	<ul style="list-style-type: none"> • Project Appraisal, project procedure, Project estimation, Project sanction process as per Ministry and Government of India rules 	<ul style="list-style-type: none"> • National priorities • Emerging technologies

#	Competency	Areas of Work Responsibility	Competency Requirements Identified	Lenses addressed
		Administration related matters	<ul style="list-style-type: none"> Central Portals (e-office, NIC Portal, Grievance Portal, VIP Portal, Bhoomirashi Portal and any other relevant portal) GRM (Grievance Redressal Mechanism), CPGRAMs and INGRAMs Portals 	<ul style="list-style-type: none"> National priorities Emerging technologies Citizen centric
		Drafting, noting and MS office skills	<ul style="list-style-type: none"> Government documentation (noting, drafting, cabinet notes, parliamentary answers, reports, Memorandum of Understanding etc.), reporting for parliamentary procedures, questions, and RTI queries 	<ul style="list-style-type: none"> National priorities Emerging technologies
		Financial skills	<ul style="list-style-type: none"> Financial procedures/ GFR/ Bill clearances/ PFMS 	<ul style="list-style-type: none"> National priorities Emerging technologies
		Legal awareness	<ul style="list-style-type: none"> Judicial Pronouncement and Restrictions, Audit Paras and Court Cases 	<ul style="list-style-type: none"> National priorities Citizen centricity Emerging technologies

From the above tables, it can be inferred that both functional and behavioral skills are essential for the upskilling of the individuals within the MDO. It will enhance the internal coordination, data management and ease the administrative concerns as well.

Based on the identified competencies, a detailed training calendar has been prepared for the functional and behavioral skills.

Table 8: Division-agnostic competency requirements

Training Program	Modules Covered	Mode	Target Group	Duration	Category	Knowledge Partner
Excel Advanced	<ul style="list-style-type: none"> The course provides advanced topics on Excel 	Online	Up to Director Level	3h 49 mins	Functional	iGOT
Advance PowerPoint	<ul style="list-style-type: none"> The course provides advance topics on power point 	Online	Up to Director Level	2 hrs 28 mins	Functional	iGOT
MS Word	<ul style="list-style-type: none"> The course provides the basic to intermediate skills for MS Word 	Offline	Up to Director Level	3 days	Functional	iGOT
Noting & drafting	<ul style="list-style-type: none"> The course provides noting and drafting in a secretariat set up. 	Online	Up to Director Level	2 hrs	Functional	iGOT
Preparation of Cabinet Notes	<ul style="list-style-type: none"> The course provides content on preparation of cabinet notes in a secretarial set up 	Online	Up to Director Level	5 hrs 10 mins	Functional	iGOT
GFR - Rule book	<ul style="list-style-type: none"> The document provides the essential GFR rules 	Online	Up to Director	Self Paced	Functional	-

Training Program	Modules Covered	Mode	Target Group	Duration	Category	Knowledge Partner
			Level			
Financial Procedures – Cash & Accounts	<ul style="list-style-type: none"> The course provides topics on financial procedures, cash management and accounts for new joiners and officers in position. 	Online	Up to Director Level	Self Paced	Functional	ISTM
Public Financial Management System (PFMS) Training – <u>Every Month</u>	<ul style="list-style-type: none"> This training is conducted by Ministry of Finance for awareness on PFMS related topics 	Online	(Nomination basis)	Self Paced	Functional	Ministry of Finance
Foundational course on Grievance redressal Mechanism by ADB	<ul style="list-style-type: none"> The course provides basic guidelines on grievance redressal 	Online	US, DS, Director, SE, CE	Self Paced	Functional	ADB
Public Grievance Handling & CPGRAM7.0	<ul style="list-style-type: none"> The module provides the awareness on public grievance handling and CPGRAM 7.0 Portal 	Online	All Officials	1 hr	Functional	iGOT
Public Procurement Framework for government processes	<ul style="list-style-type: none"> The course provides details on public procurement process and frameworks 	Online	Up to Director Level	Self Paced	Functional	iGOT
Digital India & e-Governance	<ul style="list-style-type: none"> Digital India is an Umbrella Program covering many departments and pulls together many existing schemes to be restructured and re-focused to be implemented in a synchronized manner with a distinctive focus on e-Governance. 	Offline	Directors and Above	3 Days	Functional	National Institute for Smart Government (NISG)
Cyber Security and Strategy	<ul style="list-style-type: none"> Data Protection & Recovery Network Security, Dark web and VPN New emerging security threats and Global Cyber Security Index Cyber Diplomacy and Warfare 	Online	All Officials	1 Day	Functional	iGoT
Administrative Law	<ul style="list-style-type: none"> This provides knowledge on administrative laws and basic knowledge on code of conducts 	Online	All Officials	1 hr 3 mins	Functional	iGOT
Effective Communication	<ul style="list-style-type: none"> The course emphasizes on the need for professional communication 	Online	Up to Director Level	5 hrs 34 mins	Behavioral	iGOT
Workshop on Communication Skills	<ul style="list-style-type: none"> The workshop provides the basic communication skills 	Online	US, DS, Director, SE, CE	1 day	Behavioral	ISTM
Online Workshop for Liaison Officers	<ul style="list-style-type: none"> The workshop provides skills on liaising of officers 	Online	Up to Director Level	2 days	Behavioral	ISTM

Training Program	Modules Covered	Mode	Target Group	Duration	Category	Knowledge Partner
Time Management	<ul style="list-style-type: none"> The module covers effective ways to utilize time and complete work within a given timeline 	Online	DS & above	1 hr 15 mins	Behavioral	iGOT
Stakeholder in Governance	<ul style="list-style-type: none"> The course the management skills for stakeholders and covers topics on governance 	Online	Up to Director Level	1 hr 43 mins	Behavioral	iGOT
Prevention, Prohibition & Redressal of Sexual Harassment of Women at Workplace	<ul style="list-style-type: none"> The course provides basic awareness of sexual harassment and its prevention 	Online	All Officials	1 day	Behavioral	ISTM
Team Building	<ul style="list-style-type: none"> The training module provides the importance of team building with effective leadership. 	Online	Up to Director Level	1 hr 25 mins	Behavioral	iGOT
Public Administration	<ul style="list-style-type: none"> The course provides the basics of public administration 	Online	Up to Director Level	1 hr 15 mins	Behavioral	iGOT
Yoga for excellence	<ul style="list-style-type: none"> The course provides simple stretches to boost immunity 	Online	Up to Director Level	1 hr	Behavioral	iGOT
Stress Management	<ul style="list-style-type: none"> The course provides the importance of stress management and its effects 	Online	All Officials	1 hr 15 mins	Behavioral	iGOT
DoPT Stress Management Training Program for Officers	<ul style="list-style-type: none"> The training is conducted by DoPT for officers in position to tackle the workplace stress and manage health. 	Offline	Director & above	NA	Behavioral	DoPT
Interpersonal skills	<ul style="list-style-type: none"> The course provides the overall development values for growth of interpersonal skills 	Online	Up to Director Level	1 hr 37 mins	Behavioral	iGOT
Digital Literacy	<ul style="list-style-type: none"> The course provides the aspects of digital literacy 	Online	All Officials	2 hrs 36 mins	Behavioral	iGOT
Introduction to Leveraging AI and ChatGPT	<ul style="list-style-type: none"> The course provides a comprehensive understanding of AI and how it can be used in various domains 	Online	All Officials	24 mins	Behavioral	iGOT
CSS Level B: Assistant Section Officer	<ul style="list-style-type: none"> Induction course for Assistant Section Officer 	Online	ASO	46 hrs	Behavioral & Functional	iGOT
CSS Level C: Section Office	<ul style="list-style-type: none"> Induction course for Section Officer 	Online	SO	36 hrs	Behavioral & Functional	iGOT
CSS Level E: Under Secretary	<ul style="list-style-type: none"> Induction course for Under Secretary 	Online	US	42 hrs	Behavioral & Functional	iGOT
CSS Level F: Deputy Secretary	<ul style="list-style-type: none"> Induction course for Deputy Secretary 	Online	ASOs	35 hrs	Behavioral & Functional	iGOT

5.3. Competencies Identified and Capacity Building Interventions Suggested: Division Specific

This chapter contains the domain specific competencies for each Wing/ Division/Section. The detailed list of competencies and training/courses is highlighted for each division as follows:

5.3.1. Road Wing

5.3.1.1. Regional Zones

Some of the key focus areas of the Regional Zones –

- Road development including engineering, cost estimation, construction, and monitoring.
- Maintenance of National Highways including planning, engineering, implementation, and monitoring
- Quality control and assurance
- Road safety engineering and audit
- Relevant acts, regulations and guidelines published by the government
- Project Management, controlling and reporting including various project management tools and techniques.
- Contract management and administration
- Arbitration and dispute resolution
- Latest practices and technologies related to design, construction, maintenance & materials used in highways.
- Procurement of works, services, and consultancy
- Bridge and Tunnel engineering

S. No.	Competency Assessment	Skills/Competency Related Intervention Suggested
1	Highway development including engineering, cost estimation, construction, and monitoring	<ul style="list-style-type: none"> • Technical trainings on engineering, construction and monitoring of old/new road projects. • For more exposure to on field learnings
2	Maintenance of National Highways including planning, engineering, implementation, and monitoring	<ul style="list-style-type: none"> • Technical trainings for planning, engineering, and implementation activities • Study of National highways, various schemes, planning modules etc.
3	Quality control and assurance	<ul style="list-style-type: none"> • Modules for ensuring quality and assurance practices for all ongoing / upcoming road projects to avoid any casualties.
4	Road safety engineering and audit	<ul style="list-style-type: none"> • Trainings based on road safety, road safety audit, and engineering for all appointed officers
5	Relevant acts, regulations and guidelines published by the government	<ul style="list-style-type: none"> • Training materials for knowledge of essential guidelines set by government to understand basic acts, regulations etc.
6	Project Management, controlling and reporting including various project management tools and techniques.	<ul style="list-style-type: none"> • Courses on project management • Report writing • Technical tools and skills for on job practices
7	Contract management and administration	<ul style="list-style-type: none"> • Courses on contract management from IAHE/ ISTM • Trainings on administrative norms and functions • Special trainings on Karma yogi portal
8	Arbitration and dispute resolution	<ul style="list-style-type: none"> • Courses on Arbitration • Dispute resolution as per government guidelines
9	Latest practices and technologies related to design, construction, maintenance & materials used in highways	<ul style="list-style-type: none"> • Study of latest technologies • New interventions in the road development

S. No.	Competency Assessment	Skills/Competency Related Intervention Suggested
		<ul style="list-style-type: none"> field Best practices from neighboring countries Successful models of road projects
10	Procurement of works, services, and consultancy	<ul style="list-style-type: none"> Courses on procurement
11	Bridge and Tunnel engineering	<ul style="list-style-type: none"> Tools and technologies for bridge and tunnel construction

Thus, for the Regional Zones few suggested domain trainings and exposure visits are mentioned below.

Training Program	Modules Covered	Mode	Target Group	Duration	Knowledge Partner
Preparation of DPR for Highways Project	<ul style="list-style-type: none"> The course covers the step wise preparation of the DPR report of a project 	Offline	Up to SE Level	6 days	IAHE
Design, construction, Maintenance & Operations of Expressway	<ul style="list-style-type: none"> The training covers modules on design, construction and operations of National Highways and Expressway 	Offline	Up to SE Level	5 days	IAHE
Construction of quality controls	<ul style="list-style-type: none"> Training modules covers the necessary standards required for safe construction practices. Quality controls are essential for any construction site to avoid any casualties 	Offline	Up to SE Level	5 days	IAHE
Quality Control/ Assistant Quality Control Engineers of Contractors/Consultants on Materials Testing Processes	<ul style="list-style-type: none"> Training modules covers the necessary quality control learnings for on site engineers 	Offline	SE and Above	6 days	IAHE
Certificate course on Road Safety Auditor	<ul style="list-style-type: none"> This certificate courses covers all aspects of road safety audit 	Offline	Up to SE level	15 days	IAHE
Related Acts/Rules - MoRTH Website	<ul style="list-style-type: none"> The document covers all relevant acts, rules available at MoRTH website. Officers should be aware of the relevant acts/ laws of the domain they work in 	Online	All Officials	Self-paced	-
Project Management	<p>The following modules covers the topics -</p> <ul style="list-style-type: none"> Identify steps in project management, Augment where focus to be given for smart project management, Assess the key issues in investment by taking up analytical exercises, Know how social value is created through investment, and Apply Randomized Controlled Trial (RCT) in project evaluation. 	Online	Up to EE level	1 hr 15 mins	iGOT
Project Management	<ul style="list-style-type: none"> The project management course covers stages involved in projects, with modules covering each stage with execution knowledge 	Offline	SE & above	4 Days	IAHE
Contract Management, Dispute Resolution and Arbitration in Highway Projects	<ul style="list-style-type: none"> The training covers modules on contract management, and dispute resolution as per rules set by the Government 	Offline	All Officials	5 days	IAHE
Good construction practices	<ul style="list-style-type: none"> The training covers modules on good practices adopted across the world 	Offline	All Officials	5 days	IAHE
New Technology Vision	<ul style="list-style-type: none"> The course covers the advancements in 	Online	All	1 hr.	iGOT

2022	the new technologies in the road sector		Officials		
Procurement of services, works and contracts	<ul style="list-style-type: none"> The module consists of PMSCY Guidelines for Empanelment and Engagement of Consultants for Preparation of DPR, TOR for Preparing DPR and Consultancy Agreement. and PIU Oversight and Interaction 	Online	Up to SE level	20 hours	iGOT
DPR for bridges	<ul style="list-style-type: none"> The training covers making of detailed project report 	Offline	Up to CE level	6 Days	IAHE
Online Training Program on Tunnels & Tunnelling	<ul style="list-style-type: none"> This online training program covers topics on tunnelling which includes topics on engineering, construction, and maintenance 	Online	Up to CE level	25 days	AF Academy

Exposure Visits:

Some trainings for foreign exposure are listed below for senior officials of the Regional Zones -

Training	Location	Provider/ Facilitator	Proposed Duration	Proposed Attendees
Maintenance Strategy Development and Cost-Effective Implementation (BMC)	Dubai	BMC Training	1 Week	SE & Above
Strategy for developing work zone traffic analysis.	USA	Federal Highway Administration	3 Days	CE & Above
Temporary Traffic Management (Certificate) 2 Slots	SLOT 1 - UTS Training 411 Long Acre Nechells Birmingham SLOT 2 - Venue TBC Birmingham	Temporary traffic management engineering Design Temporary signing, and other related highway engineering topics for high speed and rural and urban roads	1-day trainings	SE & Above

5.3.1.2. Planning Section

Some of the key focus areas of the Planning Section -

- Design & alignment of highways
- Administrative grant allocation
- Technical training of officers

S. No.	Competency Assessment	Skills/Competency Related Intervention Suggested
1	Highway development including engineering, cost estimation, construction, and monitoring	<ul style="list-style-type: none"> • Technical trainings on engineering, construction and monitoring of old/new road projects. • For more exposure to on field learnings
2	Maintenance of National Highways including planning, engineering, implementation, and monitoring	<ul style="list-style-type: none"> • Technical trainings for planning, engineering, and implementation activities • Study of National highways, various schemes, planning modules etc.
3	Quality control and assurance	<ul style="list-style-type: none"> • Modules for ensuring quality and assurance practices for all ongoing / upcoming road

S. No.	Competency Assessment	Skills/Competency Related Intervention Suggested
		projects to avoid any casualties.
4	Road safety engineering and audit	<ul style="list-style-type: none"> • Trainings based on road safety, road safety audit, and engineering for all appointed officers
5	Relevant acts, regulations and guidelines published by the government	<ul style="list-style-type: none"> • Training materials for knowledge of essential guidelines set by government to understand basic acts, regulations etc.
7	Contract management and administration	<ul style="list-style-type: none"> • Courses on contract management from IAHE/ ISTM • Trainings on administrative norms and functions • Special trainings on Karma yogi portal
8	Arbitration and dispute resolution	<ul style="list-style-type: none"> • Courses on Arbitration • Dispute resolution as per government guidelines
9	Latest practices and technologies related to design, construction, maintenance & materials used in highways	<ul style="list-style-type: none"> • Study of latest technologies • New interventions in the road development field • Best practices from neighboring countries • Successful models of road projects
10	Project Appraisal and Feasibility Analysis	<ul style="list-style-type: none"> • Training for conducting road project appraisals and feasibility analysis
11	Data analysis and processing	<ul style="list-style-type: none"> • Training to analyse large amount of data for insights and decision making

Thus, for the Planning Section few suggested domain trainings are mentioned below.

Training Program	Modules Covered	Mode	Target Group	Duration	Knowledge Partner
Preparation of DPR for Highways Project	<ul style="list-style-type: none"> • The course covers the step wise preparation of the DPR report of a project 	Offline	Up to SE Level	6 days	IAHE
Design, construction, Maintenance & Operations of Expressway	<ul style="list-style-type: none"> • The training covers modules on design, construction and operations of National Highways and Expressway 	Offline	Up to SE Level	5 days	IAHE
Construction of quality controls	<ul style="list-style-type: none"> • Training modules covers the necessary standards required for safe construction practices. Quality controls are essential for any construction site to avoid any casualties 	Offline	Up to SE Level	5 days	IAHE
Quality Control/ Assistant Quality Control Engineers of Contractors/Consultants on Materials Testing Processes	<ul style="list-style-type: none"> • Training modules covers the necessary quality control learnings for on site engineers 	Offline	SE and Above	6 days	IAHE
Certificate course on Road Safety Auditor	<ul style="list-style-type: none"> • This certificate courses covers all aspects of road safety audit 	Offline	Up to SE level	15 days	IAHE
Related Acts/Rules - MoRTH Website	<ul style="list-style-type: none"> • The document covers all relevant acts, rules available at MoRTH website. Officers should be aware of the relevant acts/ laws of the domain they work in 	Online	All Officials	Self-paced	-
Contract Management, Dispute Resolution and Arbitration in Highway Projects	<ul style="list-style-type: none"> • The training covers modules on contract management, and dispute resolution as per rules set by the Government 	Offline	All Officials	5 days	IAHE

Good construction practices	<ul style="list-style-type: none"> The training covers modules on good practices adopted across the world 	Offline	All Officials	5 days	IAHE
New Technology Vision 2022	<ul style="list-style-type: none"> The course covers the advancements in the new technologies in the road sector 	Online	All Officials	1 hr.	iGOT
Data Analytics using MS-Excel	<ul style="list-style-type: none"> Data collection, compiling, circulating time series data and analysis 	Online	Up to SE level	4 hours 30 mins	iGOT

5.3.1.3. S&R Section

Some of the key focus areas of the S&R Section –

- Research
- Planning
- Coordination and Cooperation
- Development of National Highways

S. No.	Competency Assessment	Skills/Competency Related Intervention Suggested
1	Highway development including engineering, cost estimation, construction, and monitoring	<ul style="list-style-type: none"> Technical trainings on engineering, construction and monitoring of old/new road projects. For more exposure to on field learnings
2	Maintenance of National Highways including planning, engineering, implementation, and monitoring	<ul style="list-style-type: none"> Technical trainings for planning, engineering, and implementation activities Study of National highways, various schemes, planning modules etc.
3	Road safety engineering and audit	<ul style="list-style-type: none"> Trainings based on road safety, road safety audit, and engineering for all appointed officers
4	Relevant acts, regulations and guidelines published by the government	<ul style="list-style-type: none"> Training materials for knowledge of essential guidelines set by government to understand basic acts, regulations etc.
5	Contract management and administration	<ul style="list-style-type: none"> Courses on contract management from IAHE/ ISTM Trainings on administrative norms and functions Special trainings on Karma yogi portal
6	Data analysis and processing	<ul style="list-style-type: none"> Training to analyse large amount of data for insights and decision making

Thus, for the S&R Section few suggested domain trainings and exposure visits are mentioned below.

Training Program	Modules Covered	Mode	Target Group	Duration	Knowledge Partner
Preparation of DPR for Highways Project	<ul style="list-style-type: none"> The course covers the step wise preparation of the DPR report of a project 	Offline	Up to SE Level	6 days	IAHE
Design, construction, Maintenance & Operations of Expressway	<ul style="list-style-type: none"> The training covers modules on design, construction and operations of National Highways and Expressway 	Offline	Up to SE Level	5 days	IAHE
Certificate course on Road Safety Auditor	This certificate courses covers all aspects of road safety audit	Offline	Up to SE level	15 days	IAHE
Related Acts/Rules	<ul style="list-style-type: none"> The document covers all relevant acts, 	Online	All Officials	Self-	-

- MoRTH Website	rules available at MoRTH website. Officers should be aware of the relevant acts/ laws of the domain they work in			paced	
Contract Management, Dispute Resolution and Arbitration in Highway Projects	<ul style="list-style-type: none"> The training covers modules on contract management, and dispute resolution as per rules set by the Government 	Offline	All Officials	5 days	IAHE
Good construction practices	<ul style="list-style-type: none"> The training covers modules on good practices adopted across the world 	Offline	All Officials	5 days	IAHE
New Technology Vision 2022	<ul style="list-style-type: none"> The course covers the advancements in the new technologies in the road sector 	Online	All Officials	1 hr.	iGOT
Data Analytics using MS-Excel	<ul style="list-style-type: none"> Data collection, compiling, circulating time series data and analysis 	Online	Up to SE level	4 hours 30 mins	iGOT

Exposure Visits:

Some trainings for foreign exposure are listed below for senior officials of the S&R Section -

Training	Location	Provider/ Facilitator	Proposed Duration	Proposed Attendees
Strategy for developing work zone traffic analysis.	USA	Federal Highway Administration	3 Days	CE & Above

5.3.1.4. Monitoring Section

Some of the key focus areas of the Monitoring Section -

- Monitoring of projects
- Report on Award & Construction process
- Intervention areas
- Bottleneck issues assessments
- Reviewing of projects
- Cost reduction
- Expedite growth of NH and SH

S. No.	Competency Assessment	Skills/Competency Related Intervention Suggested
1	Highway development including engineering, cost estimation, construction, and monitoring	<ul style="list-style-type: none"> Technical trainings on engineering, construction and monitoring of old/new road projects. For more exposure to on field learnings
2	Maintenance of National Highways including planning, engineering, implementation, and monitoring	<ul style="list-style-type: none"> Technical trainings for planning, engineering, and implementation activities Study of National highways, various schemes, planning modules etc.
3	Data analysis and processing	<ul style="list-style-type: none"> Training to analyse large amount of data for insights and decision making
4	Road safety engineering and audit	<ul style="list-style-type: none"> Trainings based on road safety, road safety audit, and engineering for all appointed officers
5	Relevant acts, regulations and guidelines published by the government	<ul style="list-style-type: none"> Training materials for knowledge of essential guidelines set by government to understand

S. No.	Competency Assessment	Skills/Competency Related Intervention Suggested
		basic acts, regulations etc.
6	Project Management, controlling and reporting including various project management tools and techniques.	<ul style="list-style-type: none"> • Courses on project management • Report writing • Technical tools and skills for on job practices
7	Contract management and administration	<ul style="list-style-type: none"> • Courses on contract management from IAHE/ ISTM • Trainings on administrative norms and functions • Special trainings on Karma yogi portal
8	Latest practices and technologies related to design, construction, maintenance & materials used in highways	<ul style="list-style-type: none"> • Study of latest technologies • New interventions in the road development field • Best practices from neighboring countries • Successful models of road projects
9	Procurement of works, services, and consultancy	<ul style="list-style-type: none"> • Courses on procurement

Thus, for the Monitoring Section few suggested domain trainings are mentioned below.

Training Program	Modules Covered	Mode	Target Group	Duration	Knowledge Partner
Preparation of DPR for Highways Project	<ul style="list-style-type: none"> • The course covers the step wise preparation of the DPR report of a project 	Offline	Up to SE Level	6 days	IAHE
Design, construction, Maintenance & Operations of Expressway	<ul style="list-style-type: none"> • The training covers modules on design, construction and operations of National Highways and Expressway 	Offline	Up to SE Level	5 days	IAHE
Certificate course on Road Safety Auditor	This certificate courses covers all aspects of road safety audit	Offline	Up to SE level	15 days	IAHE
Related Acts/Rules - MoRTH Website	<ul style="list-style-type: none"> • The document covers all relevant acts, rules available at MoRTH website. Officers should be aware of the relevant acts/ laws of the domain they work in 	Online	All Officials	Self-paced	-
Contract Management, Dispute Resolution and Arbitration in Highway Projects	<ul style="list-style-type: none"> • The training covers modules on contract management, and dispute resolution as per rules set by the Government 	Offline	All Officials	5 days	IAHE
Good construction practices	<ul style="list-style-type: none"> • The training covers modules on good practices adopted across the world 	Offline	All Officials	5 days	IAHE
New Technology Vision 2022	<ul style="list-style-type: none"> • The course covers the advancements in the new technologies in the road sector 	Online	All Officials	1 hr.	iGOT
Data Analytics using MS-Excel	<ul style="list-style-type: none"> • Data collection, compiling, circulating time series data and analysis 	Online	Up to SE level	4 hours 30 mins	iGOT
Project Management	<p>The following modules covers the topics -</p> <ul style="list-style-type: none"> • Identify steps in project management, • Augment where focus to be given for smart project management, • Assess the key issues in investment by taking up analytical exercises, • Know how social value is created through investment, and • Apply Randomized Controlled Trial (RCT) in project evaluation. 	Online	Up to EE level	1 hr 15 mins	iGOT

Project Management	<ul style="list-style-type: none"> The project management course covers stages involved in projects, with modules covering each stage with execution knowledge 	Offline	SE & above	4 Days	IAHE
--------------------	---	---------	------------	--------	------

5.3.1.5. EAP Zone

Some of the key focus areas of the EAP Zone –

- External funded project dealings – GNHCP & e-DAR
- Monitoring and development work

S. No.	Competency Assessment	Skills/Competency Related Intervention Suggested
1	Highway development including engineering, cost estimation, construction, and monitoring	<ul style="list-style-type: none"> Technical trainings on engineering, construction and monitoring of old/new road projects. For more exposure to on field learnings
2	Maintenance of National Highways including planning, engineering, implementation, and monitoring	<ul style="list-style-type: none"> Technical trainings for planning, engineering, and implementation activities Study of National highways, various schemes, planning modules etc.
3	Data analysis and processing	<ul style="list-style-type: none"> Training to analyse large amount of data for insights and decision making
4	Project Management, controlling and reporting including various project management tools and techniques.	<ul style="list-style-type: none"> Courses on project management Report writing Technical tools and skills for on job practices
5	Contract management and administration	<ul style="list-style-type: none"> Courses on contract management from IAHE/ ISTM Trainings on administrative norms and functions Special trainings on Karma yogi portal
6	Latest practices and technologies related to design, construction, maintenance & materials used in highways	<ul style="list-style-type: none"> Study of latest technologies New interventions in the road development field Best practices from neighboring countries Successful models of road projects

Thus, for the EAP Zone few suggested domain trainings are mentioned below.

Training Program	Modules Covered	Mode	Target Group	Duration	Knowledge Partner
Preparation of DPR for Highways Project	<ul style="list-style-type: none"> The course covers the step wise preparation of the DPR report of a project 	Offline	Up to SE Level	6 days	IAHE
Design, construction, Maintenance & Operations of Expressway	<ul style="list-style-type: none"> The training covers modules on design, construction and operations of National Highways and Expressway 	Offline	Up to SE Level	5 days	IAHE
Contract Management, Dispute Resolution and Arbitration in Highway Projects	<ul style="list-style-type: none"> The training covers modules on contract management, and dispute resolution as per rules set by the Government 	Offline	All Officials	5 days	IAHE
Good construction practices	<ul style="list-style-type: none"> The training covers modules on good practices adopted across the world 	Offline	All Officials	5 days	IAHE
New Technology	<ul style="list-style-type: none"> The course covers the advancements in 	Online	All Officials	1 hr.	iGOT

Vision 2022	the new technologies in the road sector				
Data Analytics using MS-Excel	<ul style="list-style-type: none"> Data collection, compiling, circulating time series data and analysis 	Online	Up to SE level	4 hours 30 mins	iGOT
Project Management	<p>The following modules covers the topics -</p> <ul style="list-style-type: none"> Identify steps in project management, Augment where focus to be given for smart project management, Assess the key issues in investment by taking up analytical exercises, Know how social value is created through investment, and Apply Randomized Controlled Trial (RCT) in project evaluation. 	Online	Up to EE level	1 hr 15 mins	iGOT
Project Management	<ul style="list-style-type: none"> The project management course covers stages involved in projects, with modules covering each stage with execution knowledge 	Offline	SE & above	4 Days	IAHE

5.3.2. Road Transport Wing

5.3.2.1. Motor Vehicle Legislation & Automotive Division

Some of the key focus areas of the MVL & Automotive Division–

- Motor Vehicles Legislation (including Motor Vehicle Act, Central Motor Vehicle Rules and Motor Vehicle Regulations) along with subsequent Amendments, Clarifications, and Examinations
- Automotive norms

S. No.	Competency Assessment	Skills/Competency Related Intervention Suggested
1	Motor Vehicles Act, 1988	<ul style="list-style-type: none"> Trainings for all officers to increase awareness on Motor Vehicle Act, 1988
2	Central Motor Vehicles Rules, 1989	<ul style="list-style-type: none"> Trainings for all officers to increase awareness on Central Motor Vehicles Rules, 1989
3	Applicable rules, regulations, notifications, and conventions for vehicular traffic	<ul style="list-style-type: none"> Trainings to be conducted for relevant rules, regulations and updates in the vehicular traffic system
4	Automotive norms plans and policies implementation, Automotive Industry Standards	<ul style="list-style-type: none"> Trainings on automotive norms and polices etc.
5	Automotive Testing standards and safety	<ul style="list-style-type: none"> Trainings to be conducted on automotive testing standards
6	e Emission guidelines, initiatives and policies related to emission reduction including alternate fuels etc.	<ul style="list-style-type: none"> Awareness of e-emissions guidelines for all officers
7	Global practices and innovation in automotive regulations, safety norms, testing norms etc.	<ul style="list-style-type: none"> Trainings for all officers to introduce new technical expertise and global innovation practices
8	World Forum for Harmonization of Vehicle Regulations mainly WP-29 Regulatory framework	<ul style="list-style-type: none"> Trainings for world forum regulations and other international forum rules, laws etc.
9	e-Transport Mission Mode Project and Citizen Centric Services such as Vahan, SARATHI, e-Challan etc.	<ul style="list-style-type: none"> Awareness of e- transport guidelines for all officers

Thus, for the MVL & Automotive Division few suggested domain trainings and exposure visits are mentioned below.

Training Program	Modules Covered	Mode	Target	Duration	Knowledge
------------------	-----------------	------	--------	----------	-----------

			Group		Partner
Motor Vehicle Act, 1988 – Guidelines & Related amendments	<ul style="list-style-type: none"> The online material provides the basic understanding of the Motor Vehicle Act, 1988 	Online	All Officials	Self-paced	Reading material
Course on Motor Vehicles Act 1988	<ul style="list-style-type: none"> The course provides the Motor Vehicle Act 1988 details Induction Training - To be provided at the time of joining the Wing/ Division 	Online	All Officials	6 hours	Unacademy
Central Motor Vehicle Rules, 1989 – MoRTH Website	<ul style="list-style-type: none"> The online material provides the Motor vehicle Rules 	Online	All Officials	Self-paced	Reading Material
Data Driven Decision Making	<ul style="list-style-type: none"> The course provides the Concepts of Data Collection, Cleaning, Analysis, and Interpretation 	Online	Up to DS Level	4 h 30 mins	Online on iGOT
Automotive Induction Course	<ul style="list-style-type: none"> The course provides technical modules related to automotive standards and advancement as per new technologies 	Offline	Scientist	5 days	Offline by CIRT
Automotive Industry Standard – Website MoRTH	<ul style="list-style-type: none"> Document provides essential knowledge for awareness of Automotive Industry standards 	Online	CE & Scientist	Self-paced	Reading Material
Automotive Testing & Certification by ARAI	<ul style="list-style-type: none"> Trainings to provide knowledge on automotive norms, industry standards etc. 	Offline	CE & Scientist	Self-paced	Offline (Pune)
Real driving emission	<ul style="list-style-type: none"> Trainings to provide introduction to RDE, adoption in Europe, testing methodologies and applications etc. 	Online	CE & Scientist	3 days	Online by ARAI
Training Program on Legislative Drafting	<ul style="list-style-type: none"> The training program covers the topics on legislative drafting 	Hybrid	Up to DS Level	25 days	Parliamentary Research and Training Institute for Democracies

Exposure Visits:

Some trainings for foreign exposure are listed below for senior officials of the MVL & Automotive Division -

Training	Location	Provider/ Facilitator	Proposed Duration	Proposed Attendees
EVI: Charging Ahead – Taking charge of Electric Vehicle Infrastructure	Glasgow Scotland	Institute of Highway Engineers	1 Week	CE (MVL)

5.3.2.2. Road Safety Division

Some of the key focus areas of the Road Safety Division -

- Road safety plans,
- Policies and schemes and
- Setting framework for mitigation measures

S. No.	Competency Assessment	Skills/Competency Related Intervention Suggested
--------	-----------------------	--

S. No.	Competency Assessment	Skills/Competency Related Intervention Suggested
1	Motor Vehicles Act, 1988	<ul style="list-style-type: none"> • Trainings for all officers to increase awareness on Motor Vehicle Act, 1988
2	Central Motor Vehicles Rules, 1989	<ul style="list-style-type: none"> • Trainings for all officers to increase awareness on Central Motor Vehicles Rules, 1989
3	Applicable rules, regulations, notifications, and conventions for vehicular traffic	<ul style="list-style-type: none"> • Trainings to be conducted for relevant rules, regulations and updates in the vehicular traffic system
4	Scrapping Facilities, Automated Testing Stations and similar initiatives	<ul style="list-style-type: none"> • Awareness of scrapping policies, and other similar citizen centric objectives
5	Road safety standards	<ul style="list-style-type: none"> • Trainings and courses on Road safety standards, 4 pillars of road safety, Road Safety Management, Road Safety Fund Management, road safety audit, blackspots, etc
6	Rules and regulations for setting driving schools/ institutes	<ul style="list-style-type: none"> • Trainings on rules & regulations for setting up driving schools
7	Latest Road Safety technologies (ITMS, ATMS, ABS, ADAS etc.)	<ul style="list-style-type: none"> • Courses on latest technologies for road safety for all officers, mainly on-site officers
8	Global Practices and innovations for performance management, improved efficiency and safety, services quality etc. in Road Transport Sector	<ul style="list-style-type: none"> • Trainings to be conducted on best global practices, innovations, • New technical developments
9	Analysis of road accident data and decision making	<ul style="list-style-type: none"> • Training for analysis of road accidents data for effective decision making

Thus, for the Road Safety Division few suggested domain trainings are mentioned below.

Training Program	Modules Covered	Mode	Target Group	Duration	Knowledge Partner
Motor Vehicle Act, 1988 – Guidelines & Related amendments	<ul style="list-style-type: none"> • The online material provides the basic understanding of the Motor Vehicle Act, 1988 	Online	All Officials	NA	Reading material
Course on Motor Vehicles Act 1988	<ul style="list-style-type: none"> • The course provides the Motor Vehicle Act 1988 details • Induction Training - To be provided at the time of joining the Wing/ Division 	Online	All Officials	NA	Unacademy
Central Motor Vehicle Rules, 1989 – MoRTH Website	<ul style="list-style-type: none"> • The online material provides the Motor vehicle Rules 	Online	All Officials	NA	Reading Material
Data Driven Decision Making	<ul style="list-style-type: none"> • The course provides the Concepts of Data Collection, Cleaning, Analysis, and Interpretation 	Online	Up to DS Level	4 h 30 mins	Online on iGOT
Global Road safety partnership (GRSP) – Resources, webinars, training materials on road safety	<ul style="list-style-type: none"> • The document guidelines on Global road safety practices and other relevant topics for road safety such as new advancements across world etc. 	Online	Up to DS Level	NA	Online
Data analytics, predictive analysis, artificial intelligence	<ul style="list-style-type: none"> • The course provides knowledge of data analytics practices, analysis of data for reports, using AI based softwares for precise analysis and data management. 	Offline	DS, AEE	3 days	ISTM
Road safety engineering & Auditing	<ul style="list-style-type: none"> • Purpose of Road Safety Audit • Road Safety Audit Stages • Key Steps in Road Safety Audit • Benefits of Road Safety Audit • Outline of RSA Report • Qualification & Experience of Road Safety Audit Team • Road Safety Inspection of Existing Roads 	Offline	AEE	5 days	IAHE

	Checklist for Road Safety Inspection			
--	--------------------------------------	--	--	--

5.3.2.3. Transport Division

Transport Division administers certain rules like Road Transport Corporation, 1950, Carriers Act, 1965, Carriage by Roads Act, 2007. Along with enforcing the laws, it also formulates the Budget and Annual Five-Year Plan of Road Transport Wing. Studying and researching about the Indian transport sector and takes up certain matters relating to some of the governmental organization like CIRT, Pune, Association of State Road Transport Undertakings.

S. No.	Competency Assessment	Skills/Competency Related Intervention Suggested
1	Policy formulation for all the new schemes, new programs related to Road Transport Sector	<ul style="list-style-type: none"> • Trainings to be provided on policy making, public policy formulation and implementation of policies in roads and transport sector
2	Road Transport Corporations Act, 1950	<ul style="list-style-type: none"> • Trainings on Road Transportation Act, 1950
3	Carriage by Road Act, 2007	<ul style="list-style-type: none"> • Trainings on Carriage by Road Act, 1950
4	Assessment of performance of Road Transport schemes and prepare improvement	<ul style="list-style-type: none"> • Trainings on performance of Road Transport and schemes, monitoring of schemes, evaluations of schemes
5	Applicable rules, regulations, notifications, and conventions for vehicular traffic	<ul style="list-style-type: none"> • Trainings to be conducted for relevant rules, regulations and updates in the vehicular traffic system
6	Preparation of departmental action plans for Road Transport, conceptualization & implementation of awareness weeks, campaigns etc.	<ul style="list-style-type: none"> • Trainings to prepare plans, concept notes, implementation framework and other administrative and office procedures
7	Sustainable transport and circular economy (emission reduction targets & means, waste reduction etc.	<ul style="list-style-type: none"> • Trainings on sustainable developments in transports
8	Scrapping Facilities, Automated Testing Stations and similar initiatives	<ul style="list-style-type: none"> • Awareness of scrapping policies, and other similar citizen centric objectives
9	Programs of other Ministries related to Road Transport such a National Electric Bus Program. PLI Scheme etc.	<ul style="list-style-type: none"> • Trainings and courses on Programs related to transport for knowledge enhancement
10	Global Practices and innovations for performance management, improved efficiency and safety, services quality etc. in Road Transport Sector	<ul style="list-style-type: none"> • Trainings to be conducted on best global practices, innovations, • new technical developments
11	ASRTU functions and operations	<ul style="list-style-type: none"> • Trainings on ASRTU functions and operations for all officers

Thus, for the Transport Division few suggested domain trainings and exposure visits are mentioned below.

Training Program	Modules Covered	Mode	Target Group	Duration	Knowledge Partner
Policy Making Programme	<ul style="list-style-type: none"> • Training covers basic of public policy, policy formulation, impact of policy and challenges in different sectors 	Online	Director and above	12 weeks	ISB
Basics of Public Policy	<ul style="list-style-type: none"> • The course provides a range of strategies and methods to design and formulate public policy 	Online	Up to Director Level	2 hrs. 48 mins	iGOT
Road Transport Corporation Act, 1950 – India Code Website	<ul style="list-style-type: none"> • The online material provides the Road Transport Corporation Act, 1950 	Online	Up to Director Level	NA	Reading Material

Carriage by Road Act, 2007 – MoRTH Website	<ul style="list-style-type: none"> The online material provides the Carriage Road Act, 2007 	Online	Up to Director Level	NA	Reading Material
Monitoring & Evaluation of Government Schemes	This course covers basic understanding of how to cover monitoring and evaluation of government schemes	Online	Up to Director Level	1 day	ISTM
Data Driven Decision Making	<ul style="list-style-type: none"> The course provides the Concepts of Data Collection, Cleaning, Analysis, and Interpretation 	Online	Up to Director Level	4 h 30 mins	iGOT
Monitoring & Evaluation of Government Schemes (Group “A” / Up to Gr. “B” Officers)	<ul style="list-style-type: none"> This course provides advanced level content on Monitoring of ongoing schemes and evaluation of performances, especially for Group A and B officers 	Online	Up to Director Level	1 day	ISTM
Sustainability, Economics climate resilience	<ul style="list-style-type: none"> The training provides details on importance of sustainable practices, climate centric approach for developments. 	Online	Director and above	NA	iGOT

Exposure Visits:

Some trainings for foreign exposure are listed below for senior officials of the Transport Division -

Training	Location	Provider/ Facilitator	Proposed Duration	Proposed Attendees
Knowledge and Experience sharing Program (For international Cooperation in Korea)	Korean Road Association International Road Center	Korean Road Association	1-2 weeks	Director and above

5.3.3. Highways Wing

5.3.3.1. Highways Division

Some of the key focus areas of the Highways Division -

- NHA related matters
- Implementation of projects and proposals
- Cabinet Matters
- Highway construction and maintenance Reporting

S. No.	Competency Assessment	Skills/Competency Related Intervention Suggested
1	Knowledge of highway constructions (Designing and Planning), and Land Acquisition related matters	<ul style="list-style-type: none"> Trainings to be provided on highway construction technologies, which covers essentials modules for officers such as designing, and other matters related to land clearances, environment clearances.
2	Highway engineering, highway maintenance, quality etc.	<ul style="list-style-type: none"> Trainings to be identified on highway engineering, highway maintenance and other quality and control matters for on field officers. Awareness trainings to be conducted for all officers to increase domain expertise
3	Processing of draft note for Cabinet Committee on Economic Affairs (CCEA) in respect of projects which are	<ul style="list-style-type: none"> Trainings on effective noting and drafting for cabinet matters to be conducted for all officers

S. No.	Competency Assessment	Skills/Competency Related Intervention Suggested
	implemented by National Highways Authority of India (NHAI) for necessary approvals	
4	Public Private Partnerships models, (DBFOT, HAM, TOT etc.), Model Concession Agreements, policies and regulations and related laws	<ul style="list-style-type: none"> Knowledge trainings for all officers on PPP models, investment, future scope, policy formulation to be provided to all officers to enhance domain knowledge
5	Implementation of Greenfield / Brownfield projects	<ul style="list-style-type: none"> Trainings on greenfield and brownfield projects
6	Understanding of Detailed Project Report (DPR)	<ul style="list-style-type: none"> Trainings for step by step preparation of DPR to be conducted for all technical officers such as AEE/EE/SE and CE
7	Environmental Impact Assessment and environmental Management Plan	<ul style="list-style-type: none"> Trainings to be provided for courses on Environmental Impact assessment, environmental clearances including other land related matters to officers performing on site duties. On field trainings to be provided for proper execution
8	Management of Special Infrastructural Projects which are under "Bharatmala Pariyojna" of National Highways Development	<ul style="list-style-type: none"> Trainings to be provided on project management, contract management for execution of National highways projects
9	Project (NHDP) or under Special Projects category	<ul style="list-style-type: none"> Awareness of NHDP and special category projects
10	Contract management and administration	<ul style="list-style-type: none"> Special trainings on contract management and office procedures for officers of all designations
11	Arbitration and dispute resolution	<ul style="list-style-type: none"> Trainings on rules for arbitration and dispute resolution as per government standards and guidelines
12	Latest practices and technologies related to design, construction, maintenance & materials used in highways	<ul style="list-style-type: none"> Trainings to be provided to latest / best practices to be adopted

Thus, for the Highways Division few suggested domain trainings and exposure visits are mentioned below.

Training Program	Modules Covered	Mode	Target Group	Duration	Knowledge Partner
Preparation of DPR for Highways Project	<ul style="list-style-type: none"> The course provides the steps to prepare a DPR Induction Course at the time of joining the Wing/ Division 	Offline	EE, AEE	6 Days	IAHE
Effective Cabinet Notes – up to Group A officers	<ul style="list-style-type: none"> This course provides topics on effective noting and drafting for senior officers 	Online	All Officials	1 Day	ISTM
PPP for infrastructure projects	<ul style="list-style-type: none"> The course provides knowledge of infrastructure project, future scope and investments 	Online	Up to DS level	2 hrs 24 mins	iGoT
Basics of Climate Change	<ul style="list-style-type: none"> The course provides new innovation to help in climate change and how individuals should act 	Online	Up to DS level	2 hrs 11 mins	iGOT
Economics of climate resilient development	<ul style="list-style-type: none"> The course provides how in this course, you will learn the basics on how economically viable climate-resilient development plans are developed. 	Online	Up to DS level	1 hr 21 mins	iGOT
Procurement of services, work, and contract management	<ul style="list-style-type: none"> This Course provides detailed knowledge about Procurement of Services, Works, and Contract Management in rural roads construction 	Online	Up to DS level	20 hrs	iGOT

Contract Management & Dispute resolution	<ul style="list-style-type: none"> The course provides the knowledge of contract management and the process of dispute resolution set by the government 	Offline	AS, DS, EE, AEE	5 days	IAHE
Data analytics, predictive analysis, artificial intelligence	<ul style="list-style-type: none"> The training program will provide necessary skill set for data-based analysis; AI based technologies etc. 	Online	US, EE, AEE, SO, ASO	4 hrs 30 mins	iGOT
Right of way and land use	<ul style="list-style-type: none"> Online material on MoRTH website 	Online	Up to DS level	Self-paced	-
New Technology Vision 2022	<ul style="list-style-type: none"> The course covers the advancements in the new technologies in the road sector 	Online	All Officials	1 hr.	iGOT

Exposure Visits:

Some trainings for foreign exposure are listed below for senior officials of the Highways Division -

Training	Location	Provider/ Facilitator	Proposed Duration	Proposed Attendees
Highway and Structure Construction and Maintenance	USA	Federal Highway Administration	3 days	DS & above

5.3.3.2. Land Acquisition Division

Some of the key focus areas of the Land Acquisition Division -

- Acts and amendments (Right to fair Compensation and transparency in Land Acquisition, Rehabilitation and Resettlement Act, 2013)
- Land Acquisition Manual
- National Highways Control Act,2002 etc.) / guidelines related to land acquisition matters.
- Laws, Rules, Guidelines processes related to Environment/Forests/Wildlife Clearances for highway projects.
- Managing field inspections of land
- National Highway Tribunal
- Matters related to Highway Administration

S. No.	Competency Assessment	Skills/Competency Related Intervention Suggested
1	Acts and amendments (Right to fair Compensation & transparency in Land Acquisition, Rehabilitation and Resettlement Act, 2013)	<ul style="list-style-type: none"> Awareness of Acts, Rules and regulations for all employees
2	Land Acquisition Manual	<ul style="list-style-type: none"> Knowledge of Land Acquisition manual for awareness of day-to-day domain specific activities
3	National Highways Control Act,2002 etc.) / guidelines related to land acquisition matters	<ul style="list-style-type: none"> Trainings on National Highways covering Acts, rules and regulations related to land acquisition matters. Modules to also include technical aspects of highways and land related matters
4	Laws, Rules, Guidelines processes related to Environment/Forests/Wildlife Clearances for highway projects	<ul style="list-style-type: none"> Trainings on laws, rules, and government set guidelines for land usage for highway projects. Trainings on environmental clearance processes

S. No.	Competency Assessment	Skills/Competency Related Intervention Suggested
5	Managing field inspections of land	<ul style="list-style-type: none"> • Trainings for field inspections • On field opportunities for employees to learn more • More practical trainings for conducting on field surveys and studies
6	Matters related to Highway Administration	<ul style="list-style-type: none"> • Trainings on highway administration for in depth knowledge of project management, contract management and other relevant technical skills • On field trainings

Thus, for the Land Acquisition Division few suggested domain trainings are mentioned below.

Training Program	Modules Covered	Mode	Target Group	Duration	Knowledge Partner
Land Acquisition, Rehabilitation & Resettlement	<ul style="list-style-type: none"> • Trainings on Land Acquisition procedures, rehabilitation, and resettlement issues (Kenya) 	Offline	DS & above	10 days	Indepth Research Institute Via United Nations
Land Acquisition Act - Ministry of law and justice website	<ul style="list-style-type: none"> • Awareness of Land Acquisition Act for all officers for clear knowledge of the domain 	Online	All Officials	NA	-
Land acquisition Manual - MoRTH Website	<ul style="list-style-type: none"> • Awareness of Land Acquisition Manual 	Online	All Officials	NA	-
Related Acts/Rules - MoRTH Website	<ul style="list-style-type: none"> • Awareness of relevant acts/ rules in practice 	Online	All Officials	NA	-
Economics of climate resilient development	<ul style="list-style-type: none"> • Laws, Rules, Guidelines processes related to Environment/Forests/Wildlife Clearances for highway projects 	Online	Up to DS level	NA	iGOT
Contract Management & Dispute resolution	<ul style="list-style-type: none"> • Contract management and administration • Arbitration and dispute resolution 	Offline	DS and above	5 days	IAHE

5.3.4. Logistics Section

Some of the key focus areas of the Logistics Section –

- Civil engineering knowledge for logistics parks
- National Logistics Policy etc.
- Multi Modal Logistics Parks – objectives, benefits, target beneficiaries, eligibility, and implementation of projects MMLP
- Commercial Operations of MMLPs
- Logistics Efficiency Enhancement Program (LEEP)
- Project Management, controlling and reporting including various project management tools and techniques.
- Freight Logistics and Transportation including various business models (Hub & Spoke, Point to Point), multimodal operations, etc.
- Ropeway engineering, technologies, and operations
- Public Private Partnership Models (Design, Build, Finance, Operate and Transfer (DBFOT) mode)

S. No.	Competency Assessment	Skills/Competency Related Intervention Suggested
1	Civil engineering knowledge for logistics parks	<ul style="list-style-type: none"> • Training modules on Civil engineering technical knowledge • Modules on logistic parks and their operations • Supply chain management • Trainings for on field activities
2	National Logistics Policy etc.	<ul style="list-style-type: none"> • Awareness of National Logistics policy • Documented material for new joiners and other officers in position
3	Multi Modal Logistics Parks - objectives, benefits, target beneficiaries, eligibility, and implementation of projects MMLP	<ul style="list-style-type: none"> • Trainings on MMLPs, related laws and guidelines set by government. • Operational management modules to learn the functioning of MMLP
4	Commercial Operations of MMLPs	<ul style="list-style-type: none"> • Training modules for technical and commercial operations of logistics parks
5	Logistics Efficiency Enhancement Program (LEEP)	<ul style="list-style-type: none"> • Knowledge and awareness program for efficiency enhancement in the field of logistics
6	Project Management, controlling and reporting including various project management tools and techniques.	<ul style="list-style-type: none"> • Trainings to be provided on the project management, contract management and other related tools to increase the on job understanding of the duties
7	Freight Logistics and Transportation including various business models (Hub & Spoke, Point to Point), multimodal operations, etc.	<ul style="list-style-type: none"> • Modules on freight logistics • Transportation and supply chain management • Operational management of multimodal parks
8	Ropeway engineering, technologies, and operations	<ul style="list-style-type: none"> • Courses on ropeway engineering • Technologies for ropeway engineering • Operations for ropeways • Previous studies on ropeways and successful models
9	Public Private Partnership Models (Design, Build, Finance, Operate and Transfer (DBFOT) mode)	<ul style="list-style-type: none"> • Knowledge and awareness of scope of PPP • Other relevant models of development • Scope of investment and returns through PPP

Thus, for the Logistics Section few suggested domain trainings and exposure visits are mentioned below.

Training Program	Modules Covered	Mode	Target Group	Duration	Knowledge Partner
PM Gati Shakti Training	<ul style="list-style-type: none"> • The training covers modules on supply chain, multimodal transport management, shipping logistics, warehouse automation etc. • Induction Training - To be provided at the time of joining the Wing/ Division 	Online	All Officials	35 hours	iGOT
Supply Chain & Demand Analytics	<ul style="list-style-type: none"> • The modules cover supply chain basics concepts, and the integration of data analytics for the supply chain management and operations 	Online	Director and above	Self-paced learning	Nite / IIM Mumbai
Logistics Efficiency Enhancement Program (LEEP) – MoRTH Website	<ul style="list-style-type: none"> • The LEEP program includes Freight management, freight operations and various freight models. 	Online	All Officials	Self-paced learning	-
PPP for infrastructure projects	<ul style="list-style-type: none"> • Public Private Partnerships models, Model Concession Agreements, policies and regulations and related laws 	Online	Up to Director level	2 hours 24 mins	iGOT
Project Management	<ul style="list-style-type: none"> • The trainings involve concepts of project management, operations, functions, project deliveries etc. 	Offline	SE and above	4 days	IAHE

Freight Business	<ul style="list-style-type: none"> It covers freight operations, basic operating models etc. 	Online	All Officials	1 hr 7 mins	iGOT
------------------	---	--------	---------------	-------------	------

Exposure Visits:

Some trainings for foreign exposure are listed below for senior officials of the Logistics Section -

Training	Location	Provider/ Facilitator	Proposed Duration	Proposed Attendees
Ropeway Infrastructure and operations	Austria	Ropeway Training Centre, Dornbirn	Hybrid Mode, the duration may vary as per the selected modules of the course	Director and above

5.3.5. Toll Division

Some of the key focus areas of the Toll Division -

- User Fee (Toll)
- Related policies
- Electronic Toll Collection (ETC) System
- Preparation of or modification of User Fee (Toll) policies or regulations, according to Cabinet
- Managing complaints against user fees brought up by various transport organizations, including the All-India Motor Transport Congress and the All-India
- Managing user fee concerns with the NHAI, other departments, and state government
- Implementation of Electronic Toll Collection System
- Policy matters relating to Wayside Amenities
- Global practices and innovation in the domain

S. No.	Competency Assessment	Skills/Competency Related Intervention Suggested
1	Policy / Rule drafting on the domain	<ul style="list-style-type: none"> Trainings / workshops on policy formulation and drafting to increase officers' efficiency for better governance roles
2	Acts, Laws, rules, guidelines, notifications, and amendments on matter related to land, user fee, toll collection etc.	<ul style="list-style-type: none"> Trainings on Acts, laws, and other relevant guidelines Modules on current toll policies and laws
3	Preparation of or modification of User Fee (Toll) policies or regulations, according to Cabinet	<ul style="list-style-type: none"> Trainings to prepare the User Fee policies, amendments etc.
4	Managing complaints against user fees brought up by various transport organizations, including the All-India Motor Transport Congress and the All-India	<ul style="list-style-type: none"> Courses on handling complaints matters. Knowledge of various transport organizations
5	Managing user fee concerns with the NHAI, other departments, and state government	<ul style="list-style-type: none"> Trainings to prepare the User Fee policies, amendments etc.
6	Implementation of Electronic Toll Collection System	<ul style="list-style-type: none"> Training modules to learn the electronic tolling system. Implementation processes
7	Policy matters relating to Wayside Amenities	<ul style="list-style-type: none"> Trainings / workshops on policy formulation and drafting to increase officers' efficiency for better governance roles. Modules on understanding way side amenities
8	Global practices and innovation in the domain	<ul style="list-style-type: none"> Training modules to learn the best practices from neighboring countries. Learnings of successful business models for

S. No.	Competency Assessment	Skills/Competency Related Intervention Suggested
		toll and collection system across world

Thus, for the Toll Division few suggested domain trainings and exposure visits are mentioned below.

Training Program	Modules Covered	Mode	Target Group	Duration	Knowledge Partner
Formulation of public policy	<ul style="list-style-type: none"> The course provides the steps for formulation of public policies 	Online	All Officials	1 hr 15 mins	iCOT
Circulars on amendments in the policy/User Fee/ SOPs – MoRTH Website	<ul style="list-style-type: none"> The document provides the amendments in the policy/ user fees 	Online	All Officials	NA	Reading Material
Gazette Notifications – NH User Fee Toll (MoRTH Website)	<ul style="list-style-type: none"> The document provides the Gazette notifications NH User Fees Toll 	Online	All Officials	NA	Reading Material
Intelligent Transport System (ITS) and Electronic Toll Collection (ETC)	<ul style="list-style-type: none"> The course provides trainings on Intelligent Transport system and electronic toll collection system. Several modules are covered for related topics 	Offline	Up to SE level	3 Days	IAHE
Policy Guidelines for Development of wayside amenities – Website – MoRTH	<ul style="list-style-type: none"> The training modules provides the policy development guidelines and provides topics on way side amenities 	Online	Up to SE level	NA	Reading Material
Data analytics, predictive analysis, artificial intelligence	<ul style="list-style-type: none"> The course provides knowledge of data analytics practices, analysis of data for reports, using AI based software for precise analysis and data management. 	Offline	Up to SE level	3 days	ISTM

Exposure Visits:

Some trainings for foreign exposure are listed below for senior officials of the Toll Division –

Training	Location	Provider/ Facilitator	Proposed Duration	Proposed Attendees
Knowledge and Experience sharing Program (For international Cooperation in Korea)	Korean Road Association International Road Center	Korean Road Association	1-2 weeks	SE and above

5.3.6. International Cooperation (IC) Division

Some of the key focus areas of the IC Division –

- Bilateral relations
- MoUs
- Meetings with International delegates
- New projects/ plans

S. No.	Competency Assessment	Skills/Competency Related Intervention Suggested
1	Diplomacy and negotiation skills	• Training on bilateral relations, negotiations and diplomacy
2	Policy development and analysis	• Trainings to be provided on policy making, public policy formulation and implementation of policies
3	Strategic international planning and foreign management	• Training on international collaboration
4	Cross function collaboration	
5	Knowledge of international forums	• Induction material on international treaties, agreements, laws and regulations
6	Compliance and legal knowledge	
7	Knowledge of international agreements etc.	

Thus, for the IC Division few suggested domain trainings are mentioned below.

Training Program	Modules Covered	Mode	Target Group	Duration	Knowledge Partner
Guidelines/SoP on the conclusion of International Treaties in India	• Drafting and negotiation	Reading material/ Online	All Officials	Self-paced	Ministry of External Affairs (MEA)
Bilateral Policy Coordination Training	• International Cooperation & coordination • Bilateral collaboration	Physical	Director & above	4 weeks	JICA, SCPTA, IMF
Policy Making Programme	• Training covers basic of public policy, policy formulation, impact of policy and challenges in different sectors	Online	US and above	12 weeks	ISB
International treaties/ agreements	• Various treaties, laws and agreements signed with other countries	Reading material/ Online	All Officials	Self-paced	MEA, MoTRH

5.3.7. Finance Wing

Some of the key focus areas of the Finance Wing –

- The key focus areas of Finance Wing are as follows –
- Financial Planning
- Budgeting
- Treasury
- Cash Management
- Accounting and Accounting Standards
- Delegation of Financial Power Rules (DFPR), an indicator of overall expanse of duties and responsibilities of Financial Advisor
- Manage BE/RE proposals from different administrative units.
- FRBM Act, presenting disclosure statements against parliament, this would include collection of requisite information and material inputs from FMs to understand fiscal situation.
- Issuance of Fund Availability Certificates
- Financial management which includes schematic appraisal and concept functions, revenue management, fiscal resource transfer issues etc.

- Internal Extra Budgetary Resources (IEBR)
- Various portals such as PFMS etc.

S. No.	Competency Assessment	Skills/Competency Related Intervention Suggested
1	Financial Planning	<ul style="list-style-type: none"> • Training modules to learn financial planning for MDO functional tasks, budget estimates, revised estimates, GFR Rules etc.
2	Budgeting	<ul style="list-style-type: none"> • Trainings to learn budgeting of matters related to government, processes, and implementation methods
3	Treasury	<ul style="list-style-type: none"> • Courses on managing tasks related to treasury for all officers and new joiners. • Training modules on collection, management, and expenditure of public revenues
4	Cash Management	<ul style="list-style-type: none"> • Trainings on collecting and managing cash flows
5	Accounting and Accounting Standards	<ul style="list-style-type: none"> • Trainings for new joiners and officers in position to understand the accounting procedures and standards
6	Delegation of Financial Power Rules (DFPR), an indicator of overall expanse of duties and responsibilities of Financial Advisor	<ul style="list-style-type: none"> • Awareness of DFPR for new joiners and officers in position to understand the delegation of financial powers
7	Manage BE/RE proposals from different administrative units	<ul style="list-style-type: none"> • Modules to understand the budgeting in the organization. • Understanding the revenue expenditure and budget quotations
8	FRBM Act, presenting disclosure statements against parliament, this would include collection of requisite information and material inputs from FMs to understand fiscal situation	<ul style="list-style-type: none"> • Modules on FRBM Act • Courses to understand the fiscal operations, macroeconomic functions, matters related to public policy, budget, and fiscal frugality.
9	Issuance of Fund Availability Certificates	<ul style="list-style-type: none"> • Trainings / Workshops on issues of funds availability certificates • Understanding of legal framework for fiscal consolidation
10	Financial management which includes schematic appraisal and concept functions, revenue management, fiscal resource transfer issues etc.	<ul style="list-style-type: none"> • Trainings on Fiscal management, resource transfer issues, appraisals etc.
11	Regulatory framework for fund attraction from private sector	<ul style="list-style-type: none"> • Training to understanding of legal framework for fiscal consolidation
12	Internal Extra Budgetary Resources (IEBR)	<ul style="list-style-type: none"> • Trainings to understand the central plans of government of India. • Financial Planning to understand various PSUs achieve their financial targets
13	Various portals such as PFMS etc.	<ul style="list-style-type: none"> • Trainings to use PFMS portals for new joiners and officers in positions as a refresher training

Thus, for the Finance Wing few suggested domain trainings are mentioned below.

Training Program	Modules Covered	Mode	Target Group	Duration	Knowledge Partner
Financial Accounting and Analysis (IIM Bangalore)	<ul style="list-style-type: none"> • The training involves basics of financial accounting and analysis. • It covers theoretical knowledge for domain specific activities 	Online	Up to DS Level	Self-paced learning	Swayam
Budgeting, accounting, and financial management in government sector -	<ul style="list-style-type: none"> • The course covers budgeting, accounting and topics on financial management in government sector such as government schemes etc. 	Offline	Up to DS Level	Self-paced learning	NIFM

NIFM					
Public Finance & Government Accounting – ICAI	<ul style="list-style-type: none"> The course covers modules on public finance and government accounting rules 	Offline	DS & above	1 week	ICAI
Cash & Accounts	<ul style="list-style-type: none"> The course covers basic topics on cash and accounts management in a government MDO 	Offline	Up to US Level	9 weeks	ISTM
Workshop on Preparation of Expenditure Finance Committee/Standing Finance Committee	<ul style="list-style-type: none"> The workshop covers a holistic knowledge on expenditure Finance committee and standing finance committee 	Online	DS & above	2 Days	ISTM
Fiscal Responsibility & Budget Management Act and Rules	<ul style="list-style-type: none"> The course covers rules and acts on Budget management and fiscal responsibility 	Online	US & DS	Self-paced learning	DEA website
Public Financial Management (PFMx)	<ul style="list-style-type: none"> The course covers Public Finance management, financial analysis, financial assessments. 	Online	DS and above	Self-paced learning	IMF
Workshop on Public Private Partnership	<ul style="list-style-type: none"> The course covers details on PPP, various PPP models in infrastructure domain. 	Online	DS & above	2 Days	ISTM
Orientation Training Programme on PFMS	<ul style="list-style-type: none"> The course covers operational training of the government PFMS portal 	Online	US, SO, ASO	2 Days	ISTM

5.3.8. Administration Wing

5.3.8.1. Establishment-I (E-I) Section

Some of the key focus areas of the EI Section –

- All administrative matters of all Officers and Staff of this Ministry including staff of Hon'ble Minister and Hon'ble Minister of State but excluding CSSS and MTS

S. No.	Competency Assessment	Skills/Competency Related Intervention Suggested
1	Understanding of all service matters of officers/officials of MoRTH	<ul style="list-style-type: none"> Training/ induction material of relevant rules/policies related to service matter of officers
2	Awareness of matters pertaining to grant of permission for medical treatment/investigations from recognised CGHS hospitals/Centres, etc. for government officials	<ul style="list-style-type: none"> Training/ induction material related to CGHS scheme
3	Awareness of CSS rules to handle disciplinary matters	<ul style="list-style-type: none"> Training on CSS rules
4	Managing applications for government accommodations, travels etc.	<ul style="list-style-type: none"> Induction material related to government accommodations, travels etc.
5	Awareness of CSMOP manual	<ul style="list-style-type: none"> Training of knowledge of CSMOP manual

Thus, for the EI Section few suggested domain trainings are mentioned below.

Training Program	Modules Covered	Mode	Target Group	Duration	Knowledge Partner
Office Procedures	<ul style="list-style-type: none"> Manual of Office Procedures, All India Services (AIS) Manuals and Central Civil Services (CCS) Rules and other service 	Online	DS & below	1 hr 15 mins	iGOT

	<ul style="list-style-type: none"> rules Induction Training - To be provided at the time of joining the Wing/ Division 				
CSS LTC Rules	<ul style="list-style-type: none"> LTC/TA Rules/ etc. 	Reading material	All Officials	Self-paced	DoPT
Leave Rules	<ul style="list-style-type: none"> Leave Rules /International cooperation Guidelines / Deputation Rules etc. 	Reading material	All Officials	Self-paced	MoRTH
CSMOP Manual	<ul style="list-style-type: none"> Regulations and guidelines issued by DAR&PG and DOPT for trainings, transfers, upskilling and hiring procedures. 	Reading material	All Officials	Self-paced	DARPG
Fundamental Rules & Supplementary Rules	<ul style="list-style-type: none"> Appointment, leave, 	Online	US & below	Self-paced	ISTM

5.3.8.2. Establishment-IB (E-IB) Section

Some of the key focus areas of the EIB Section –

- All administrative matter of all process of CSSS and MTS,
- Maintenance of Annual Performance Appraisal Reports (APARs) and Annual Immovable Property Returns (AIPRs) of all Officers and Staff

S. No.	Competency Assessment	Skills/Competency Related Intervention Suggested
1	Awareness of CSS Rules	<ul style="list-style-type: none"> Training/ induction material of CSSS Rules
2	Knowledge of maintenance of APAR reports for the officials	<ul style="list-style-type: none"> Training/ induction material related to CGHS scheme
3	Rules for deployment of invigilation duties for government activities such as competitive exams etc.	<ul style="list-style-type: none"> Training/ Induction material on deployment of officials for invigilating duties
4	Managing applications for government accommodations, travels etc.	<ul style="list-style-type: none"> Induction material related to government accommodations, travels etc.
5	Awareness of CSMOP manual	<ul style="list-style-type: none"> Training of knowledge of CSMOP manual

Thus, for the EIB Section few suggested domain trainings are mentioned below.

Training Program	Modules Covered	Mode	Target Group	Duration	Knowledge Partner
Office Procedures	<ul style="list-style-type: none"> Manual of Office Procedures, All India Services (AIS) Manuals and Central Civil Services (CCS) Rules and other service rules Induction Training - To be provided at the time of joining the Wing/ Division 	Online	DS & below	1 hr 15 mins	iGOT
CSS LTC Rules	<ul style="list-style-type: none"> LTC/TA Rules/ etc. 	Reading material	All Officials	Self-paced	DoPT
Leave Rules	<ul style="list-style-type: none"> Leave Rules /International cooperation Guidelines / Deputation Rules etc. 	Reading material	All Officials	Self-paced	MoRTH
CSMOP Manual	<ul style="list-style-type: none"> Regulations and guidelines issued by DAR&PG and DOPT for trainings, transfers, upskilling and hiring procedures. 	Reading material	All Officials	Self-paced	DARPG
Development of Attitude	<ul style="list-style-type: none"> Code of Conduct for Government Employees Noting and Drafting Public 	Hybrid	US & below	15 Days	iGOT and ISTM

Knowledge Skill for Holistic Transformation in Administration (DAKSHTA)	Procurement Framework of GOI Office Procedure Parliamentary Procedures Government E Marketplace Right to Information Act, 2005 - Part 1 Right to Information Act, 2005 - Part 2 Leave Rules Pay Fixation Annual Performance Appraisal Report (APAR)				
Fundamental Rules & Supplementary Rules	<ul style="list-style-type: none"> Appointment, leave, 	Online	US & below	Self-paced	ISTM

5.3.8.3. Establishment-II (E-II) Section

Some of the key focus areas of the EII Section –

- Matters related to Officers of Central Engineering Services (Roads) [CES(Roads)]

S. No.	Competency Assessment	Skills/Competency Related Intervention Suggested
1	Awareness of Recruitment rules for the Central engineering Service (Roads) Group "A" and General Central Service Group "B" "C" and "D" posts.	<ul style="list-style-type: none"> Training/ Induction material related to rules for CES
2	Knowledge of FR 56 (i) and Rule 48 of CCS Pension Rules	<ul style="list-style-type: none"> Training on FR 56 (i) and Rule 48 of CCS Pension Rules
3	Awareness of Delegation of Financial Powers to the ROs/ELOs.	<ul style="list-style-type: none"> Training on Delegation of Financial Powers, APAR etc.
4	Formulation of the annual training plans	
5	Awareness of APAR, deputation matters and transfers	

Thus, for the EII few suggested domain trainings and exposure visits are mentioned below.

Training Program	Modules Covered	Mode	Target Group	Duration	Knowledge Partner
LTC Rules	<ul style="list-style-type: none"> LTC/TA Rules/ etc. 	Reading material	All Officials	Self-paced	DoPT
Leave Rules	<ul style="list-style-type: none"> Leave Rules /International cooperation Guidelines / Deputation Rules etc. 	Reading material	All Officials	Self-paced	MoRTH
CSMOP Manual	<ul style="list-style-type: none"> Regulations and guidelines issued by DAR&PG and DOPT for trainings, transfers, upskilling and hiring procedures. 	Reading material	All Officials	Self-paced	DARPG
Development of Attitude Knowledge Skill for Holistic Transformation in Administration (DAKSHTA)	<ul style="list-style-type: none"> Code of Conduct for Government Employees Noting and Drafting Public Procurement Framework of GOI Office Procedure Parliamentary Procedures Government E Marketplace Right to Information Act, 2005 - Part 1 Right to Information Act, 2005 - Part 2 Leave Rules Pay Fixation Annual Performance Appraisal Report (APAR) 	Hybrid	US & below	15 Days	iGOT and ISTM
Service Rules of CES (Roads)	<ul style="list-style-type: none"> Method of recruitment, seniority, probation, training, pay scale etc. 	Reading Material	All Officials	Self-paced	MoRTH
Fundamental Rules & Supplementary	<ul style="list-style-type: none"> Appointment, leave, 	Online	US & below	Self-paced	ISTM

Rules					
-------	--	--	--	--	--

5.3.8.4. Establishment-IIB (E-IIB) Section

Some of the key focus areas of the EIIB –

- Appointment of Chairman and matters in NHA1,
- Framing and amendment of Rules and Regulations for appointment of Chairman, Members,
- Routine administration of NHA1

S. No.	Competency Assessment	Skills/Competency Related Intervention Suggested
1	Rules for appointment of chairman	• Induction material related to appointment of chairman
2	Awareness of Recruitment rules	• Induction material related to Recruitment rules
3	Knowledge of FR 56 (i) and Rule 48 of CCS Pension Rules	• Induction material related to Knowledge of FR 56 (i) and Rule 48 of CCS Pension Rules
4	Awareness of handling administrative matters of NHA1	• Induction material related to administrative matters of NHA1
5	Awareness of DoPT guidelines for officer trainings	• Induction material related to DoPT guidelines for officer trainings

Thus, for the EIIB Section few suggested domain trainings are mentioned below.

Training Program	Modules Covered	Mode	Target Group	Duration	Knowledge Partner
NHA1 Act, 1988	• Constitution, members, chairman, appointment etc.	Reading Material	All Officials	Self-paced	MoRTH
NHA1 Rules 1990	• Budget, Accounts, Audit, Investment of Funds, and Powers to enter premises	Reading Material	All Officials	Self-paced	MoRTH
DoPT guidelines for officer trainings	• Guidelines for officer trainings	Reading Material	All Officials	Self-paced	DoPT
Fundamental Rules & Supplementary Rules	• Appointment, leave,	Online	US & below	Self-paced	ISTM

5.3.8.5. General Section

Some of the key focus areas of the General Section –

- Procurement
- Distribution
- Maintenance
- Supervision

S. No.	Competency Assessment	Skills/Competency Related Intervention Suggested
1	Awareness of CSMOP manual	• Training/ induction material on CSMOP Manual
2	Awareness of matters related to maintenance, purchasing	• Induction material

S. No.	Competency Assessment	Skills/Competency Related Intervention Suggested
	of office equipment of the Ministry	
3	Knowledge of GPF withdrawal and advances	<ul style="list-style-type: none"> Training on General Provident Fund (GPF)
4	Knowledge of budget management	<ul style="list-style-type: none"> Training on budget management

Thus, for the General Section few suggested domain trainings are mentioned below.

Training Program	Modules Covered	Mode	Target Group	Duration	Knowledge Partner
BHC-012: Event Planning	<ul style="list-style-type: none"> Event opportunity assessment for understanding client's objectives and needs, feasibility assessment of an event, bidding, and developing a winning event proposal, are crucial to event planning. 	Online	US & below	Self paced learning	Swayam
BHC-013: Event Coordination and Control	<ul style="list-style-type: none"> Event Coordination – Managing the event process Stage Control Effective Control and Evaluation Leveraging technology 	Online	US & below	Self paced learning	Swayam
RTI – Record management	<ul style="list-style-type: none"> Record management under Right to information Act 	Online	US & below	4 days	ISTM
Public Procurement (Basic)	<ul style="list-style-type: none"> Principles of Public Procurement Application of General Financial Rules in Public Procurement of Goods Procurement of Goods from MSE Vendors and Startups Impact of “Atmanirbhar Bharat Abhiyan” Initiative, National Security and “Make in India” program on rules and Procedures of Public Procurement of Goods Procurement of Works with Government Fund Procurement of Consulting Services Procurement of Non- Consulting Services Contract Management Introduction to Procurement of Goods and Services from Government eMarket place (GeM) Introduction to e-procurement on the CPP Portal 	Offline	US & below	6 Days	NIFM
Public Procurement (Advanced)	<ul style="list-style-type: none"> Challenges to Public Procurement Anti-Competitive Behaviour of the Vendors: Cartelization, Bid Rigging, Collusive, Bidding Practical Situations International Best Practices in Public Procurement Competition Issues in Public Procurement Sustainable Procurement Engineering, Procurement and Construction Contracts and Design-Build Contracts Contract Price Adjustment Conditions, Price Adjustment Formulae eReverse Auction Arbitration and Conciliation Act 1996 & Other Legal Aspects Import of Goods 	Offline	Director & above	5 Days	NIFM

5.3.8.6. Coordination Section

Some of the key focus areas of the Coordination Section –

- Annual Report and related publications
- Coordination between Wings/ Divisions/Sections
- MP/VIP references

S. No.	Competency Assessment	Skills/Competency Related Intervention Suggested
1	Awareness of annual report publication	• Training on report writing and publications
2	Knowledge of VIP, MP references and related matters	• Training on handling VIP/ MP reference
3	Coordination and collection of materials within the section for Minister's speech	• -
4	Handling matters pertaining to Cabinet Meetings, Cabinet Committee Meetings and Secretary's meeting.	• Training on understanding of matters pertaining to Cabinet meetings
5	Coordination of work (With different Wings) with reference to implementation of decisions of the Cabinet	• Training on coordination with Wings/ Division

Thus, for the Coordination Section few suggested domain trainings and exposure visits are mentioned below.

Training Program	Modules Covered	Mode	Target Group	Duration	Knowledge Partner
DCE- 01: General Principles of Writing	<ul style="list-style-type: none"> • Covers training on professional writing 	Online	Up to US level	Self paced	Swayam
Public Grievance Handling & CPGRAM	<ul style="list-style-type: none"> • The course provides public grievance handling 	Online	Up to DS level	2 hrs	iGOT
Handling Parliamentary Matters	<ul style="list-style-type: none"> • Handling of parliamentary / cabinet matter • Induction Training - To be provided at the time of joining the Wing/ Division 	Online	Up to US level	2 days	ISTM

5.3.8.7. Parliament Section

Some of the key focus areas of the Parliament Section –

- Parliamentary Assurances
- Starred and Unstarred Questions
- Coordination with various Wings/ Divisions/ Sections

S. No.	Competency Assessment	Skills/Competency Related Intervention Suggested
1	Parliamentary procedures/ CCEA / Cabinet matters to address the Q&A	<ul style="list-style-type: none"> • Induction trainings for new joiners/ refresher trainings for officers in position to understand the parliamentary procedures, the addressal of questions and answers for parliamentary operations
2	Parliamentary bills, laws, and acts	<ul style="list-style-type: none"> • Trainings and workshops on parliamentary laws, bills, and new acts
3	Compilation and updating of Parliamentary Assurances	<ul style="list-style-type: none"> • Workshops / training sessions for updating the

S. No.	Competency Assessment	Skills/Competency Related Intervention Suggested
		parliamentary assurances
4	Issues Raised Under Rule 377 of the Lok Sabha, and Special Mentions in the Rajya Sabha	<ul style="list-style-type: none"> Modules / induction trainings on Issues raised under Rule 377 of Lok Sabha, Special Mentions in Rajya Sabha
5	Managing meetings of the Consultative Committee linked to the Ministry	<ul style="list-style-type: none"> Trainings for handling parliamentary matters

Thus, for the Parliament Section few suggested domain trainings are mentioned below.

Training Program	Modules Covered	Mode	Target Group	Duration	Knowledge Partner
Handling Parliamentary Matters	<ul style="list-style-type: none"> Topics includes day to day parliamentary practices for upskilling of officers 	Online	Up to US Level	2 Days	ISTM
Effective Cabinet Notes	<ul style="list-style-type: none"> Topics include cabinet noting/ drafting for parliamentary matters 	Online	Up to DS Level	1 Day	ISTM
List of Bills – Website –Ministry of Parliamentary Affairs	<ul style="list-style-type: none"> Awareness of bills related to parliamentary operations 	Reading Material	All Officials	NA	Ministry of Parliamentary Affairs
Assurance list – Website –Ministry of Parliamentary Affairs	<ul style="list-style-type: none"> Awareness of assurance list for parliamentary operations 	Reading Material	All Officials	NA	Ministry of Parliamentary Affairs
Guidelines on action of matter – Website –Ministry of Parliamentary Affairs	Knowledge of guidelines for matters of Action	Reading Material	All Officials	NA	Ministry of Parliamentary Affairs

5.3.8.8. RTI Section

Some of the key focus areas of the RTI Section –

- Implementation of Right to Information, 2005
- Processing of applications related to RTIs pertaining to MoRTH

S. No.	Competency Assessment	Skills/Competency Related Intervention Suggested
1	Awareness of CSMOP manual	<ul style="list-style-type: none"> Training/ induction material related to CSMOP manual
2	Awareness of RTI Act, 2005	<ul style="list-style-type: none"> Training on RTI Act and implementation
3	Furnishing of quarterly information to the Central Information Commission	

Thus, for the RTI Section few suggested domain trainings are mentioned below.

Training Program	Modules Covered	Mode	Target Group	Duration	Knowledge Partner
RTI – Record management	<ul style="list-style-type: none"> Record management under Right to information Act 	Online	US & below	4 days	ISTM
RTI Act – Appellate Authority	<ul style="list-style-type: none"> Right to Information – Appellate Authority 	Online	DS & above	1 day	ISTM

5.3.8.9. CR Section

Some of the key focus areas of the CR Section –

- Grievance redressal
- Citizens Charter

S. No.	Competency Assessment	Skills/Competency Related Intervention Suggested
1	Awareness of handling grievances	• Training on handling grievances
2	Awareness of managing citizen charter	• Training on preparation of Citizen's Charter
3	Handling approvals and sanctions of postal expenditure	• -
4	Managing receipts for various dispatch categories such as court cases etc.	• Training on handling court cases

Thus, for the CR Section few suggested domain trainings are mentioned below.

Training Program	Modules Covered	Mode	Target Group	Duration	Knowledge Partner
Public Grievance Handling & CPGRAM7.0	• The module provides the awareness on public grievance handling and CPGRAM 7.0 Portal	Online	All officials	1 hr	Online on iGOT
Citizens Charters - Handbook	• General Structure Guidelines, timelines	Reading material	All officials	Self paced	DARPG

5.3.8.10. O&M Section

Some of the key focus areas of the O&M Section –

- Records management
- Matters related to Office procedures
- Public Records Act 1993

S. No.	Competency Assessment	Skills/Competency Related Intervention Suggested
1	Knowledge of inspection of sections/ wings	• Training of inspection of sections/ wings
2	Awareness of Record Management under the Public Records Act 1993	• Training of Public Records Act 1993 and Rules 1997
3	Knowledge of Public Records Rules, 1997	
4	Preparation of compiled report on review of Acts/Rules	• Training of data compilation

Thus, for the O&M Section few suggested domain trainings are mentioned below.

Training Program	Modules Covered	Mode	Target Group	Duration	Knowledge Partner
Advanced course on Record Management	• Record Management under the Public Records Act 1993	Online	Up to DS level	2 days	ISTM
Data Analytics	• Data collection, compiling, and	Offline	Up to US	3 days	ISTM

using MS-Excel	circulating time series data		level		
Public Records Act 1993 And Rules 1997	<ul style="list-style-type: none"> Public Records Act 1993 And Rules 1997 	Online	All Officials	Self-paced	-

5.3.8.11. Cash Section

Some of the key focus areas of the Cash Section is maintain accounts and cash.

S. No.	Competency Assessment	Skills/Competency Related Intervention Suggested
1	Financial management	<ul style="list-style-type: none"> Training on financial management
2	Accounting skills	<ul style="list-style-type: none"> Training on accounting skills
3	Data analytics	<ul style="list-style-type: none"> Data analytics and processing trainings

Thus, for the Cash Section few suggested domain trainings are mentioned below.

Training Program	Modules Covered	Mode	Target Group	Duration	Knowledge Partner
Data Analytics using MS-Excel	<ul style="list-style-type: none"> Data collection, compiling, circulating time series data and analysis 	Online	Up to US level	4 hours 30 mins	iGOT
Cash & Accounts	<ul style="list-style-type: none"> Training on managing cash and accounts 	Offline	SO, ASO	9 weeks	ISTM

5.3.8.12. Hindi Section

Some of the key focus areas of the Hindi Section –

- Translation of documents to Hindi
- Compliance with Official Languages Act

S. No.	Competency Assessment	Skills/Competency Related Intervention Suggested
1	Document Translation	<ul style="list-style-type: none"> Training on document translation and language proficiency
2	Language proficiency	
3	Understanding of technical and legal terminologies	
4	Proof reading	<ul style="list-style-type: none"> Training on proof reading and quality assurance of officials documents
5	Quality assurance	

Thus, for the Hindi Section few suggested domain trainings are mentioned below.

Training Program	Modules Covered	Mode	Target Group	Duration	Knowledge Partner
Induction Translation Training	<ul style="list-style-type: none"> For Hindi translation Induction Training - To be provided at the time of joining the Wing/ Division 	Offline	AD & below	6 weeks	Central Translation Bureau

5.3.8.13. Vigilance Section

Some of the key focus areas of the Vigilance Section –

- Receipt and processing of complaints of vigilance
- Implementation of Anti-corruption measures

S. No.	Competency Assessment	Skills/Competency Related Intervention Suggested
1	CVC guidelines and disciplinary proceedings	<ul style="list-style-type: none"> • Central Vigilance Commission Guidelines and disciplinary proceedings official documents to be studied by officers for awareness of guidelines
2	Comptroller and Auditor General Manual (CAG)	<ul style="list-style-type: none"> • Training and awareness of CAG manuals and guidelines
3	Vigilance rules/ regulations and guidelines	<ul style="list-style-type: none"> • Awareness of vigilance rules and regulations for new joiners and officers in position

Thus, for the Vigilance Section few suggested domain trainings are mentioned below.

Training Program	Modules Covered	Mode	Target Group	Duration	Knowledge Partner
Conduct of Inquiry in disciplinary matters	<ul style="list-style-type: none"> • The video module provides the steps of conducting inquiry in disciplinary/ vigilance cases 	Online	Up to DS level	42 hrs	iGOT
Vigilance Clearance	<ul style="list-style-type: none"> • The course provides issue of grant of vigilance clearance for different purposes. 	Online	Up to US Level	12 hrs	iGOT
Inquiry/CVC Matters – CVC Website	<ul style="list-style-type: none"> • The document provides the details related to enquiry and processes 	Online	All officials	Self paced	Reading Material
CVC Act – CVC Website	<ul style="list-style-type: none"> • The document provides the content of the Act 	Online	All officials	Self paced	Reading Material
CAG Manual – Website	The manual provides the CAG guidelines	Online	All officials	Self paced	Reading Material

5.3.9. Transport research Wing (TRW)

Some of the key focus areas of the TRW –

- Data visualization (graphical representation of data) with new tools and techniques for better data interpretation
- Data collection, compiling, and circulating time series data.
- Statistics, economics, and data modelling
- Laws & regulations / policy matters related to roads, transport sector and relevant amendments.

S. No.	Competency Assessment	Skills/Competency Related Intervention Suggested
1	Data visualization (graphical representation of data) with new tools and techniques for better data interpretation	<ul style="list-style-type: none"> • Trainings on data visualization techniques as per new industry requirements • Graphical analysis and providing insights
2	Data collection, compiling, and circulating time series data	<ul style="list-style-type: none"> • Training modules on data collection, cleaning and using it for further analysis, model making etc.
3	Laws & regulations / policy matters related to roads, transport sector and relevant amendments	<ul style="list-style-type: none"> • Awareness of regulations, policies and other important matters for all employees

S. No.	Competency Assessment	Skills/Competency Related Intervention Suggested
4	Managing annual manual of the division - namely Basics Road Statistics, Road Transport Yearbook, Road Accidents in India, and Review of Performance of State Road Transport Undertakings	<ul style="list-style-type: none"> Management trainings for the annual publications of the Wing

Thus, for the TRW few suggested domain trainings and exposure visits are mentioned below.

Training Program	Modules Covered	Mode	Target Group	Duration	Knowledge Partner
Data Driven Decision Making	<ul style="list-style-type: none"> Includes trainings for- bringing insights based on data 	Online	All Officials	4h 30 mins	iGOT
Data Analytics using MS-Excel	<ul style="list-style-type: none"> Trainings for officers to upskill in MS - Excel. It covers basic operations to increase the functional efficiency of the employees 	Offline	DD & AD	3 days	ISTM
Statistical Tools and Techniques	<ul style="list-style-type: none"> Basic statistics for day-to-day tasks such as descriptive statistics for data analysis 	Online	Up to JD level	2 Days	ISTM
Formulation of public policy	<ul style="list-style-type: none"> Basic training program for formulation of public policy 	Online	All Officials	1hr	iGOT
DCE- 01: General Principles of Writing	<ul style="list-style-type: none"> Covers training on professional writing 	Online	Up to JD level	16 weeks	Swayam

5.3.10. Indian Academy of Highway Engineers (IAHE)

Some of the key focus areas of the IAHE –

- Training needs assessment and identification of training requirements.
- Capacity building of individual and organization
- Preparation of training calendars, training, plan, co-ordination with trainers and experts
- Preparation of curriculum for various trainings & certifications
- Promotion of training activities and registration of candidates for training programmes
- International cooperation on knowledge sharing and training.
- Event management and program management
- Training tools, techniques for classroom and online training

S. No.	Competency Assessment	Skills/Competency Related Intervention Suggested
1	Training needs assessment and identification of training requirements	<ul style="list-style-type: none"> Courses on Training need analysis to design a specific curriculum
2	Capacity building of individual and organization	<ul style="list-style-type: none"> Courses and regular workshops on mentorship, training needs analysis
3	Preparation of training calendars, training, plan, co-ordination with trainers and experts	<ul style="list-style-type: none"> Courses and regular workshops on mentorship, training needs analysis
4	Preparation of curriculum for various trainings & certifications	<ul style="list-style-type: none"> Courses on Training need analysis to design a specific curriculum
5	Promotion of training activities and registration of candidates for training programs	<ul style="list-style-type: none"> Courses on event management, training needs assessments
6	International cooperation on knowledge sharing and training	<ul style="list-style-type: none"> Trainings on international forums for knowledge sharing
7	Event management and program management	<ul style="list-style-type: none"> Courses on event management, training needs assessments

S. No.	Competency Assessment	Skills/Competency Related Intervention Suggested
8	Training tools, techniques for classroom and online training	<ul style="list-style-type: none"> Courses on Training need analysis to design a specific curriculum, technical upgradation workshops

Thus, for the IAHE few suggested domain trainings are mentioned below.

Training Program	Modules Covered	Mode	Target Group	Duration	Knowledge Partner
Training Need Analysis	<ul style="list-style-type: none"> Training needs assessment and identification of training requirements. Capacity building of individual and organization 	Online	JD & DD	Self paced learning	ISTM
Workshop on Mentoring	<ul style="list-style-type: none"> Training on mentorship, leadership values 	Online	JD & above	Self paced learning	ISTM
BHC-012: Event Planning	<ul style="list-style-type: none"> Event opportunity assessment for understanding client's objectives and needs, feasibility assessment of an event, bidding, and developing a winning event proposal, are crucial to event planning. 	Online	DD	Self paced learning	Swayam
BHC-013: Event Coordination and Control	<ul style="list-style-type: none"> Event Coordination – Managing the event process Stage Control Effective Control and Evaluation Leveraging technology 	Online	Up to JD Level	Self paced learning	Swayam
Management of Training	<ul style="list-style-type: none"> Trainings modules on training managements and 	Online	All Officials	Self paced learning	ISTM
Strategy for building and sustaining competitive advantage	<ul style="list-style-type: none"> Modules on strategy building Learning competitive advantage 	Offline	AD & above	1 day	ACSI

6. Proposed Training Calendar

Table 9: Training Calendar - MoRTH

Competency Category	Competency Addressed	Name of Course / Training / Module/Intervention	Type of Intervention	Duration (Hours)	Mode	Training Institute/ Partner Organization	Target Group of Participants/ Designation/ Division			Level of Course	Timeline
							Designation	Division	# of Participants		
Functional	Central Portals (e-office, NIC Portal, Grievance Portal, VIP Portal, Bhoomirashi Portal and any other relevant portal)	Basics of e-Governance & Digital India	Training	1 hr	Online	iGOT	Up to DS Level	All Wings & Divisions	130-140	L1	Q4 FY2024
		Government e-Marketplace	Training	1 hr 9 mins	Online	iGOT	Up to DS Level	All Wings & Divisions	90-100	L2	Q4 FY2024
Functional	MS Office (Word, PowerPoint, Excel)	Excel Advanced	Training	3h 49 mins	Online	iGOT	Up to US Level	All Wings & Divisions	90-100	L3	Q1 FY2025
		Advance PowerPoint	Training	2 hrs 28 mins	Online	iGOT	Up to US Level	All Wings & Divisions	90-100	L3	Q1 FY2025
		MS Word	Training	3 days	Physical	ISTM	Up to US Level	All Wings & Divisions	90-100	L2	Q1 FY2025
Functional	Government documentation (noting, drafting, cabinet notes, parliamentary answers, reports, Memorandum of Understanding etc.), reporting for parliamentary procedures, questions, and RTI queries	Noting & drafting	Training	2 hrs	Online	iGOT	Up to US Level	All Wings & Divisions	90-100	L2	Q1 FY2025
		Preparation of Cabinet Notes	Training	5 hrs 10 mins	Online	ISTM	Up to Director Level	All Wings & Divisions	90-100	L3	Q1 FY2025
Functional	Financial procedures/ GFR/ Bill clearances/ PFMS	GFR - Rule book	Reading material	Self-paced	Online	GFR Rules - Website	Up to US Level	All Wings & Divisions	90-100	L2	Q2 FY 2025
		Financial Procedures - Cash & Accounts	Training	Self-paced	Online	ISTM	Up to US Level	All Wings & Divisions	90-100	L2	Q1 FY2025
		Public Financial Management System (PFMS) Training - Every Month	Training	Self-paced	Online	DoE, Ministry of Finance	Nomination Basis	All Wings & Divisions	Nomination Basis	L3	Q2 FY 2025
Functional	GRM (Grievance Redressal Mechanism), CPGRAMs and INGRAMs Portals	Public Grievance Handling & CPGRAM7.0	Training	1 hr	Online	iGOT	Up to Director Level	All Wings & Divisions	130-140	L2	Q1 FY2025

Competency Category	Competency Addressed	Name of Course / Training / Module/Intervention	Type of Intervention	Duration (Hours)	Mode	Training Institute/ Partner Organization	Target Group of Participants/ Designation/ Division			Level of Course	Timeline
							Designation	Division	# of Participants		
Functional	Government procurement protocols, processes, and tools (RFP, Tender Evaluation, Tender Award, Government e Marketplace - GeM) etc.)	Public Procurement Framework for government processes	Training	1 hr	Online	iGOT	Up to US Level	All Wings & Divisions	90-100	L2	Q1 FY2025
Functional	Judicial Pronouncement and Restrictions, Audit Paras and Court Cases	Administrative Law	Training	1 hr 3 mins	Online	iGOT	All Officials	All Wings & Divisions	130-140	L2	Q1 FY2025
Behavioural	Gender sensitization and anti-sexual harassment	Prevention of Sexual Harassment of Women at Workplace	Training	1 hr 51 mins	Online	iGOT	All Officials	All Wings & Divisions	130-140	L1	Q4 FY2024
Behavioural	Adaptation to new skills and methodologies	Cyber Security and Strategy	Training	1 Hr	Online	iGOT	All Officials	All Wings & Divisions	130-140	L1	Q4 FY2024
Domain	Highway development including engineering, cost estimation, construction, and monitoring Maintenance of National Highways including planning, engineering, implementation, and monitoring	Design, construction, Maintenance & Operations of Expressway	Training	5 days	Physical	IAHE	Up to SE Level	Road Wing (Regional Zone, Planning, S&R, Monitoring & EAP)	35	L3	Q2 FY 2025
		Preparation of DPR for Highways Project	Training	6 days	Physical	IAHE	Up to SE Level	Road Wing (Regional Zone, Planning, S&R, Monitoring & EAP)	35	L3	Q1 FY2025
Domain	Quality control and assurance	Construction of quality controls	Training	5 days	Physical	IAHE	Up to SE Level	Road Wing (Regional Zone)	18	L2	Q4 FY2024
Domain	Road safety engineering and audit	Road safety engineering & Auditing	Training	5 days	Offline	IAHE	Up to SE Level	Road Wing (Regional Zone)	18	L2	Q4 FY2024
Domain	Project Management, controlling and reporting including various project management tools and techniques.	Project Management	Training	1 hr 15 mins	Online	iGOT	Up to EE Level	Road Wing (Regional Zone & EAP)	26	L2	Q1 FY2025

Competency Category	Competency Addressed	Name of Course / Training / Module/Intervention	Type of Intervention	Duration (Hours)	Mode	Training Institute/ Partner Organization	Target Group of Participants/ Designation/ Division			Level of Course	Timeline
							Designation	Division	# of Participants		
Domain	Contract management and administration	Contract Management, Dispute Resolution and Arbitration in Highway Projects	Training	5 days	Offline	IAHE Campus	SE & above	Road Wing (Regional Zone, Planning, S&R, Monitoring & EAP)	45	L3	Q2 FY 2025
Domain	Latest practices and technologies related to design, construction, maintenance & materials used in highways	New Technology Vision 2022	Training	1 hr	Online	iGOT	Up to SE level	Road Wing (Regional Zone, Planning, S&R, Monitoring & EAP)	45	L2	Q4 FY2024
Domain	Bridge and Tunnel engineering	DPR for bridges	Training	6 days	Offline	IAHE	Up to SE level	Road Wing (Regional Zone)	26	L4	Q3 FY2025
Domain	Motor Vehicles Act, 1988	Motor Vehicle Act, 1988 – Guidelines & Related amendments	Reading material	Self Paced	Online	MoRTH Website	Up to DS Level	MVL & Road Safety Division	17	L1	Q4 FY2024
		Course on Motor Vehicles Act 1988	Training	26 hours	Online	Unacademy	Up to US level	MVL & Road Safety Division	17	L1	Q4 FY2024
Domain	Assessment of performance of Road Transport schemes and prepare improvement	Monitoring & Evaluation of Government Schemes	Training	1 day	Online	ISTM	Up to DS Level	Transport Division	8	L3	Q2 FY 2025
Domain	Legislative drafting	Training Program on Legislative Drafting	Training	25 days	Hybrid	Parliamentary Research and Training Institute for Democracies	Up to DS Level	MVL & Automotive Division	9	L3	Q1 FY2025
Domain	Automotive Testing standards and safety	Automotive Testing & Certification	Training	Self Paced	Physical	ARAI	Scientist	MVL & Automotive Division	3	L3	Q2 FY 2025
Domain	e Emission guidelines, initiatives and policies related to emission reduction including alternate fuels etc.	Real driving emission	Training	3 days	Physical	ARAI	CE	MVL & Automotive Division	3	L3	Q3 FY2025
Domain	Automotive Testing standards and safety	Bharat New Car Assessment Program (Bharat NCAP)	Training	1 hour	Online	IAHE	CE & Scientist	MVL & Automotive Division	3	L2	Q3 FY2025

Competency Category	Competency Addressed	Name of Course / Training / Module/Intervention	Type of Intervention	Duration (Hours)	Mode	Training Institute/ Partner Organization	Target Group of Participants/ Designation/ Division			Level of Course	Timeline
							Designation	Division	# of Participants		
Domain	Global practices and innovation in automotive regulations, safety norms, testing norms etc.	Knowledge and Experience sharing Program (For international Cooperation in Korea)	Training	1 Week	Offline	Korean Road Association	Director & above	Road Transport Wing	2	L2	Q4 FY2024
Domain	Data analysis and process	Data Driven Decision Making	Training	4 hrs 30 mins	Online	iGOT	Up to DS level	Road Safety Division & Transport Division	14	L2	Q1 FY2025
Domain	Road Safety Audit	Road safety engineering & Audit	Training	5 days	Offline	IAHE	AEE	Road Safety Division	1	L2	Q2 FY 2025
Domain	Understanding of all service matters of officers/officials of MoRTH	Office Procedures	Training	1 hr 15 mins	Online	iGOT	DS & below	Est. Section	19	L2	Q4 FY2024
Domain	Understanding of all service matters of officers/officials of MoRTH	Fundamental Rules & Supplementary Rules	Training	Self-paced	Online	ISTM	US & below	Est. Section	18	L2	Q1 FY2025
Domain	Knowledge of maintenance of APAR reports for the officials	Development of Attitude Knowledge Skill for Holistic Transformation in Administration (DAKSHTA)	Training	15 Days	Hybrid	iGOT and ISTM	US & below	EIB Section	5	L2	Q1 FY2025
Domain	Awareness of Recruitment rules for the Central engineering Service (Roads) Group "A" and General Central Service Group "B" "C" and "D" posts.	Service Rules of CES (Roads)	Reading material	Self Paced	Online	MoRTH	Up to DS Level	EII Section	8	L2	Q2 FY 2025
Domain	LTC/TA Rules/ etc.	LTC Rules	Reading Material	Self Paced	Online	DoPT	Up to DS Level	EII Section	8	L2	Q4 FY2024
Domain	Constitution, members, chairman, appointment etc.	NHAI Act, 1988	Reading Material	Self Paced	Online	MoRTH	Up to DS Level	EIIB	5	L2	Q4 FY2024
Domain	Budget, Accounts, Audit, Investment of Funds, and Powers to enter premises	NHAI Rules 1990	Reading Material	Self Paced	Online	MoRTH	Up to DS Level	EIIB	5	L2	Q4 FY2024
Domain	Guidelines for officer trainings	DoPT guidelines for officer trainings	Reading Material	Self Paced	Online	DoPT	Up to DS Level	EIIB	5	L2	Q4 FY2024

Competency Category	Competency Addressed	Name of Course / Training / Module/Intervention	Type of Intervention	Duration (Hours)	Mode	Training Institute/ Partner Organization	Target Group of Participants/ Designation/ Division			Level of Course	Timeline
							Designation	Division	# of Participants		
Domain	Event Management	BHC-012: Event Planning	Training	Self Paced	Online	Swayam	US & below	General Section	6	L2	Q1 FY2025
Domain		BHC-013: Event Coordination and Control	Training	Self Paced	Online	Swayam	US & below	General Section	6	L2	Q2 FY 2025
Domain	Record Management	RTI - Record management	Training	4 days	Online	ISTM	US & below	General Section	6	L2	Q1 FY2025
Domain	Procurement of goods & services	Public Procurement (Basic)	Training	6 Days	Online	NIFM	US & below	General Section	6	L2	Q1 FY2025
Domain		Public Procurement (Advanced)	Training	5 Days	Online	NIFM	Director & above	General Section	2	L2	Q2 FY 2025
Domain	Coordination with different departments	DCE- 01: General Principles of Writing	Training	Self paced	Online	Swayam	Up to US level	Coordination Section	6	L2	Q1 FY2025
Domain	Handling matters pertaining to Cabinet Meetings, Cabinet Committee Meetings and Secretary's meeting.	Handling Parliamentary Matters	Training	2 days	Online	ISTM	Up to US level	Coordination Section	6	L2	Q1 FY2025
Domain	Awareness of RTI Act, 2005	RTI - Record management	Training	4 days	Online	ISTM	Up to US level	RTI Section	3	L2	Q1 FY2025
Domain		RTI Act - Appellate Authority	Training	1 day	Online	ISTM	Up to DS level	RTI Section	2	L2	Q2 FY 2025
Domain	Record Management under the Public Records Act 1993	Advanced course on Record Management	Training	2 days	Online	ISTM	Up to DS level	O&M Section	4	L3	Q1 FY2025
Domain	Data collection, compiling, and circulating time series data	Data Analytics using MS-Excel	Training	3 days	Offline	ISTM	Up to US level	O&M Section	3	L3	Q1 FY2025
Domain	Public Records Act 1993 And Rules 1997	Public Records Act 1993 And Rules 1997	Training	Self-paced	Online	-	Up to US level	O&M Section	5	L2	Q2 FY 2025
Domain	Managing cash and accounts	Cash & Accounts	Training	9 weeks	Offline	ISTM	SO, ASO	Cash Section	5	L2	Q1 FY2025

Competency Category	Competency Addressed	Name of Course / Training / Module/Intervention	Type of Intervention	Duration (Hours)	Mode	Training Institute/ Partner Organization	Target Group of Participants/ Designation/ Division			Level of Course	Timeline
							Designation	Division	# of Participants		
Domain	Document Translation	Induction Translation Training	Training	6 Weeks	Offline	Central Translation Bureau	AD & below	Hindi Section	2	L2	Q3 FY2025
Domain	CVC guidelines and disciplinary proceedings	Conduct of Inquiry in disciplinary matters	Training	42 hrs	Online	iGOT	Up to DS level	Vigilance Section	4	L2	Q2 FY 2025
Domain	CVC guidelines and disciplinary proceedings	Vigilance Clearance	Training	12 hrs	Online	iGOT	Up to US Level	Vigilance Section	3	L2	Q2 FY 2025
Domain	Highway engineering, highway maintenance, quality etc.	Preparation of DPR for Highways Project	Training	6 days	Offline	IAHE	EE, AEE	Highway Division	3	L2	Q2 FY 2025
Domain	Processing of draft note for Cabinet Committee on Economic Affairs (CCEA)	Effective Cabinet Notes – up to Group A officers	Training	1 day	Online	ISTM	All Officials	Highway Division	9	L1	Q1 FY2025
Domain	Latest practices and technologies related to design, construction, maintenance & materials used in highways	New Technology Vision 2022	Training	1 hr	Online	iGOT	All Officials	Highway Division	9	L2	Q1 FY2025
Domain	Highway engineering, highway maintenance, quality etc.	Highway and Structure Construction and Maintenance	Exposure Visit	3 days	Offline	Federal Highway Administration	DS & above	Highway Division	2		Q1 FY2025
Domain	Financial Planning	Financial Accounting and Analysis	Training	6 Weeks	Online	Swayam Portal	Up to DS Level	Finance Wing	6	L2	Q1 FY2025
Domain	Budgeting	Budgeting, accounting, and financial management in government sector	Training	4 weeks	Online	NIFM	Up to DS Level	Finance Wing	6	L2	Q1 FY2025

Competency Category	Competency Addressed	Name of Course / Training / Module/Intervention	Type of Intervention	Duration (Hours)	Mode	Training Institute/ Partner Organization	Target Group of Participants/ Designation/ Division			Level of Course	Timeline
							Designation	Division	# of Participants		
Domain	Manage BE/RE proposals from different administrative units	Workshop on Preparation of Expenditure Finance Committee/ Standing Finance Committee -ISTM	Training	2 days	Online	ISTM	DS and Above	Finance Wing	3	L3	Q1 FY2025
Domain	Various portals such as PFMS etc.	Orientation Training Programme on PFMS	Training	2 days	Online	ISTM	US, SO, ASO	Finance Wing	7	L2	Q4 FY2024
Domain	Data visualization (graphical representation of data) with new tools and techniques for better data interpretation	Data Driven Decision Making	Training	4 hrs 30 mins	Online	iGOT	All Officials	Transport Research Wing	10	L3	Q2 FY 2025
Domain	Data collection, compiling, and circulating time series data	Data Analytics using MS-Excel	Training	3 days	Physical	ISTM	DD & AD	Transport Research Wing	2	L3	Q4 FY2024
Domain	Statistics, economics, and data modelling	Statistical Tools and Techniques – ISTM	Training	2 days	Online	ISTM	Up to JD level	Transport Research Wing	3	L4	Q4 FY2024
Domain	Managing annual manual of the division – namely Basics Road Statistics, Road Transport Yearbook, Road Accidents in India, and Review of Performance of State Road Transport Undertaking	DCE- 01: General Principles of Writing	Training	16 Weeks	Online	Swayam Portal	Up to JD level	Transport Research Wing	3	L4	Q1 FY2025
Domain	Diplomacy and negotiation skills	Bilateral Policy Coordination Training	Training	4 weeks	Online	Online	Up to Director level	IC Division	2	L3	Q3 FY2025
Domain	Policy development and analysis	Policy Making Programme	Training	12 weeks	Online	ISB	US and below	IC Division	3	L2	Q3 FY2025
Domain	Diplomacy and negotiation skills	Training Course ON Negotiation Skills AND Techniques	Training	2 days	Online	UNITAR (United Nations Institute for Training and Research)	Director & Above	IC Division	2	L2	Q3 FY2025
Domain	Commercial Operations of MMLPs	Supply Chain & Demand Analytics	Training	Self Paced	Online	NITIE / IIM Mumbai	Up to Director Level	Logistics Section	2	L3	Q2 FY 2025

Competency Category	Competency Addressed	Name of Course / Training / Module/Intervention	Type of Intervention	Duration (Hours)	Mode	Training Institute/ Partner Organization	Target Group of Participants/ Designation/ Division			Level of Course	Timeline
							Designation	Division	# of Participants		
Domain	National Logistics Policy etc.	PM Gati Shakti Training	Training	35 hrs	Online	iGOT	Up to US Level	Logistics Section	7	L1	Q1 FY2025
Domain	Freight Logistics and Transportation including various business models (Hub & Spoke, Point to Point), multimodal operations, etc.	Freight Business	Training	1 hr 7 mins	Online	iGOT	All Officials	Logistics Section	7	L3	Q2 FY 2025
Domain	Ropeway engineering, technologies, and operations	Ropeway Trainings	Training	Hybrid Mode, the duration may vary as per the selected modules of the course	Offline	Ropeway Training Centre, Dornbirn	Director & above	Logistics Section	2	L3	Q3 FY2025
Domain	Training needs assessment and identification of training requirements	Training Need Analysis	Training	3 days	Online	ISTM	JD & DD	IAHE	6	L4	Q4 FY2024
Domain	Capacity building of individual and organization	Workshop on Mentoring	Training	3 days	Online	ISTM	JD & above	IAHE	3	L4	Q4 FY2024
Domain	Event management and program management	BHC-012: Event Planning	Training	Self Paced	Online	Swayam	DD	IAHE	5		Q1 FY2025
		BHC-013: Event Coordination and Control	Training	Self Paced	Online	Swayam	Up to JD Level	IAHE	6	L3	Q2 FY 2025
Domain	Training tools, techniques for classroom and online training	Management of Training	Training	1 week	Online	ISTM	All Officials	IAHE	8	L2	Q1 FY2025
Domain	Policy / Rule drafting on the domain	Formulation of public policy	Training	1 hr 15 mins	Online	iGOT	Up to SE Level	Toll Division	4	L2	Q3 FY2025
Domain	Implementation of Electronic Toll Collection System	Intelligent Transport System (ITS) and Electronic Toll Collection (ETC)	Training	3 days	Physical	IAHE	Up to SE level	Toll Division	4	L2	Q2 FY 2025
Domain	Parliamentary bills, laws, and acts	List of Bills	Training	Self Paced	Online	List of Bills – Website – Ministry of Parliamentary	Up to US Level	Parliament Section	8	L1	Q1 FY2025

Competency Category	Competency Addressed	Name of Course / Training / Module/Intervention	Type of Intervention	Duration (Hours)	Mode	Training Institute/ Partner Organization	Target Group of Participants/ Designation/ Division			Level of Course	Timeline
							Designation	Division	# of Participants		
						Affairs					
Domain	Compilation and updating of Parliamentary Assurances	Assurance list	Reading material	Self Paced	Online	Assurance list - Website - Ministry of Parliamentary Affairs	Up to US Level	Parliament Section	8	L1	Q1 FY2025

The Ministry could consider setting a minimum number of trainings to be completed by senior office of level JS and above, to 2 online training programs and one training program to be attended in person, physical presence. Further the Ministry may consider the nomination of approx. 5 participant for the relevant programs and updated and revised by IAHE from time to time. In addition, the periodicity of refresher trainings may be decided by the Ministry depending upon the requirement and complexity of the course.

Average training hour for each level for the Wings/ Divisions/ Sections is given below:

Wing/ Division	Average Online (hours) / Physical Training (days)						
	AS/ ADG/ DDG/ EA	JS/ CE	Director/SE	DS/ EE	US/ AEE	SO	ASO
Regional Zone	4 hrs / 5 days	4 hrs / 5 days	10 hrs / 15 days	10 hrs / 15 days	10 hrs / 15 days	-	-
Planning Section	4 hrs / 5 days	4 hrs / 5 days	10 hrs / 8 days	10 hrs / 8 days	10 hrs / 8 days	-	-
S&R Section	4 hrs / 5 days	4 hrs / 5 days	10 hrs / 8 days	10 hrs / 8 days	10 hrs / 8 days	-	-
Monitoring Section	4 hrs / 5 days	-	-	10 hrs / 8 days	10 hrs / 8 days	-	-
EAP Zone	-	4 hrs / 5 days	10 hrs / 10 days	10 hrs / 10 days	-	-	-
MVL & Automotive Division	4 hrs/ -	4 hrs/ 3 days	-	45 hrs / 7 days	45 hrs / 11 days	50 hrs / 16 days	50 hrs / 16 days
Road Safety Division	4 hrs/ -	-	-	24 hrs / 5 days	40 hrs / 8 days	40 hrs / 8 days	40 hrs / 8 days
Transport Division	4 hrs/ 7 days	-	-	24 hrs / 5 days	40 hrs / 8 days	40 hrs / 8 days	40 hrs / 8 days
Highways Division	5 hrs/ 5 days	-	-	25 hrs/ 7 days	35 hrs/ 10 days	35 hrs/ 8 days	35 hrs/ 8 days
LA Division	4 hrs/ -	-	-	25 hrs/ 7 days	35 hrs/ 10 days	35 hrs/ 8 days	35 hrs/ 8 days
Logistics Section	5 hrs/ 5 days	-	7 hrs/ 7 days	45 hrs / 5 days	35 hrs/ 10 days	-	35 hrs/ 10 days

Wing/ Division	Average Online (hours) / Physical Training (days)						
	AS/ ADG/ DDG/ EA	JS/ CE	Director/SE	DS/ EE	US/ AEE	SO	ASO
Toll Division	4 hrs/ -	-	9 hrs/ 3 days	-	9 hrs/ 6 days	-	9 hrs/ 6 days
IC Division	4 hrs/ -	-	40 hrs/ -	-	45 hrs/ 3 days	-	50 hrs/ 3 days
Finance Wing	12 hrs/ -	-	26 hrs/ -	45 hrs/ 3 days	45 hrs/ 3 days	50 hrs/ 3 days	50 hrs/ 3 days
Establishment Section (EI, EIB, EII and EIIIB)	-	4 hrs / 5 days	35 hrs/ 8 days	45 hrs/ 8 days	40 hrs/ 5 days	50 hrs/ 8 days	50 hrs/ 8 days
General Section	-	4 hrs / 5 days	35 hrs/ 8 days	45 hrs/ 8 days	40 hrs/ 5 days	50 hrs/ 8 days	50 hrs/ 8 days
Coordination Section	-	4 hrs / 5 days	35 hrs/ 8 days	45 hrs/ 8 days	40 hrs/ 5 days	50 hrs/ 8 days	50 hrs/ 8 days
Parliament Section	-	4 hrs / 5 days	35 hrs/ 8 days	45 hrs/ 8 days	40 hrs/ 5 days	50 hrs/ 8 days	50 hrs/ 8 days
RTI Section	-	4 hrs / 5 days	35 hrs/ 8 days	45 hrs/ 8 days	40 hrs/ 5 days	50 hrs/ 8 days	50 hrs/ 8 days
CR Section	-	4 hrs / 5 days	35 hrs/ 8 days	45 hrs/ 8 days	40 hrs/ 5 days	50 hrs/ 8 days	50 hrs/ 8 days
O&M Section	-	4 hrs / 5 days	35 hrs/ 8 days	45 hrs/ 8 days	40 hrs/ 5 days	50 hrs/ 8 days	50 hrs/ 8 days
Cash Section	-	4 hrs / 5 days	35 hrs/ 8 days	45 hrs/ 8 days	40 hrs/ 5 days	50 hrs/ 8 days	50 hrs/ 8 days
Hindi Section	-	4 hrs / 5 days	35 hrs/ 8 days	45 hrs/ 8 days	40 hrs/ 5 days	50 hrs/ 8 days	50 hrs/ 8 days
Vigilance Section	-	4 hrs / 5 days	35 hrs/ 8 days	45 hrs/ 8 days	40 hrs/ 5 days	50 hrs/ 8 days	50 hrs/ 8 days
TRW	8 hrs/ 5 days	-	50 hrs/ 7 days	50 hrs/ 7 days	35 hrs/ 7 days	-	-
IAHE		4 hrs/ 3 days	50 hrs/ 3 days	50 hrs/ 3 days	50 hrs/ 3 days	-	-

7. Monitoring and Evaluation Plan and Implementation Framework

7.1. Framework for Monitoring and Evaluation Plan

The M&E plan considers various parameters that will be crucial to consider in evaluating the impact of proposed capacity building initiatives as summarized below:

Key Performance Indicators (KPIs)	Relevant KPIs such as number of staff members to be trained, assessments etc. helps achieve focus on the aspects of interventions which could be measured and evaluated
Data Collection Methods & Tools	Outlining methods and tools used to collect relevant data and observations around knowledge improvement, staff feedback and experience and application
Data Analysis	Analysing data to reach insights around successful training methods, program effectiveness and impact
Reporting and Feedback Mechanism	Setting up a mechanism that promotes accountability in the implementation process

KPIs

Defining key performance indicators (KPIs) is crucial to the monitoring and evaluation of the impact of capacity building interventions on department officials.

Assessment through these KPIs will help in identifying areas of strength and areas that require improvement and also in making informed decisions around the adjustments required in the CBP, resource allocation and the overall efficiency in implementation. It would involve taking a review of number of courses taken up and scale of participation, as well as feedback and applicability of the courses.

The proposed KPIs are mentioned in the table below:

Number of department officials trained: The total number of officials in all divisions who have participated in the proposed training and non-training interventions identified as part of the ACBP

Participant satisfaction: Feedback from participants regarding their satisfaction with the training sessions, including the relevance of the content, quality of delivery, and overall experience

Knowledge improvement: Pre and post-assessment scores to measure the increase in knowledge and skills among the department officials participating in the training

Performance enhancement: Evaluation of performance indicators, such as improved productivity, effectiveness, or efficiency, attributable to the capacity building initiatives

Organizational impact: Identifying the broader impact of the capacity building initiatives on the overall functioning and success of the Department, such as improved service delivery, increased participation in sector related programs, or enhanced public perception

Knowledge sharing and transfer: Assessing the extent to which officials are sharing their newly acquired knowledge and skills with colleagues, contributing to a culture of continuous learning and knowledge sharing within the department

Data Collection

Data collection methods and tools provide objective and reliable information that serves as evidence for decision-making processes regarding the implementation of the ACBP and help in performance measurement of performance indicators related to the training and non-training interventions identified.

- For the Ministry, the method to collect data for monitoring and evaluation purposes could include surveys, focus group discussions, and analysis of findings.
- Both qualitative and quantitative data collection methods will be essential to capture a comprehensive understanding of impact of interventions.

- Tools to be used for the department could be tailored for each division basis their role and mandate and include survey questionnaires, interview guides, observation checklists, or feedback forms.
- Pre- and post-training assessment could be conducted to evaluate knowledge improvement along with circulation of participant feedback forms to capture satisfaction and feedback on training session.
- It is to be ensured that the tools capture relevant information and can be easily administered to participants, trainers, and other stakeholders.

Data Analysis

Data analysis will help ensure that collected data is properly interpreted and to generate findings from collected data. It will help set the course of future initiatives around capacity building in the various Divisions and the Department as a whole. The findings from monitoring and evaluation could be utilized to make necessary adjustments and improvements to the proposed capacity building plan. This can involve refining training programs, addressing identified gaps, reallocating resources, or implementing additional support mechanisms. Key points to consider include the following:

- Analysing any patterns, trends, areas of success and improvement to alter current training and non-training interventions, in terms of content, delivery mode and method, weightage etc and to inform future training initiatives.
- Analysing observations and feedback received from officials to assess their engagement and application of knowledge.
- Summarizing participant feedback from surveys and feedback forms to identify strengths and areas for improvement, supplemented by analysis of pre-and post-training assessment scores to measure knowledge improvement achieved.

Reporting and Feedback Mechanism

Accountability and transparency is important to demonstrate progress, achievements, and challenges while training and non-training interventions are being implemented in the divisions and the department. This step in the process will help identify potential risks and challenges associated with the M&E process and ensure the sustainability and continuity of the implementation process. The reporting and feedback mechanism could entail:

- Preparation of periodic reports summarizing the findings of monitoring and evaluation
- Sharing of the reports with relevant stakeholders including senior officials of the Ministry and the Department
- Providing feedback to course conductors and facilitators to improve future training sessions
- Encouraging department officials to provide feedback and suggestions for enhancing the quality and effectiveness of training and non-training interventions

7.2. Monitoring and Evaluation Review Templates

It is proposed to use standard Monitoring and Evaluation templates to closely review applicability of each course as well its reception and feedback. It is proposed to institutionalize a M&E process through scorecards, feedback forms on the training and the non-training interventions being taken up at each Division along with a monthly review of the entire capacity-building exercise.

The Monitoring and Evaluation template is provided below. The same will be finalized in discussion with MoRTH, after finalization of priority courses for Year I.

Number of sanctioned staff:

Secretary	Additional Secretary	Joint Secretary	Deputy Secretary / Under Secretary	Director	Section Officer	Additional Section Officer	Total

	Name of the Training Course	Objective of the Training Program	Competency	Delivery	Training Partner Institution	Training Date	Duration	Participants	AS	JS	DS / US	Dir	SO	ASO	Total
1								Target							0
								Achievement							0
2								Target							0
								Achievement							0
3								Target							0
								Achievement							0

Annexures

Annexure-1: Copy of OM of formation of Capacity Building Unit (CBU), MoRTH

1780932/2022/NHIDCL

H-39011/44/2022-LogisticsCell

14/15

H-39011/44/2022 -Logistics Cell (210884)
Ministry of Road Transport & Highways
Transport Bhawan 1, Parliament Street, New Delhi

Dated: 13th December, 2022

OFFICE MEMORANDUM

Subject:-Workshop under the Chairman Ship of the Cabinet Secretary on framing of Annual Capacity Building Plans under "Karamyogi Mission".

In partial modification of OM No. H-39011/44/2022 -Logistics Cell (210884) dated 30th November 2022(Copy enclosed), the Capacity Building Unit (CBU), MoRTH is reconstituted with the following officials:-

1.
 1. Joint Secretary (Esstt.) Convener and Nodal Officer
 2. Joint Secretary (IAHE) Member
 3. Director (IAHE) Member
 4. Consultant to be appointed by CBC
2. The CBC can co-opt any other member as per need.
3. Accordingly all correspondence with respect to Capacity Building Unit, MoRTH is to be done at the following address:-

Joint Secretary (Establishment)
(Kind Attention: Shri Kamlesh Chaturvedi), Room No.323,
Ministry of Road Transport & Highways,
Parliament Street 1, New Delhi-110001.
E-Mail Address: k [dot] chaturvedi [at] gov [dot] in

4. This issues with the approval of the Competent Authority.

(Hans Raj Sharma)

Under Secretary to the Government of India,
Ministry of Road Transport & Highways.

To

Anita Bilung,
Under Secretary to the Government of India
Department of Personnel & Training.

Copy to:-

- i. Sr. PPS to Secretary, MoRTH
- ii. Joint Secretary (Esstt.), MoRTH
- iii. Joint Secretary (IAHE), MoRTH
- iv. Director, IAHE

Annexure-2: Minutes of meeting of Kickoff meeting with CBU

Date and venue	<ul style="list-style-type: none"> 8th February 2023 Transport Bhawan, 1 Sansad Marg, Delhi
Participants	<ul style="list-style-type: none"> Mr. Kamlesh Chaturvedi, Joint Secretary (Establishment), MoRTH Mr. SP Singh, Joint Secretary (Logistics & IAHE), MoRTH Mr. Sanjeev Kumar, Director (IAHE), MoRTH Ms. Shruti Arora, Director, PwC Mr. Rajat Bhushan, Manager, PwC
Agenda	<ul style="list-style-type: none"> Introduction to the project Detailed discussion on scope of work and work plan. Discussion on way forward

Key Discussion Points

- PwC Team presented the project objective, scope of services, work plan, support required from the Ministry and way forward.
- Joint Secretary (Logistics & IAHE) suggested the team should meet the senior officers of the Ministry to provide a brief on Mission Karma yogi, get an understanding of working, responsibilities of respective Wing/ Division, and take Their inputs regarding competencies required by the staff and skill gaps.
- Following officers were identified for MoRTH:
 - Shri P V S Ravi Prasad, DG Roads
 - Shri Sanjay Kumar, AS & FA
 - Shri Amit Kumar Ghosh, Additional Secretary (Highways)
 - Shri Mahmood Ahmed, Additional Secretary (RS, T, MVL, IT & NHIDCL)
 - Shri D Sarangi, ADG Roads
 - Shri Kamlesh Chaturvedi, Joint Secretary (Est.)
 - Shri SP Singh, Joint Secretary (Logistics & IAHE)
 - Shri Dinesh Kumar, DDG (TRW)
 - Shri VK Rajawat (CE Zone-1)
 - Shri Sudip Chaudhary (CE Planning)
 - Shri Kaushik Basu (CE Monitoring)
 - Shri Sanjeev Kumar (Director, IAHE)
 - RO (Lucknow), MoRTH
- Post discussion, a preliminary questionnaire would be circulated among the other officers to understand their current skills and undertake gap assessment.

Annexure-3: Record of Discussion for Stakeholder Consultation Questionnaire with CBU

Date and venue	<ul style="list-style-type: none"> • 18th May 2023 • Transport Bhawan, 1 Sansad Marg, Delhi
Participants	<ul style="list-style-type: none"> • Mr. Kamlesh Chaturvedi, Joint Secretary (Establishment), MoRTH • Mr. SP Singh, Joint Secretary (Logistics & IAHE), MoRTH • Mr. Sanjeev Kumar, Director (IAHE), MoRTH • Ms. Shruti Arora, Director, PwC • Mr. Rajat Bhushan, Manager, PwC • Ms. Jincy Chandeliya, Consultant, PwC
Agenda	<ul style="list-style-type: none"> • Presentation of the Questionnaire • Detailed discussion on scope of work and work plan. • Discussion on way forward

Key Discussion Points

1. A meeting of Capacity Building Unit (CBU), convened by Joint Secretary (Establishment) MoRTH was held on May 18th at 11:30 AM, for finalization of stakeholder consultation forms and review of progress of Preparation of Annual Capacity Building Plan (ACBP) for MoRTH.
2. The list of officers who attended the meeting is given in the Annexure.
3. Consultant (PwC) briefed the CBU on the progress of Preparation of Annual Capacity Building Plan (ACBP) for MoRTH.
4. The Stakeholder Consultation Forms were discussed in detail and the following suggestions were provided:

Functional Competencies

- a. JS (IAHE) suggested to add additional online portals such as PFMS, Bhoomirashi, CPGRAM, INGRAM etc. to the list of
- b. JS (Establishment) suggested to map functional competencies for Senior Officers (JS/CE and above) based on level of proficiency (Basic, Intermediate and Advanced).
- c. It was also advised to include Knowledge of Audit Paras and Court Cases in the functional competencies.

Behavioural Competencies

- a. Director (IAHE) suggested to replace written communication with verbal communication in the forms for ASO to Director, and merge similar behavioural competencies to make the forms concise.

- b. JS (IAHE) advised to merge health and awareness and stress management under a common header.

Domain Competencies

- a. Director (IAHE) suggested to incorporate additional domain skillset for AEE to SE including knowledge of Bridges and Tunnels, Alternate Transport Modes, and Public Private Partnerships etc.
- b. Director (IAHE) and JS (IAHE) suggested to add all Acts related to transport sector such as Carriageway Act, State Acts, ASRTU Guidelines etc. and assess knowledge on citizen centric applications including Vahan, Sarathi, e-Challan etc.
- c. JS (Establishment) advised to include knowledge on Medical Reimbursement, TA Rules, Leave Rules, Deputation Rules and DP Guidelines in forms of Establishment Division.

Way Forward:

- a. Office Memorandum to be circulated for Registration on iGOT Karma yogi Portal for online learning and registration of Government Employees.
- b. Office Memorandum to be circulated for employees ASO and Above for providing support and inputs for Stakeholder Consultations.
- c. An orientation meeting to be organized for officers (ASOs to Directors) to brief them about the consultation forms to ensure meaningful response from stakeholders.

Annexure-4: Key Schemes and Programmes

S. No	Scheme/ Programme	Focus Area	Brief Details	Hyperlink
Key Schemes				
1.	Economic Importance and Interstate Connectivity (EI&ISC) Schemes	Sanction and Monitoring of projects	<ul style="list-style-type: none"> The schemes cover the economic matters related to interstate connectivity. Criteria for allocation of funds for development of State Roads under the CRIF Act, 2000 	Hyperlink
2.	Road Safety Advocacy Scheme	Based on grants, proposals, initiatives by NGO to spread road safety.	<ul style="list-style-type: none"> To strengthen road safety various activities such as conferences, exhibitions and awareness campaigns are run by the Ministry to spread awareness and increase collective participation. Events such as National Road Safety week have been observed to ensure safety on road for all motorists. 	Hyperlink
3.	Satu Bandhan	Replacement of railway line level crossings with road over bridges	<ul style="list-style-type: none"> Under the Setu Bandhan scheme of the Ministry, replacement of railway line Level Crossings (LCs) with Road Over Bridges (ROBs)/Rail Under Bridges (RUBs) through CRIF on State roads/MDR/ODR will be done. Allocation of fund for the year 2022-23 under this scheme is Rs.1326 crore. 	Hyperlink
4.	Compensation to Victims of Hit and Run Motor Accidents Scheme	Providing comfort to the victims of Hit and Run case.	<ul style="list-style-type: none"> The Ministry announced a new Hit and Run compensation system for victims of road accidents, for enhanced allowance (of Rs. 12,500 Rs 50,000 in case of serious bodily injury and Rs 25,000 in case of death Rs 2,00,000). A deadline was also set for claims for damages and the release of compensation for victims. This scheme will replace the 1989 Solatium scheme from 1 April 2022 	Hyperlink
5.	Strengthening ITS in Public Transport System	The Ministry updated its previous ITS plan and published guidelines on 23 June 2022 continue the previous pattern. It provides additional	<ul style="list-style-type: none"> The Scheme provides support of hardware and software components for Fleet Management System, Electronic Ticketing & Fare 	Hyperlink

S. No	Scheme/ Programme	Focus Area	Brief Details	Hyperlink
		financial support to STUs for their equipment itself using advanced intelligent transport system technologies, advanced bus services, features, performance and customer amenities.	<p>Collection System (including NCMC) and Passenger Information & Feedback System.</p> <ul style="list-style-type: none"> The Transport Bodies such as State Transport Undertakings, State Transport Corporations, Public Private Partnerships and State Government Bodies (including hilly regions and North-east States) are eligible to avail the financial assistance under the Scheme. 	
6.	Setting Up of Driving Training Centers	<p>To provide financial assistance to private parties for the establishment of a company Driving training centers.</p> <p>To provide quality training to commercial vehicles for road improvement and environmental safety and improves overall mobility on roads.</p>	<ul style="list-style-type: none"> The driving training center is a center for the development of physical skills infrastructure that requires capital expenditures (CAPEX) to create and develop. of the necessary infrastructure. Infrastructure is land, building, lanes, vehicles, simulators, and workshop etc. The center does require regular operating expenses (OPEX) to run its day-to-day operations and provide labor. Training programs are meeting the National Skills Qualification Framework (NSQF), informant Ministry of Skill Development and Entrepreneurship 	Hyperlink
7.	Setting up Institute for Driver Training and Research	<p>Ministry promotes to set up Institute for Driver and Training and research to educate drivers for safer driving's. This is also an attempt to reduce accidents in future.</p>	<ul style="list-style-type: none"> A good "driver training institute" tries to develop the right attitudes to driving duties, encourages an understanding of traffic rules and create good driving habits. Just listen or read, drive skills cannot be acquired. Everyone has to learn the skills themselves own practice. Random learning never promises high skill. If young managers are trained systematically, they know how to correct their mistakes and helps reduce accidents. If drivers are not properly trained, eventually the public puts themselves at risk by their mistakes. Sound director training and practice pays. Properly educated new generation Drivers would significantly reduce accidents 	Hyperlink

S. No	Scheme/ Programme	Focus Area	Brief Details	Hyperlink
			in the future.	
8.	Setting up inspection and certification centers	<p>With a rapidly growing economy, the number of vehicles in India has increased.</p> <p>The Government of India has set emission standards for motor vehicles in India since 1991 and updated emission and safety standards to new one's vehicles.</p> <p>Each vehicle prototype undergoes extensive laboratory tests before putting them on the market.</p>	<ul style="list-style-type: none"> • For effective implementation of an I&C regime in India, the following various aspects should be considered. • Institutional structure • Programme content • Auditing of the Vehicle • Inspection Centers • Enforcement on road • Data Collection and analysis and • Networking of centers • Human Resource Development • Public Awareness Programs • Maintenance Program • Legislative reform 	Hyperlink
9.	Scheme for Grant to Good Samaritan	<p>Any individual who saved the life of a victim including a motor vehicle aids the victim will be granted a sum of amount state as per the scheme and other conditions</p>	<ul style="list-style-type: none"> • MORTH started the plan: "A scheme to reward the Good Samaritan who saved the life of a victim of a fatal motor vehicle accident by providing immediate assistance help and rush to the hospital/trauma center at the prime time of the accident provide medical care." • Under this system, good Samaritans are encouraged to do so Good Samaritan acts are encouraged. 	Hyperlink
10.	Development of Bus Ports in States/UTs on BOT/HAM basis	<p>To promote efficient mobility, this scheme focuses on increasing the capacity of the bus terminals for public benefit.</p>	<ul style="list-style-type: none"> • The system aims to improve the ability and the quality of the bus terminal infrastructure benefits users of public bus transport by providing these safe, convenient, and user-friendly pick-up and drop-off points and better passengers amenities • One goal is to bring private actors into the mainstream by enabling them access to bus ports. • Under this scheme, proposed projects in Tamil Nadu were approved in principle (Salem), Odisha (Cuttack), Uttarakhand (Ramnagar), Himachal Pradesh (Baddi), UT of Chandigarh, Andaman and Nicobar University, Haryana (Sonipat), Kerala (Trivandrum), Tripura (Udaipur), Punjab (Patiala), 	Hyperlink

S. No	Scheme/ Programme	Focus Area	Brief Details	Hyperlink
			<p>Jammu (Katra), Maharashtra (Pune). Project for development</p> <ul style="list-style-type: none"> A bus terminal at Ramnagar (Uttarakhand) has been approved 	
11.	Safety and Security of Women Passengers (Projects under Nirbhaya Framework)	Ensuring safety for women has been a top goal for Ministry. To provide easy transfer and safer travels various initiatives have been taken by MoRTH.	<ul style="list-style-type: none"> The Government of India has established a special fund under the Nirbhaya framework administered by the Ministry of Finance of the Ministry of Finance. Sanctioned by this Ministry financial assistance from Nirbhaya Fund to States/UTs for specially designed projects to improve the safety of women in public transport after evaluation and recommendation Commission authorized by the Ministry of Women and Child Development. independent projects of Andhra Pradesh Government, Uttar Pradesh State Road Transport Corporation and Bangalore Metropolitan Transport Corporation were endorsed by the Nirbhaya Foundation Program to increase the safety of women in public traffic in different stages of implementation. 	Hyperlink
12.	Development of State-wise Vehicle Tracking Platform in States/UTs (under Nirbhaya Framework)	Women safety is a national concern. In order to reduce crime against women, this initiative is a key goal of the Ministry.	<ul style="list-style-type: none"> The proposed system aims to improve the safety of women and girls Monitoring Centers in various states/UTs monitoring all these Public Service Vehicles (PSV). It is equipped with a location tracker and emergency buttons to sound an alarm crisis The monitoring center monitors and coordinates them with the ERSS of the country respond to emergency calls. 	Hyperlink
Key Programmes / Initiatives				
1.	Bharatmala Pariyojna	<p>It is a key programme to strengthen the connectivity within the country and borders.</p> <p>Currently Phase 1 is under construction. It covers a</p>	<ul style="list-style-type: none"> This includes development of – Economic Corridors Inter-Corridors & feeder roads National Corridor Efficiency improvement 	Hyperlink

S. No	Scheme/ Programme	Focus Area	Brief Details	Hyperlink
		lot of key projects.	<ul style="list-style-type: none"> • Border & International connectivity roads • Coastal & port connectivity roads • Expressways • Ongoing Projects, including NHDP 	
2.	SARDP-NE (Phase A+ Arunachal Pradesh Package)	The scheme is envisaged into three parts – Phase A, Phase B, and Arunachal Pradesh Package	<ul style="list-style-type: none"> • Phase A of SARDP-NE approved by the government involves improvement of about 4,099 km of roads (3,014 km of NH and 1,085 km of national highways). Of these, 3,213 kilometers of roads have been approved for implementation and the remaining 886 kilometers are "in principle" • SARDP-NE Phase B covers 3723 km by road (2210 km NH and 1513 km national highways). Phase B SARDP-NE will be implemented after the completion of Phase A. • Arunachal Pradesh Package: The Government has also approved the Roads and Highways Package for Arunachal Pradesh which includes the development of about 2319 km of roads (2205 km of NH and 114 km of State/Headquarters/Strategic roads). 776 kilometers of projects are envisaged under BOT (Annuity) mode and the rest will be developed under EPC mode/part contract as per the existing policy of the Ministry. 	Hyperlink
3.	LWE (including Vijayawada Ranchi Route)	LWE areas are sensitive areas with respect to development. The Ministry aims to provide efficient mobility in all areas and terrains. To ensure the same various plans are initiated and special budget is allocated to achieve the same.	<ul style="list-style-type: none"> • The government has approved a plan to develop about 1,177 km of NHs and 4,276 km of national highways as a special project in Left Wing Extremism (LWE) affected areas at a cost of about Rs. 7300 crores. • As on 31 March 2019, detailed estimates for a length of 5,422 km at an estimated cost of Rs. 	Hyperlink

S. No	Scheme/ Programme	Focus Area	Brief Details	Hyperlink
			8,674 crores, of which runs on 5,419 km and costs Rs. 8.739 crore are given.	
4.	National Highway Development Program	Key focus is to build more national highways, Enhanced safety features, Divided carriageways, and Service roads. Better Riding Surface, Grade separators, Better Road Geometry, Over bridges and Underpasses, Better Traffic Management and Noticeable Signage, Bypasses and Wayside Amenities	<ul style="list-style-type: none"> • The program covers development of National Highways in the country to boost economic development in the country. • The NHDP represents approx. 49,260 km of roads and highways work. • It is divided into 7 phases. • Some advantages of NHDP are – • Savings in vehicle operating costs • Benefits to trade especially in movement of perishable material • Faster, comfortable journeys • Reduced maintenance costs • Reduced fuel consumption • Safer travel • All round development of areas 	Hyperlink
5.	Char Dham Pari yojana	Ministry has also taken initiative to improve the travel for spiritual Char Dham Yatra. A proper plan has been proposed to develop the same.	<ul style="list-style-type: none"> • The Ministry launched a separate program to improve the connectivity of Char-Dham (Kedarnath, Badrinath, Yamunothri and Gangotri) in Uttarakhand. Out of 53 construction works of Chardham project covering a total length of 889 km, 40 construction works have a total cost of Rs. 9,474 kroner (including a pre-construction cost of 491 kroner) was allocated for the 673 km length. 	Hyperlink
6.	Construction of MMLPs	The Ministry aims to strengthen the logistic network along with the development of National Highways. Currently 35 projects are taken into consideration.	<ul style="list-style-type: none"> • The 35 MMLPs implemented by MORTH are to be developed under Public Private Partnership (PPP) in Design, Build, Finance, Operate and Transfer (DBFOT) mode. • The tender documents for these 35 MMLPs (Model Concession Agreement and Request for Tenders) have been finalized. • Tenders are invited from companies based on the results of the DPR/feasibility studies and the approved procurement document. 	Hyperlink

S. No	Scheme/ Programme	Focus Area	Brief Details	Hyperlink
7.	Parvaramala Yojana	Developing transport system in areas of difficult terrains and promoting sustainability	<ul style="list-style-type: none"> • Currently there are 4 ropeways in the country – • Gulmarg Gondola Cable Car, Jammu • Bi-cable Zig-back Ropeway, Gangtok • Mansapurna Karni Mata Ropeway, Udaipur • Aerial Ropeway, Nainital 	Hyperlink
8.	Automotive reforms	Automotive norms focus on safe driving, reduced emission, lesser pollutions through vehicles,	<ul style="list-style-type: none"> • Mandatory fitment of ABS in two-wheelers (L2 category) with engine capacity greater than 125 cc. • Mandatory fitment of Anti-lock Braking System (ABS) or Combined Braking System (CBS) in two-wheelers (L2 category) with engine capacity less than 125 cc • Fitment of reverse parking sensor • Seat Belt Reminder for driver and co-driver. • Front airbag for driver • Manual Override for central locking door • Overspeed Warning system 	Hyperlink